

VTT9812FH and VTT9814FH

IR-Bloc™ Ambient Light Sensor

IR-Blocking Silicon Phototransistor



The IR-Bloc™ family is the only ambient light sensor family on the market that comes in a low cost package with the IR-blocking feature incorporated in a plastic epoxy package. The spectral response is similar to the human eye and a photocell, making it ideal for applications where the response should only be influenced by the visible light.

As part of the IR-Bloc family of ambient light sensor, the VTT9812FH and the VTT9814FH are silicon phototransistors in a standard flat T-1 ¼ end-looking package. They offer the time-proven VTT silicon phototransistor chip that customers have come to rely upon over the years, with the additional IR blocking feature incorporated in the plastic epoxy package. As such they give an excellent response in the visible spectral range, giving a RoHS-compliant alternative to Cadmium Sulphide photocells.

The VTT9812FH is specified for dusk/dawn switching at low light levels around 0.2 to 1fc (2 to 10lux).

The VTT9814FH, with its narrow light current tolerance, is especially suited for ambient light control applications around 50 to 100fc (500 to 1000lux).

Key Features

- Visible light response with IR-blocking feature incorporated in the cast epoxy
- RoHS-compliant alternative to photocells
- Low dark current

Applications

- Street light switching
- Interior and exterior light control (dusk/dawn switch)
- Automotive headlight dimmer
- Contrast control

IR-Blocking Silicon Phototransistor

General Characteristics and Electro-optical specifications at 25°C

Parameter	Min	Typical	Max	Units	Conditions
Storage Temperature	-40		100	°C	
Operating Temperature	-40		100	°C	
Maximum Continuous Power Dissipation		50		mW	
Maximum Current		25		mA	
Dark Current		1	50	nA	$V_{CE} = 5V, 0fc$
Collector Breakdown	30			V	$I_C = 100\mu A, 0fc$
Emitter Breakdown	2.1			V	$I_E = 100\mu A, 0fc$
Saturation Voltage			0.25	V	$I_C = 1mA, 400fc$
Rise/Fall Time		1.5		μs	$I_C = 1mA, R_L = 100k\Omega$
Peak Spectral Response		585		nm	
Sensitivity at peak		7		A/W	
Angular Response		± 50		°	At 50% response
Soldering Temperature			260	°C	5 seconds maximum
VTT9812FH					
Short Circuit Current	60			μA	100fc, 2850K, $V_{CE} = 5V$
VTT9814FH					
Short Circuit Current	80		120	μA	100fc, 2850K, $V_{CE} = 5V$

Typical Spectral Sensitivity at 25°C

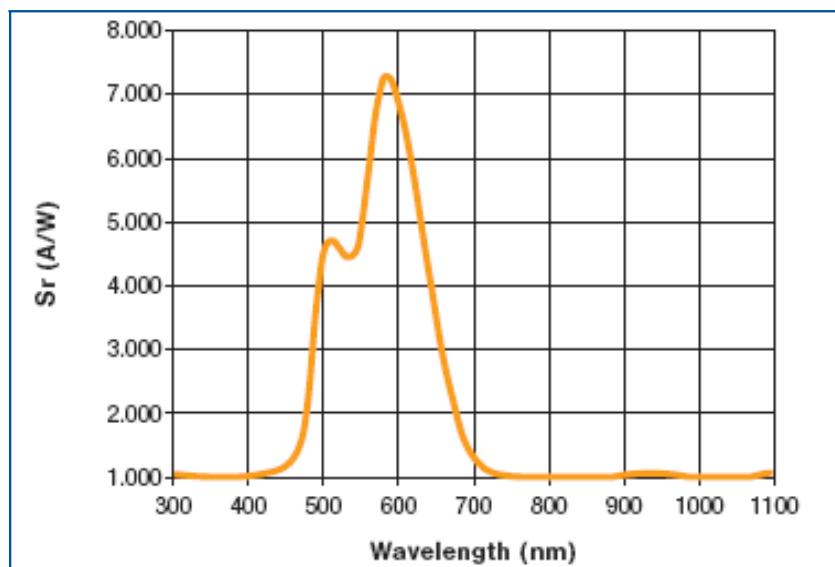

IR-Blocking Silicon Phototransistor

Typical Angular Response

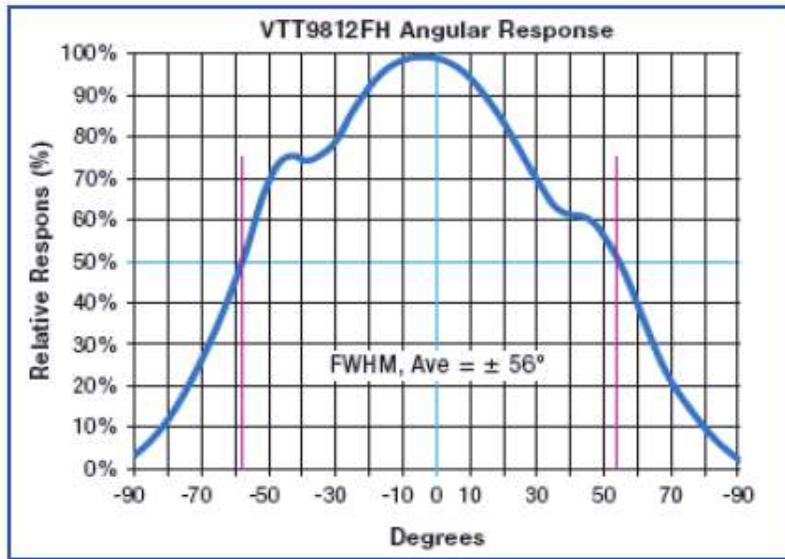

VTT9812FH Output Light Current vs Light Level with min/max bands

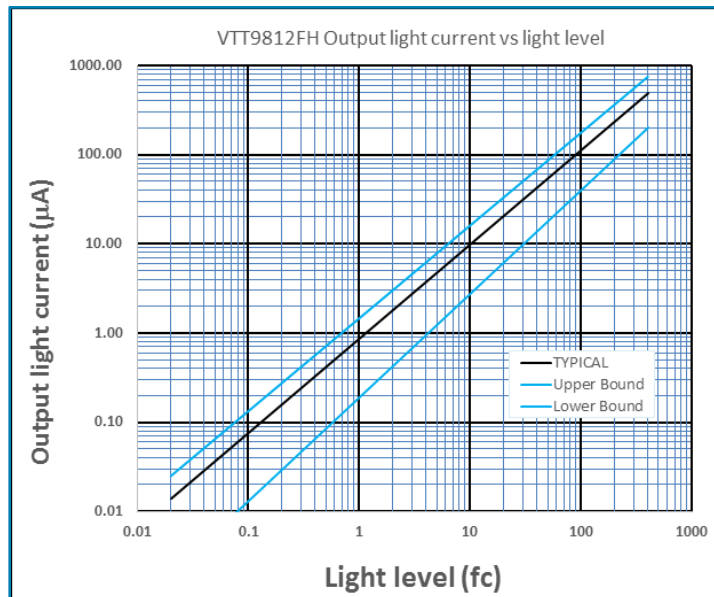

VTT9812FH and VTT9814FH
IR-Blocking Silicon Phototransistor

VTT9814FH Output Light Current vs Light Level with min/max bands

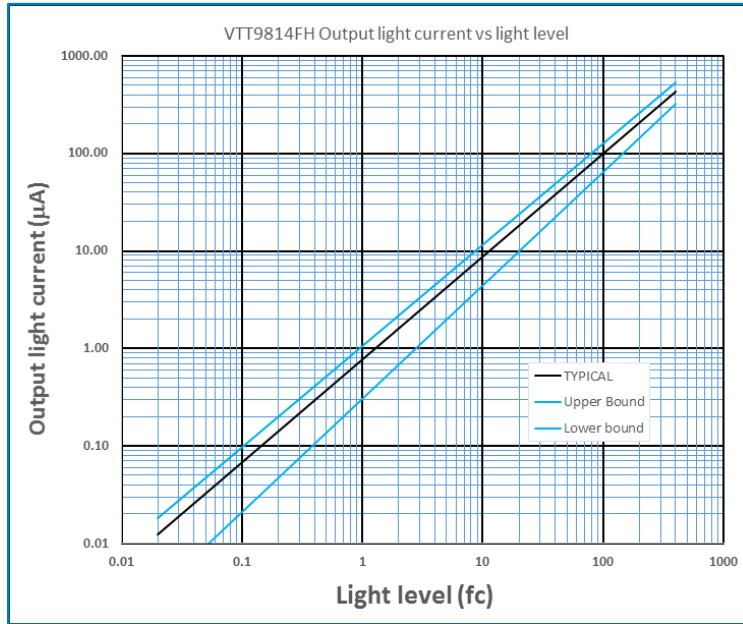

Typical Photocurrent Change vs Temperature at Different Light Levels – Normalized to 25°C

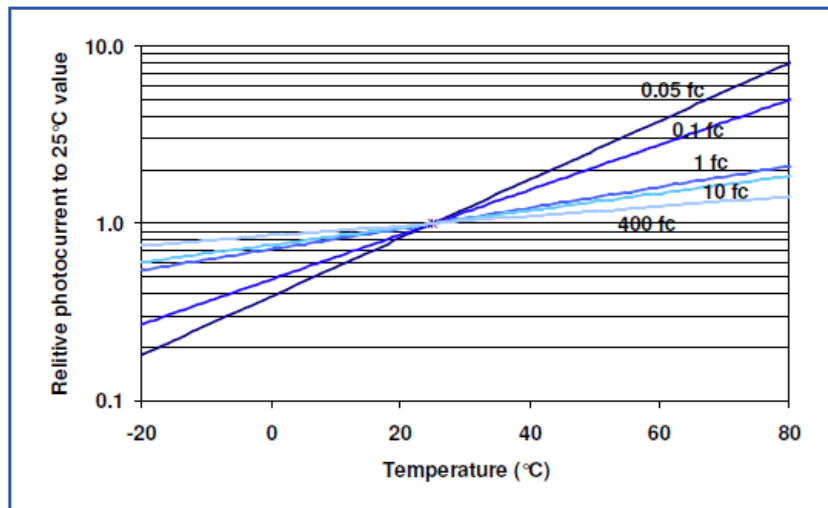

Variation of Dark Current with temperature

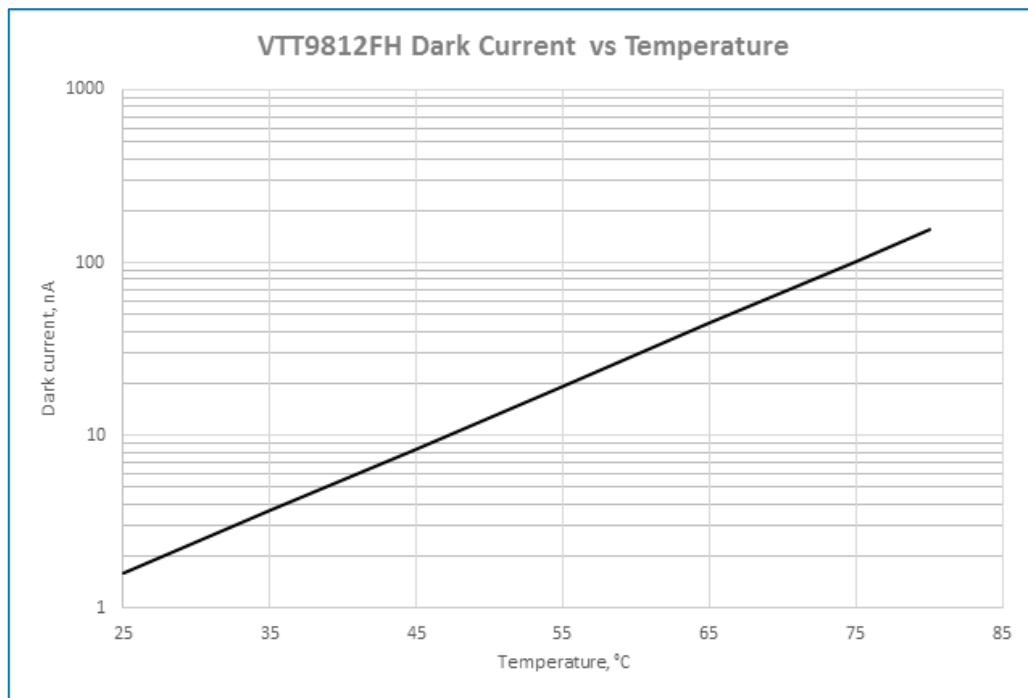

VTT9812FH and VTT9814FH

IR-Blocking Silicon Phototransistor

Mechanical Characteristics

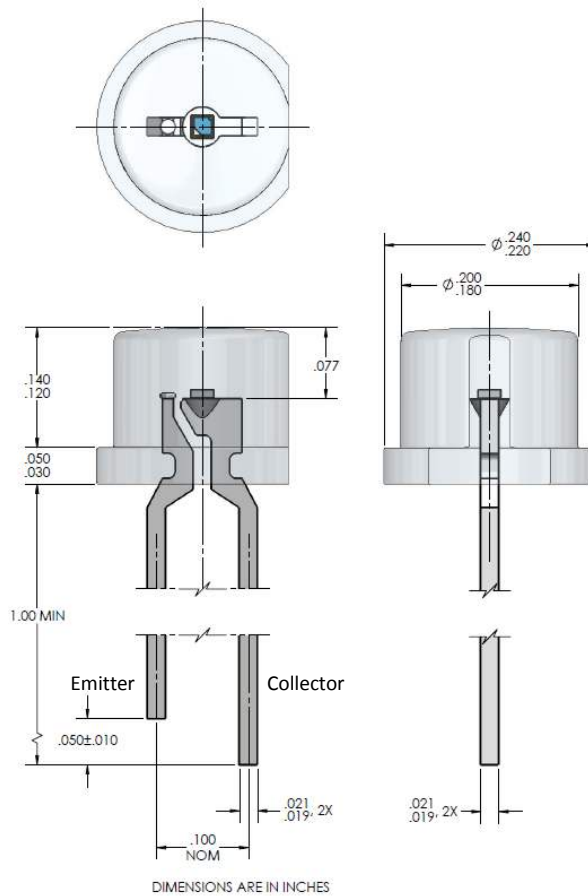

About Excelitas Technologies

Excelitas Technologies is a global technology leader focused on delivering innovative, customised solutions to meet the lighting, detection and other high-performance technology needs of OEM customers.

From analytical instrumentation to clinical diagnostics, medical, industrial, safety and security, and aerospace and defense applications, Excelitas Technologies is committed to enabling our customers' success in their specialty end-markets. Excelitas Technologies has approximately 5,000 employees in North America, Europe and Asia, serving customers across the world.

Excelitas Technologies
22001 Dumberry Road
Vaudreuil-Dorion, Quebec
Canada J7V 8P7
Telephone: (+1) 450.424.3300
Toll-free: (+1) 800.775.6786
Fax: (+1) 450.424.3345
detection@excelitas.com

European Headquarters
Excelitas Technologies
GmbH & Co. KG
Wenzel-Jaksch-Str. 31
D-65199 Wiesbaden
Germany
Telephone: (+49) 611 492 430
Fax: (+49) 611 492 165
detection.europe@excelitas.com

Excelitas Technologies
Singapore, Pte. Ltd.
8 Tractor Road
Singapore 627969
Telephone: (+65) 6775 2022
(Main number)
Telephone: (+65) 6770 4366
(Customer Service)
Fax: (+65) 6778-1752
detection.asia@excelitas.com

EXCELITAS
TECHNOLOGIES

For a complete listing of our global offices, visit www.excelitas.com/ContactUs

© 2015 Excelitas Technologies Corp. All rights reserved. The Excelitas logo and design are registered trademarks of Excelitas Technologies Corp. All other trademarks not owned by Excelitas Technologies or its subsidiaries that are depicted herein are the property of their respective owners. Excelitas reserves the right to change this document at any time without notice and disclaims liability for editorial, pictorial or typographical errors.