

Differential RF Amplifier, 75 Ω 5 - 1218 MHz



MAAM-011163

Rev. V7

Features

- Single Stage, Differential Amplifier
- 5 V, 290 mA Operation
- 19 dB Flat Gain
- Low Noise
- Low Distortion Performance
- Configurable as a single stage TIA for optical applications
- ESD Class 1B for HBM
- Lead-Free SOIC-8EP Plastic Package
- Halogen-Free “Green” Mold Compound
- RoHS* Compliant

Description

The MAAM-011163 is high gain, high linearity and low noise differential RF amplifier assembled in a SOIC-8EP plastic package. This amplifier provides 19 dB of flat gain with very low noise figure. The differential push-pull topology provides superior 2nd order intermodulation performance.

The MAAM-011163 provides high gain, low noise and low distortion making it ideally suited for 75 Ω infrastructure applications.

The MAAM-011163 can be configured with input from a photo diode for optical receiver applications. Having a typical EIN of 3.5pA/ $\sqrt{\text{Hz}}$ and excellent output return loss. While having high gain of 23 dB typical.

Functional Schematic

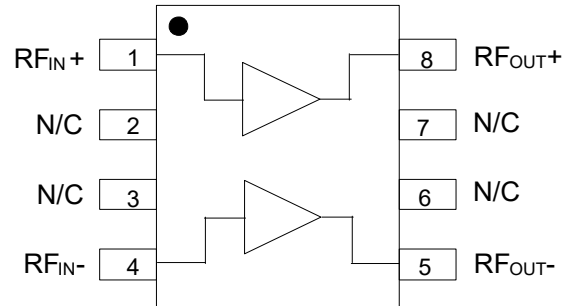

Pin Configuration

Pin #	Pin Name	Function
1	RF _{IN+}	RF Input +
2, 3	N/C	No Connection
4	RF _{IN-}	RF Input -
5	RF _{OUT-}	RF Output - / V _{DD}
6, 7	N/C	No Connection
8	RF _{OUT+}	RF Output + / V _{DD}
9	Pad ³	RF and DC Ground

3. The exposed pad centered on package bottom must be connected to RF and DC ground.

Ordering Information^{1,2}

Part Number	Package
MAAM-011163	Bulk Packaging
MAAM-011163-TR1000	1000 piece reel
MAAM-011163-TR3000	3000 piece reel
MAAM-011163-001SMB	Sample Board, 45 - 1218 MHz
MAAM-011163-002SMB	Sample Board, 5 - 300 MHz

1. Reference Application Note M513 for reel size information.
2. All sample boards include 5 loose parts.

* Restrictions on Hazardous Substances, compliant to current RoHS EU directive.

1

MACOM Technology Solutions Inc. (MACOM) and its affiliates reserve the right to make changes to the product(s) or information contained herein without notice. Visit www.macom.com for additional data sheets and product information.

For further information and support please visit:
<https://www.macom.com/support>

DC-0011769

Differential RF Amplifier, 75 Ω 5 - 1218 MHz



MAAM-011163

Rev. V7

Electrical Specifications: $T_A = 25^\circ\text{C}$, $V_{DD} = 5\text{ V}$, $Z_0 = 75\ \Omega$

Performance specified with input/output balun MABA-009210-CT1760.

Parameter	Test Conditions	Units	Min.	Typ.	Max.
Gain	1218 MHz	dB	18.4	19.0	20.4
Tilt	45 - 1218 MHz	dB	—	0	—
Reverse Isolation	45 - 1218 MHz	dB	—	22	—
Input Return Loss	45 - 1218 MHz	dB	—	20	—
Output Return Loss	45 - 1218 MHz	dB	—	20	—
Noise Figure	45 MHz 1218 MHz	dB	—	1.4 2.4	—
Output IP2	45 - 1218 MHz, tone spacing 6 MHz P_{OUT} per tone = +13 dBm	dBm	—	62	—
Output IP3	45 - 1218 MHz, tone spacing 6 MHz P_{OUT} per tone = +13 dBm	dBm	—	42	—
P1dB	45 - 1218 MHz	dBm	—	25	—
Composite Triple Beat, CTB	79 channels, 0 dB Tilt, 39 dBmV per channel output, QAM to 1000 MHz	dBc	—	-72	—
Composite Second Order, CSO	79 channels, 0 dB Tilt, 39 dBmV per channel output, QAM to 1000 MHz	dBc	—	-75	—
I_{DD}	$V_{DD} = 5\text{ V}$	mA	—	290	345

Absolute Maximum Ratings^{4,5,6}

Parameter	Absolute Maximum
Input Power	10 dBm
Operating Voltage	8 V
Operating Temperature	-40°C to +85°C
Storage Temperature	-65°C to +150°C
Junction Temperature ⁷	150°C

- Exceeding any one or combination of these limits may cause permanent damage to this device.
- MACOM does not recommend sustained operation near these survivability limits.
- Operating at nominal conditions with $T_J < 150^\circ\text{C}$ will ensure $MTTF > 1 \times 10^6$ hours.
- Junction Temperature (T_J) = Case Temperature (T_C) + $\Theta_{JC} \cdot (V \cdot I)$
Typical thermal resistance (Θ_{JC}) = 29°C/W.
 - For $T_C = 25^\circ\text{C}$,
 $T_J = 67^\circ\text{C}$ @ 5V, 290 mA
 - For $T_C = 85^\circ\text{C}$,
 $T_J = 121^\circ\text{C}$ @ 5V, 245 mA

Handling Procedures

Please observe the following precautions to avoid damage:

Static Sensitivity

Integrated Circuits are sensitive to electrostatic discharge (ESD) and can be damaged by static electricity. Proper ESD control techniques should be used when handling these (HBM) Class 1B devices.

Recommended PCB Layout

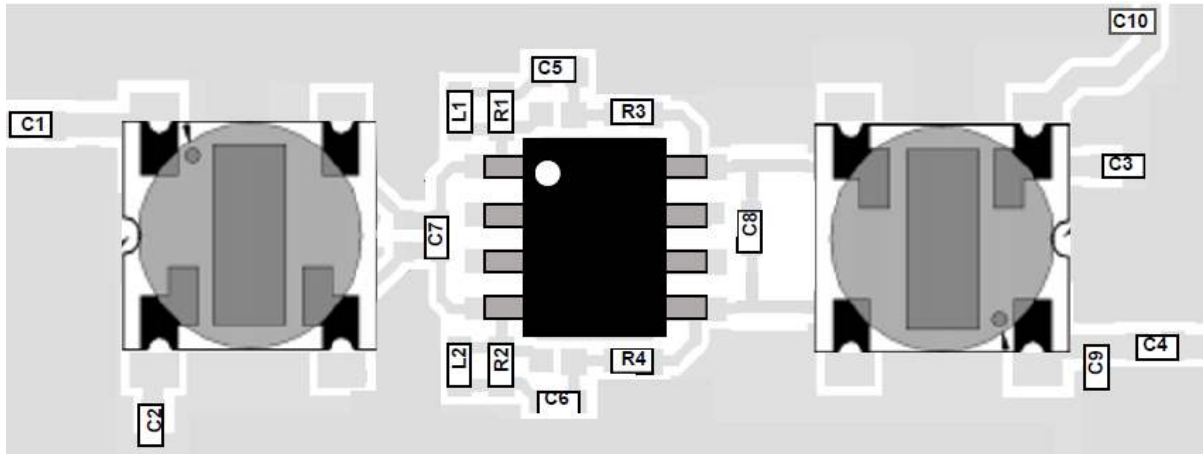

Schematic Including Off-Chip Components

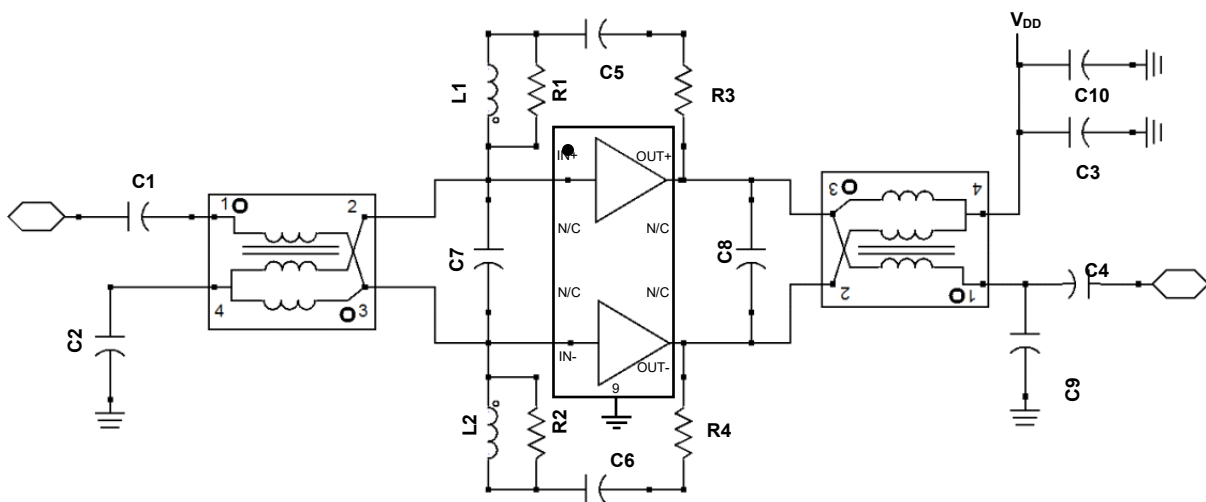

Parts List

Component	Value	Package	Component	Value	Package
C1, C4	270 pF	0402	L1, L2	33 nH	0402
C2, C3, C5, C6, C10	10 nF	0402	R1, R2	82 Ω	0402
C7	0.5 pF	0402	R3, R4	374 Ω	0402
C8	1.2 pF	0402	T1, T2	1:1 Balun ⁸	—
C9	Do Not Install	0402			

8. MABA-009210-CT1760

Differential RF Amplifier, 75 Ω 5 - 1218 MHz



MAAM-011163

Rev. V7

Typical Performance Curves: $V_{DD} = 5\text{ V}$

Gain

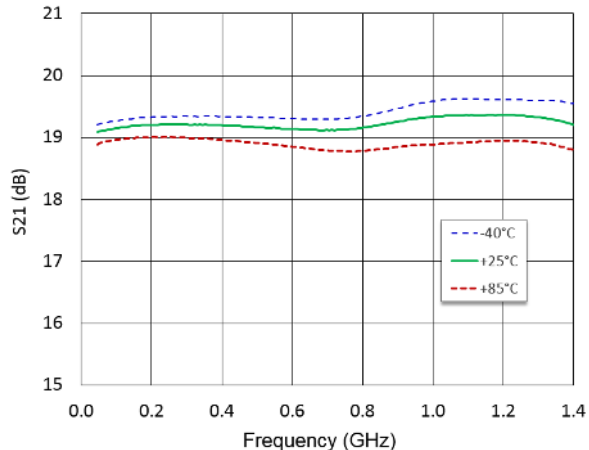

Gain to 3 GHz

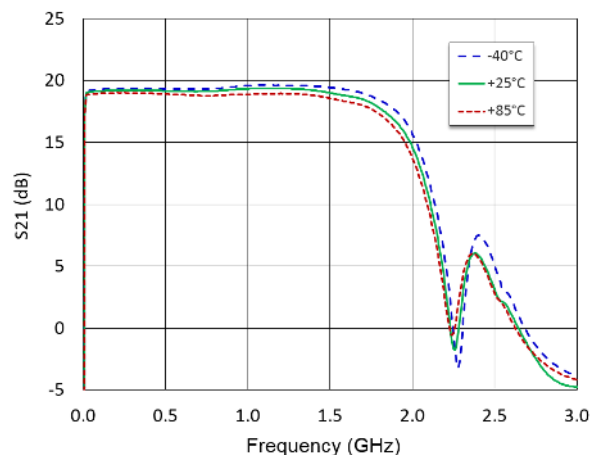

Input Return Loss

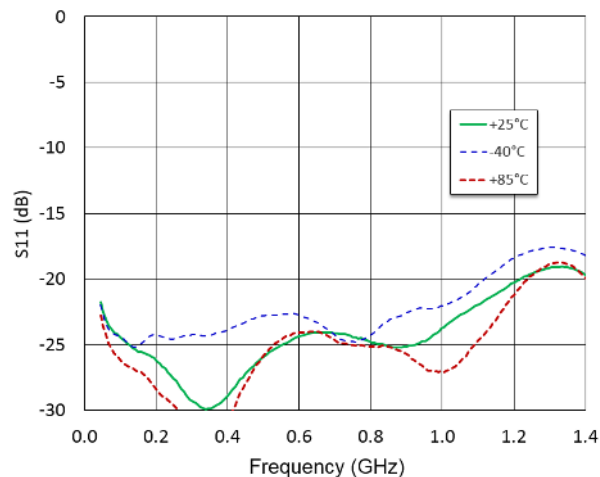

Output Return Loss

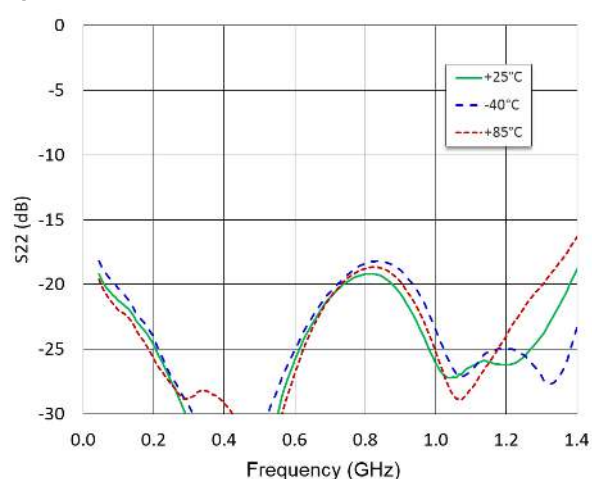

Reverse Isolation

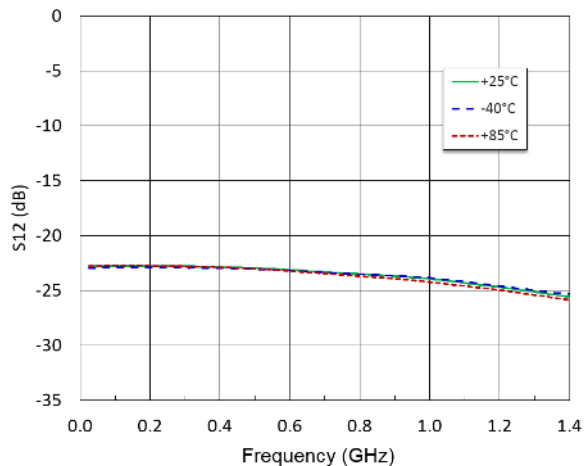

Noise Figure

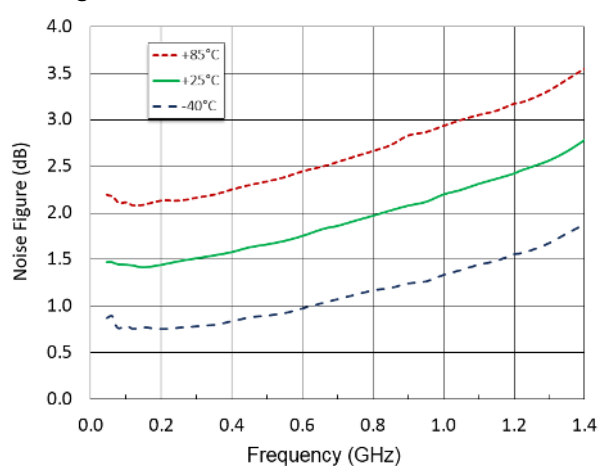

Differential RF Amplifier, 75 Ω 5 - 1218 MHz



MAAM-011163

Rev. V7

Typical Performance Curves: $V_{DD} = 5\text{ V}$

OIP3, $P_{OUT} = +13\text{ dBm/tone}$

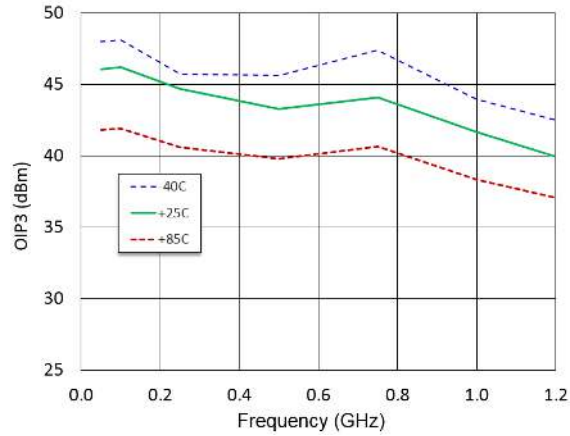

OIP2, $P_{OUT} = +13\text{ dBm/tone}$

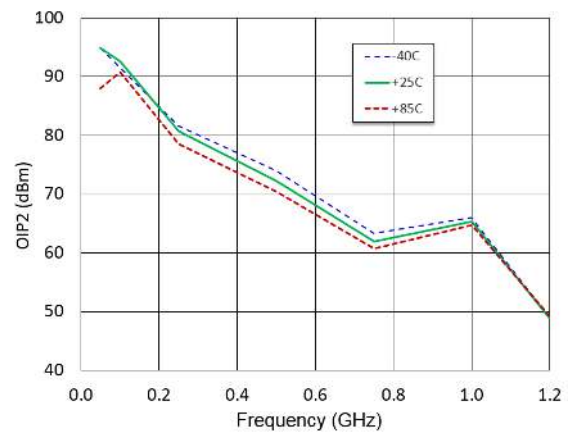

**CSO Lower, 79 channels + QAM to 1 GHz,
0 dB tilt, 39 dBmV per channel**

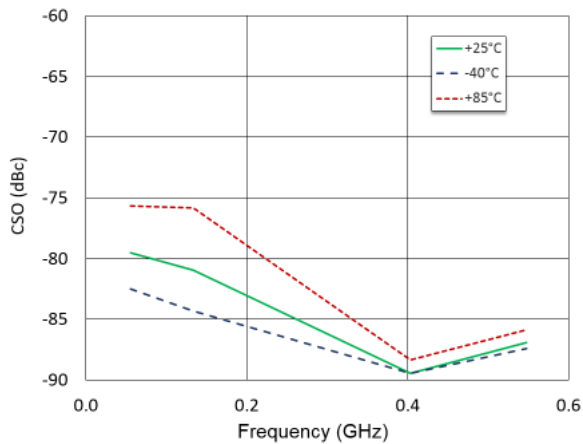

**CSO Upper, 79 channels + QAM to 1 GHz,
0 dB tilt, 39 dBmV per channel**

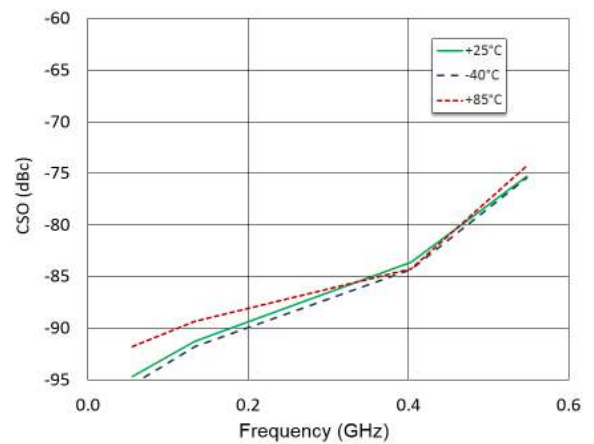

**CTB, 79 channels + QAM to 1 GHz,
0 dB tilt, 39 dBmV per channel**

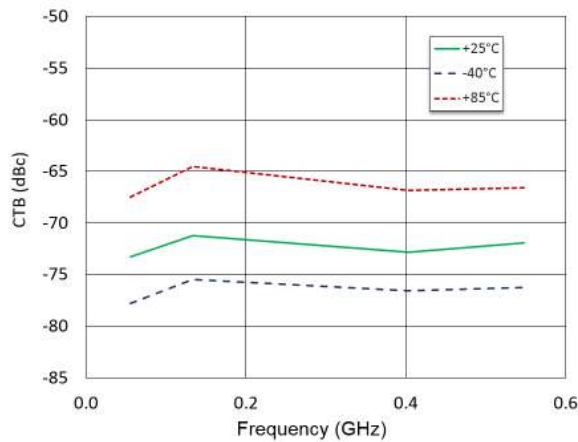

P1dB

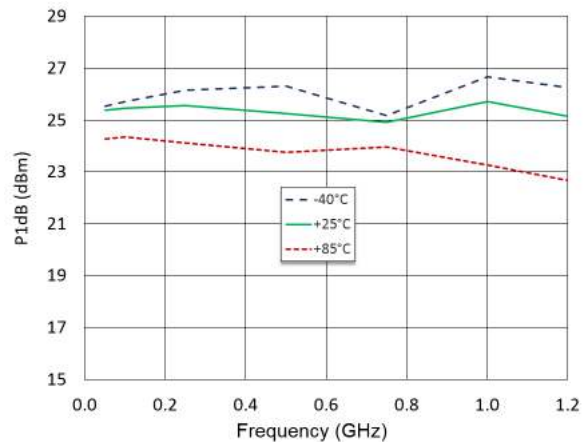

Differential RF Amplifier, 75 Ω

5 - 1218 MHz



MAAM-011163

Rev. V7

SOIC-8EP[†]

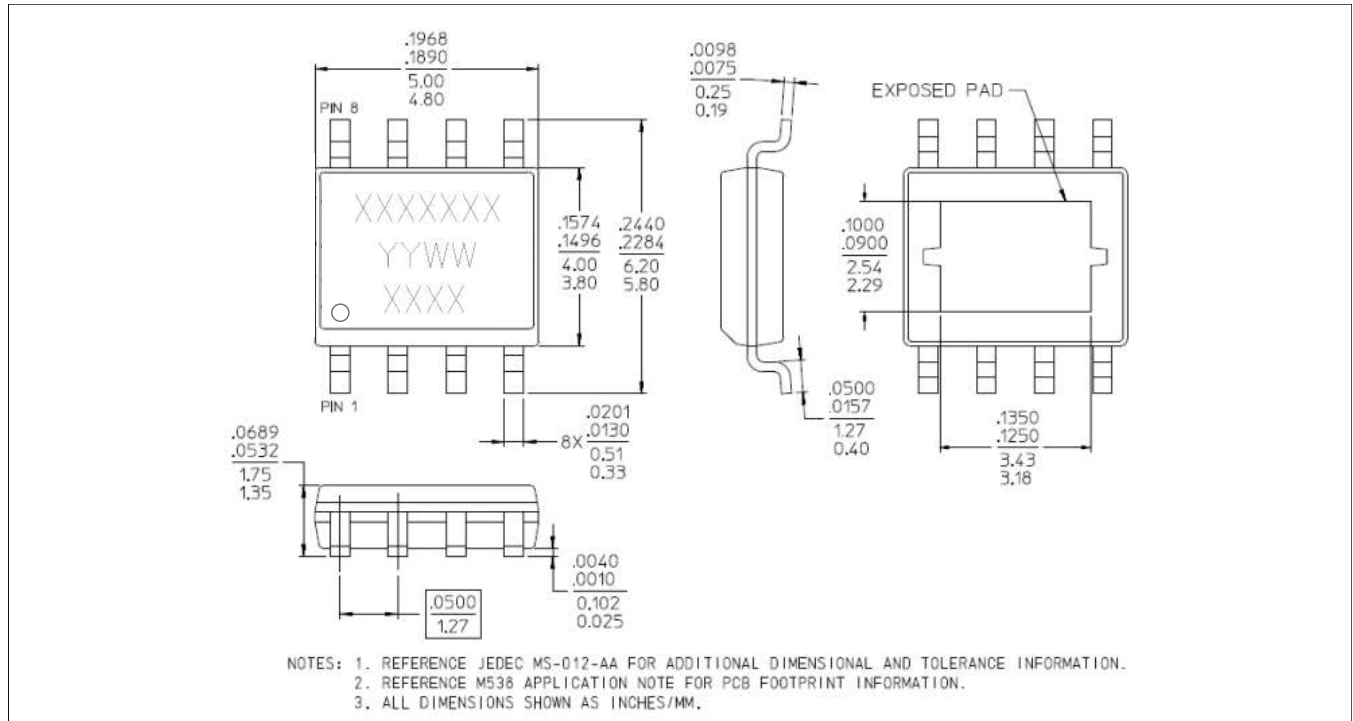

[†] Reference Application Note S2083 for lead-free solder reflow recommendations.
 Meets JEDEC moisture sensitivity level 1 requirements.
 Plating is 100% matte tin over copper.

Recommended PCB Land Pattern

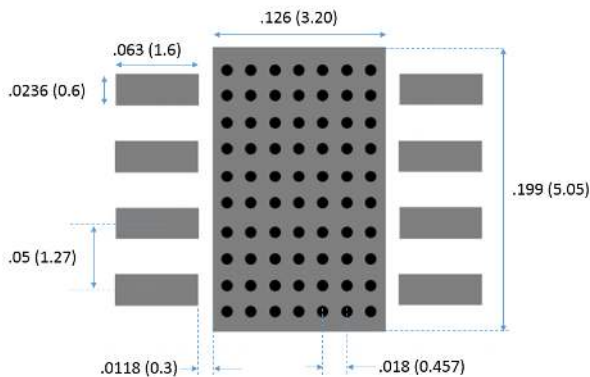

70 ground vias
 0.008 inch finished hole diameter
 All dimensions shown as inches (mm)

Applications Section: 5 - 300 MHz Application

The MAAM-011163 may be tuned for operation in the 5 - 300 MHz band for CATV reverse path (upstream) applications using an alternate balun and other external tuning components as identified in the table below. The recommended PCB layout and schematic are the same as identified on page 3. This tune can also be used from 5MHz up to 1200MHz, making it the ideal circuit for full duplex applications.

Recommended PCB Layout for Upstream

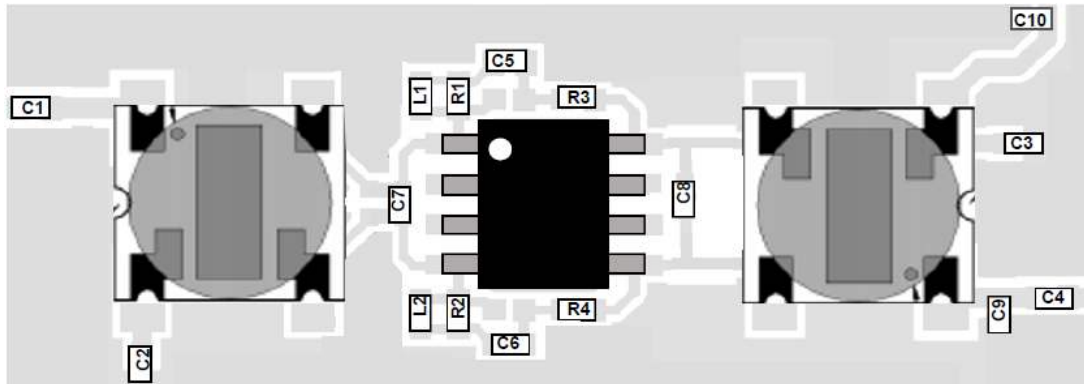

Parts List : 5 - 300 MHz Tune

Component	Value	Package	Component	Value	Package
C1 ,C2,C5,C6	10 nF	0402	C10	2.2 nF	0402
C3	100 nF	0402	L1, L2	33 nH	0402
C4	6.8 nF	0402	R1, R2	82 Ω	0402
C7	0.5 pF	0402	R3, R4	392 Ω	0402
C8	1.2 pF	0402	T1, T2	1:1 Balun ⁹	—
C9	Do Not Install	0402			

9. MABA-011085

Electrical Specifications: 5 - 300 MHz Tune, $T_A = 25^\circ\text{C}$, $V_{DD} = 5\text{ V}$, $Z_0 = 75\ \Omega$

Parameter	Test Conditions	Units	Min.	Typ.	Max.
Gain	—	dB	—	19.5	—
Reverse Isolation	—	dB	—	22	—
Input Return Loss	—	dB	—	22	—
Output Return Loss	—	dB	—	22	—
Noise Figure	5 - 10 MHz 20 - 300 MHz	dB	—	2.5 1.5	—
Output IP2	tone spacing 6 MHz, P_{OUT} per tone = +13 dBm	dBm	—	75	—
Output IP3	tone spacing 6 MHz, P_{OUT} per tone = +13 dBm	dBm	—	45	—
P1dB	—	dBm	—	25	—
I_{DD}	$V_{DD} = 5\text{ V}$	mA	—	290	—

Differential RF Amplifier, 75 Ω 5 - 1218 MHz



MAAM-011163

Rev. V7

Typical Performance Curves: 5 - 300 MHz Tune, $V_{DD} = 5\text{ V}$, $+25^\circ\text{C}$

Gain

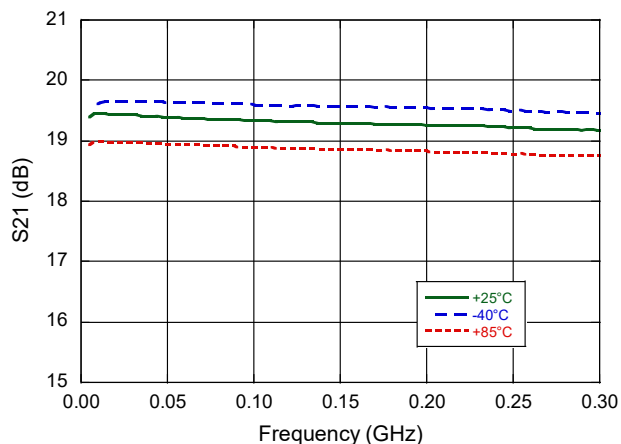

Wideband Gain

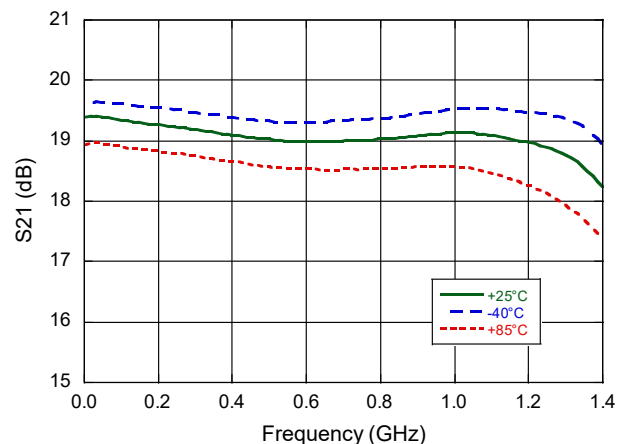

Input Return Loss

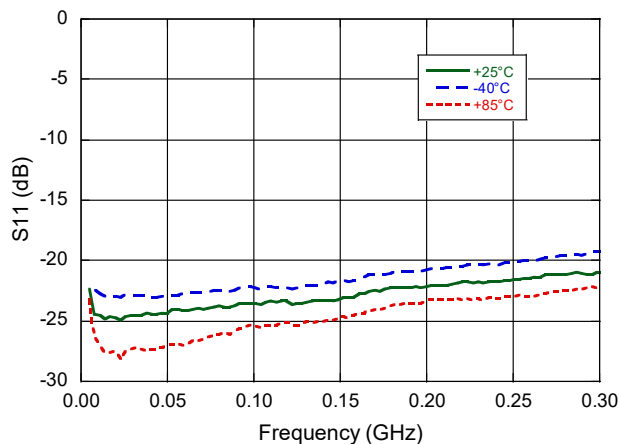

Wideband Input Return Loss

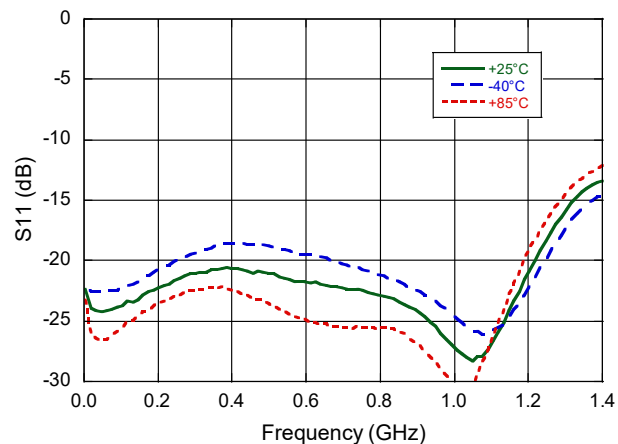

Output Return Loss

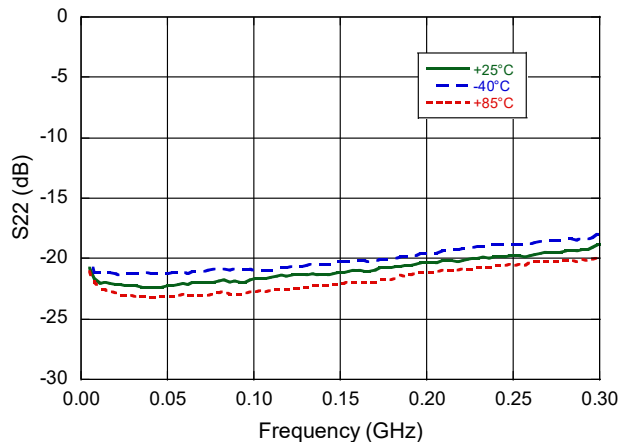

Wideband Output Return Loss

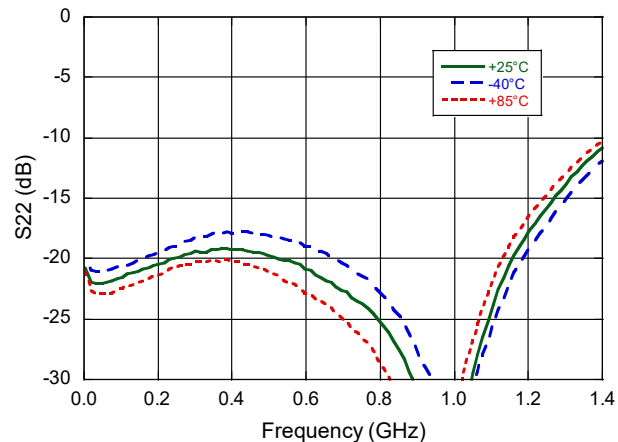

Differential RF Amplifier, 75 Ω 5 - 1218 MHz



MAAM-011163

Rev. V7

Typical Performance Curves: 5 - 300 MHz Tune, $V_{DD} = 5$ V

Noise Figure, 10 - 300 MHz

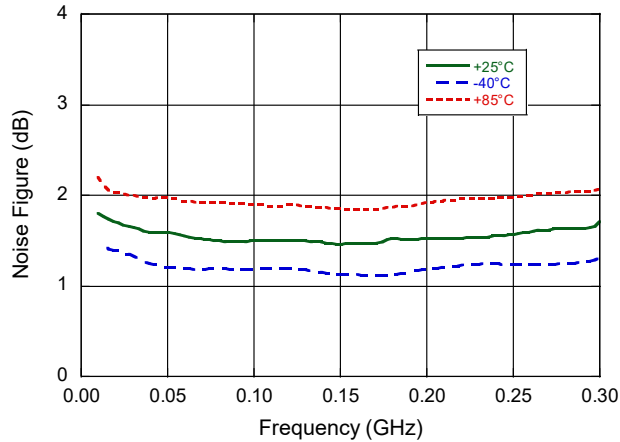

Wideband Noise Figure

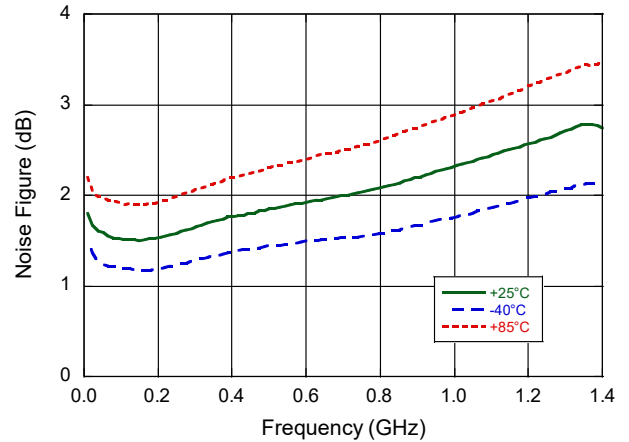

Reverse Isolation

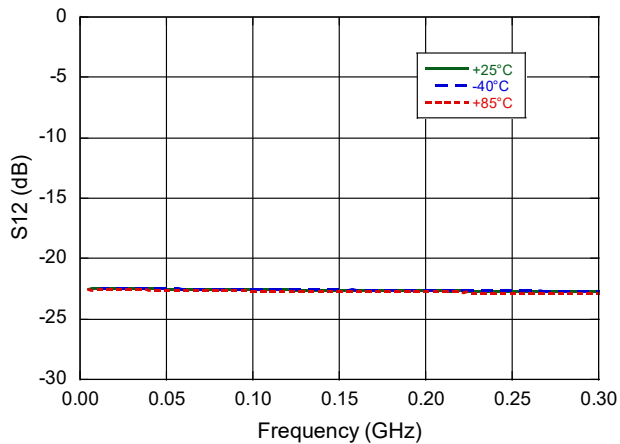

Wideband Reverse Isolation

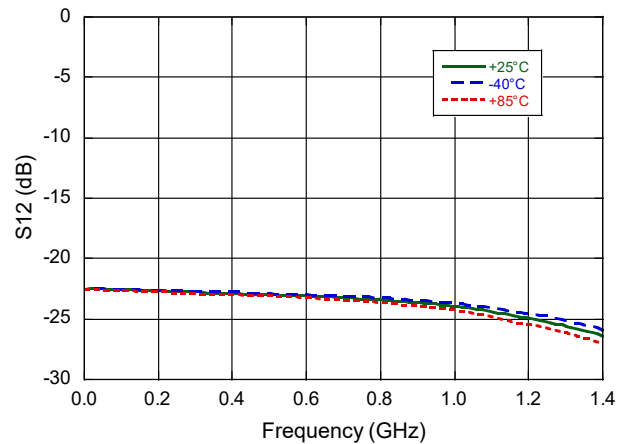

NPR

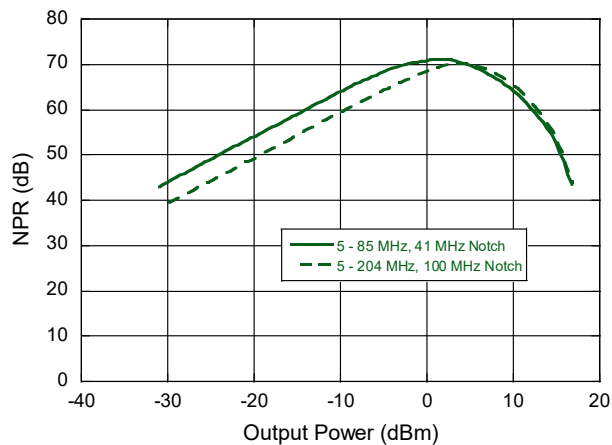

OIP3

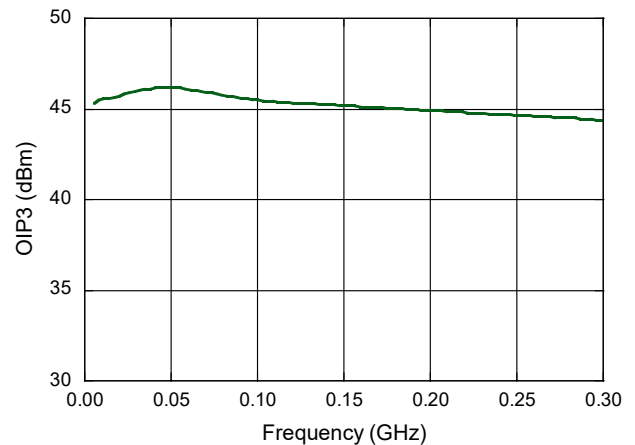

Applications Section: FTTx Application

The MAAM-011163 can be configured as a TIA for optical applications. Operating from 50 - 1200 MHz with a typical gain of 23dB and an output return loss better than 10dB. The MAAM-011163 in this configuration has a typical EIN of 3.5 pA/ $\sqrt{\text{Hz}}$.

Electrical Specifications: 50 - 1200 MHz Tune, $T_A = 25^\circ\text{C}$, $V_{DD} = 5\text{ V}$, $Z_0 = 75\ \Omega$

Parameter	Test Conditions	Units	Min.	Typ.	Max.
Gain	—	dB	—	23	—
Output Return Loss	—	dB	—	12	—
Equivalent Input Noise	—	pA/ $\sqrt{\text{Hz}}$	—	3.5	—
I_{DD}	—	mA	—	265	—

Schematic Including Off-Chip Components

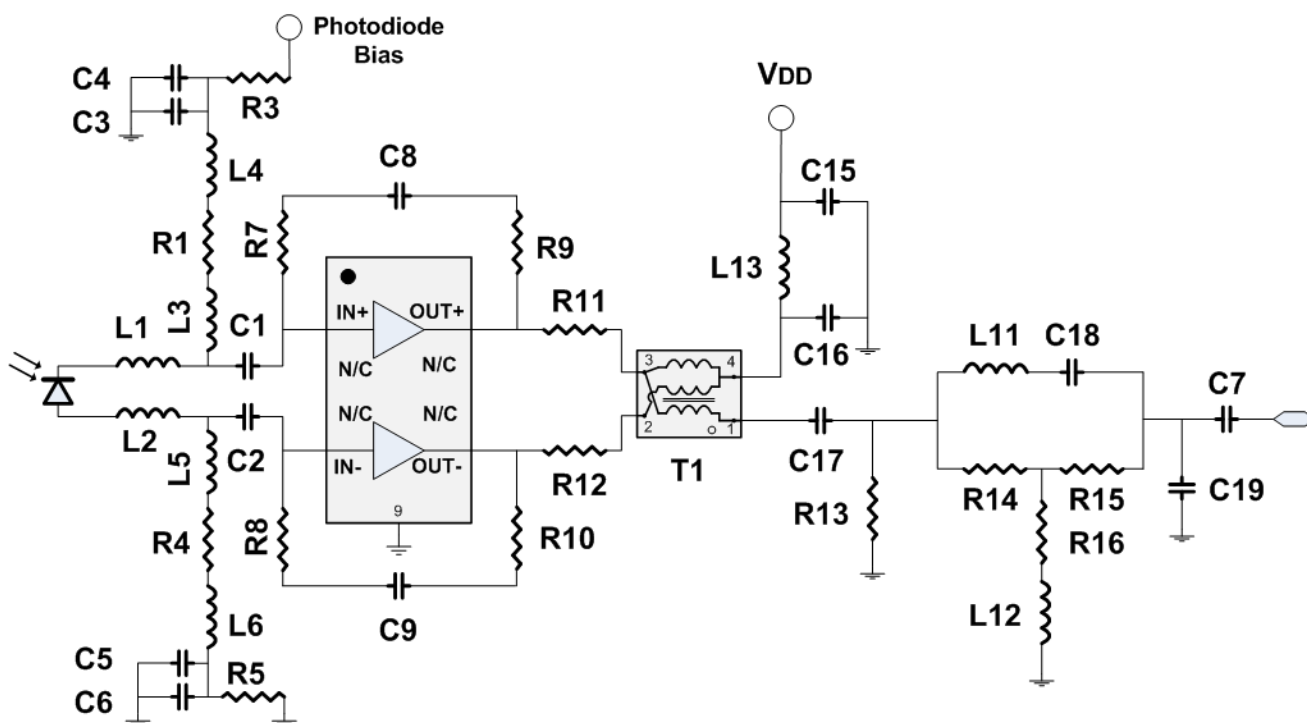

Recommended PCB Layout

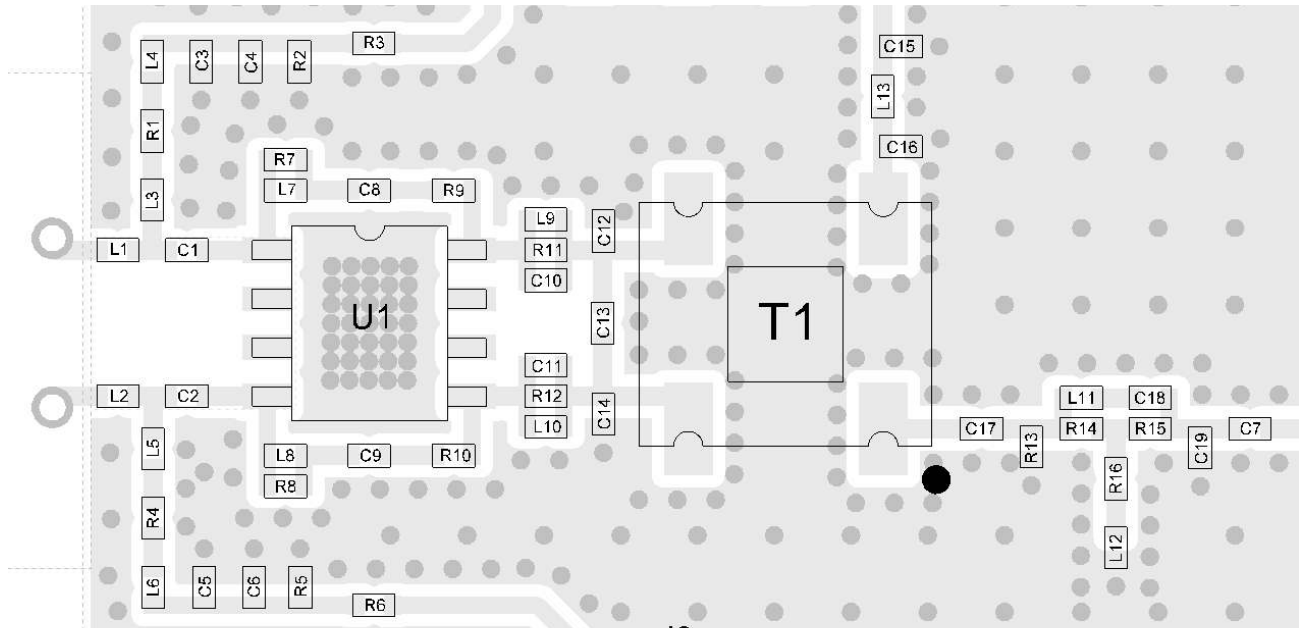

Parts List

Component	Value	Package	Component	Value	Package
C1 - C3, C5, C7 - C9, C16, C17	10 nF	0402	R3	200 Ω	0402
C4, C6, C15	100 nF	0402	R7, R8	2 k Ω	0402
C18	5.6 pF	0402	R9, R10	470 Ω	0402
C19	0.5 pF	0402	R11, R12	0 Ω	0402
L1, L2	3.9 nH	0402	R13	430 Ω	0402
L11	12 nH	0402	R14, R15	39 Ω	0402
L12	68 nH	0402	R16	33 Ω	0402
L3 - L6, L13	BLM15HD182SN1	0402	T1	1:1 Balun ¹⁰	
R1, R4, R5	1 k Ω	0402	J2	10 - Way Header	
L7 - L10, C10 - C14, R2, R6, J3	Do Not Fit				

10. MABA-009210-CT1760

Applications Section: FTTx Application

Typical Performance Curves: $V_{DD} = 5\text{ V}$

Gain

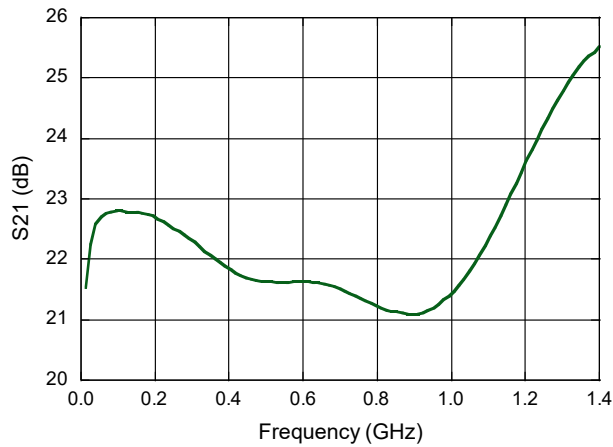

Output Return Loss

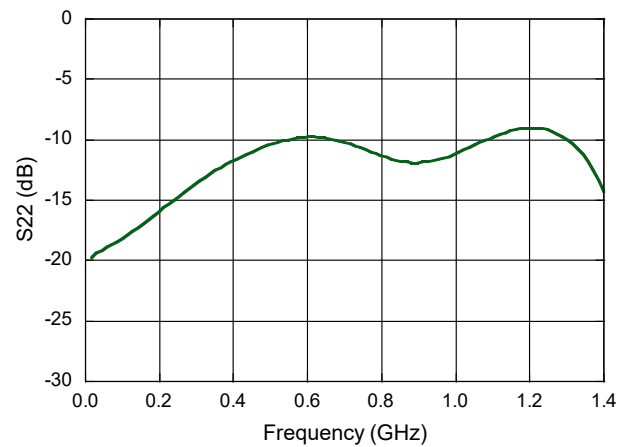

Equivalent Input Noise

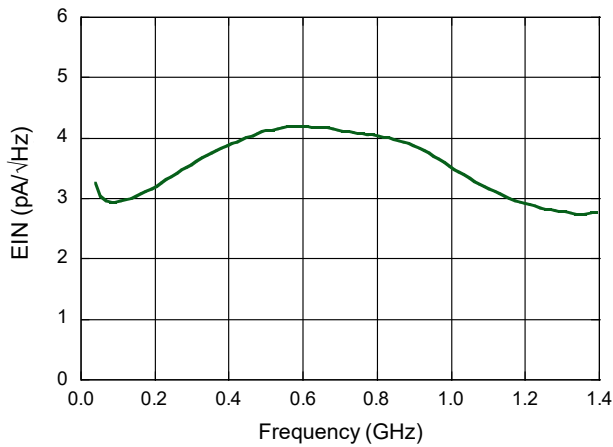

MACOM Technology Solutions Inc. ("MACOM"). All rights reserved.

These materials are provided in connection with MACOM's products as a service to its customers and may be used for informational purposes only. Except as provided in its Terms and Conditions of Sale or any separate agreement, MACOM assumes no liability or responsibility whatsoever, including for (i) errors or omissions in these materials; (ii) failure to update these materials; or (iii) conflicts or incompatibilities arising from future changes to specifications and product descriptions, which MACOM may make at any time, without notice. These materials grant no license, express or implied, to any intellectual property rights.

THESE MATERIALS ARE PROVIDED "AS IS" WITH NO WARRANTY OR LIABILITY, EXPRESS OR IMPLIED, RELATING TO SALE AND/OR USE OF MACOM PRODUCTS INCLUDING FITNESS FOR A PARTICULAR PURPOSE, MERCHANTABILITY, INFRINGEMENT OF INTELLECTUAL PROPERTY RIGHT, ACCURACY OR COMPLETENESS, OR SPECIAL, INDIRECT, INCIDENTAL, OR CONSEQUENTIAL DAMAGES WHICH MAY RESULT FROM USE OF THESE MATERIALS.

MACOM products are not intended for use in medical, lifesaving or life sustaining applications. MACOM customers using or selling MACOM products for use in such applications do so at their own risk and agree to fully indemnify MACOM for any damages resulting from such improper use or sale.