

XUVF120M12

Photoelectric sensors XU, XUV, frame,
200X120mm, 12...24 VDC, M12

Main

Range of Product	Telemecanique Photoelectric sensors XU
Series name	Application material handling
Electronic sensor type	Photo-electric sensor
Sensor name	XUV
Sensor design	Frame
Detection system	Thru beam
Emission	Infrared
Way dimensions of optical frame	200 x 120 mm
Material	Metal
Supply circuit type	DC
Wiring Technique	4-wire
Discrete output type	PNP or NPN
Discrete output function	1 NO or 1 NC programmable
Electrical connection	1 male connector M12, 4 pins
Product Specific Application	Static detection of passage of objects Dynamic detection of passage of objects
Minimum object diameter for detection	Dynamic mode 0.16 in (4 mm) 0.33...49.21 ft/s (0.1...15 m/s) Static mode 0.24 in (6 mm)

Complementary

Enclosure Material	Painted aluminium
Lens material	Altuglass
Type of output signal	Discrete
Output Type	Solid state
Add on output	With alarm output
Status LED	Alarm 1 LED red) Output state 1 LED amber)
[Us] rated supply voltage	24 V DC reverse polarity protection
Supply voltage limits	18...30 V DC
Switching capacity in mA	<= 100 mA overload and short-circuit protection)
Switching frequency	> 5000 Hz
Maximum voltage drop	<2 V closed state)
Current consumption	<= 150 mA no-load
Time delay range	0...5 s off-delay
Maximum delay first up	100 ms
Maximum delay recovery	0.1 ms
Setting-up	Sensitivity adjustment with potentiometer
Depth	0.98 in (25 mm)
Height	9.06 in (230 mm)
Width	8.07 in (205 mm)
Net Weight	2.34 lb(US) (1.06 kg)

The information provided in this documentation contains general descriptions and/or technical characteristics of the performance of the products contained herein. This documentation is not intended as a substitute for and is not to be used for determining suitability or reliability of these products for specific user applications. It is the duty of any such user or integrator to perform the appropriate and complete risk analysis, evaluation and testing of the products with respect to the relevant specific application or use thereof. Neither Schneider Electric Industries SAS nor any of its affiliates or subsidiaries shall be responsible or liable for misuse of the information contained herein.

Environment

Product Certifications	CE cULus
Ambient Air Temperature for Operation	32...140 °F (0...60 °C)
Ambient Air Temperature for Storage	-4...176 °F (-20...80 °C)
Immunity to ambient light	3000 Lux incandescent light 10000 lux sunlight
Vibration resistance	25 gn +/- 2 mm 10...55 Hz) IEC 60068-2-6
Shock resistance	30 gn 11 ms) IEC 60068-2-27
IP degree of protection	IP65 IEC 60529



Ordering and shipping details

Category	22481-SENSORS, PHOTOELECTRIC
Discount Schedule	DS2
GTIN	3389110168877
Nbr. of units in pkg.	1
Package weight(Lbs)	2.55 lb(US) (1.156 kg)
Returnability	No
Country of origin	FR

Packing Units

Unit Type of Package 1	PCE
Package 1 Height	1.34 in (3.4 cm)
Package 1 width	16.85 in (42.8 cm)
Package 1 Length	11.34 in (28.8 cm)
Unit Type of Package 2	S04
Number of Units in Package 2	6
Package 2 Weight	18.43 lb(US) (8.36 kg)
Package 2 Height	11.81 in (30 cm)
Package 2 width	15.75 in (40 cm)
Package 2 Length	23.62 in (60 cm)

Offer Sustainability

California proposition 65	WARNING: This product can expose you to chemicals including: Diisononyl phthalate (DINP), which is known to the State of California to cause cancer, and Di-isodecyl phthalate (DIDP), which is known to the State of California to cause birth defects or other reproductive harm. For more information go to www.P65Warnings.ca.gov
REACH Regulation	 REACH Declaration
EU RoHS Directive	Pro-active compliance (Product out of EU RoHS legal scope)  EU RoHS Declaration
Mercury free	Yes
RoHS exemption information	 Yes

Contractual warranty

Warranty	18 months
----------	-----------

Dimensions

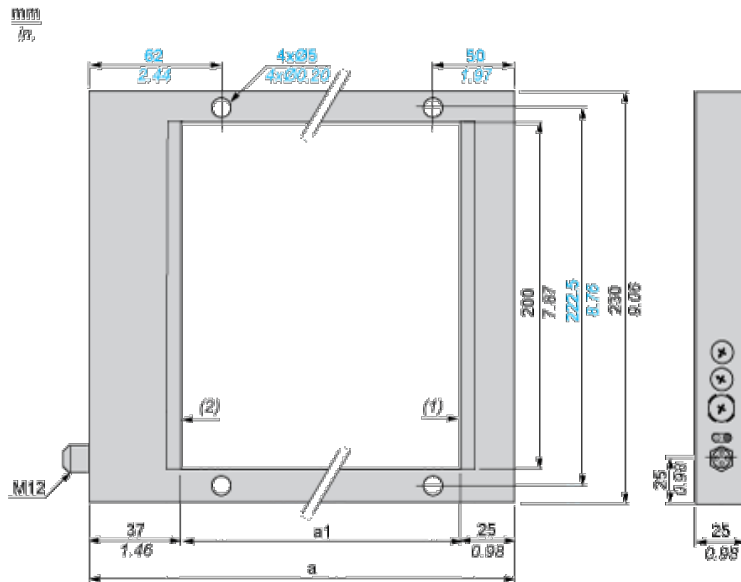

- (1) Transmitting face
- (2) Reception face

Dimensions in mm

a	a1
182	120

Dimensions in in.

a	a1
7.17	4.72

Wiring Schemes (4-Wire DC)

PNP Output

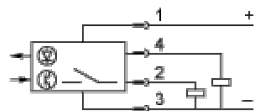

NPN Output

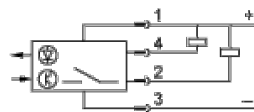

Connector Scheme

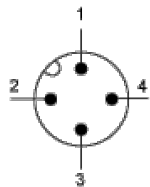

- 1: +
- 2: Not connected
- 3: -
- 4: Output