

PAGE 1/2

ISSUE 22-03-22

SERIE : SPnT

PART NUMBER : R573413310

## RF CHARACTERISTICS

Number of ways : **3**  
 Frequency range : **0 - 18 GHz**  
 Impedance : **50 Ohms**

Frequency (GHz)	DC - 3	3 - 8	8 - 12.4	12.4 - 18
VSWR max	<b>1.20</b>	<b>1.30</b>	<b>1.40</b>	<b>1.50</b>
Insertion loss max	<b>0.20 dB</b>	<b>0.30 dB</b>	<b>0.40 dB</b>	<b>0.50 dB</b>
Isolation min	<b>80 dB</b>	<b>70 dB</b>	<b>60 dB</b>	<b>60 dB</b>
Average power (*)	<b>240 W</b>	<b>150 W</b>	<b>120 W</b>	<b>100 W</b>

## ELECTRICAL CHARACTERISTICS

Actuator : **NORMALLY OPEN**  
 Nominal current \*\* : **102 mA**  
 Actuator voltage (Vcc) : **28V (24 to 30V) / POSITIVE COMMON**  
 Terminals : **solder pins (250°C max. / 30 sec.)**  
 Indicator rating : **1 W / 30 V / 100 mA**

## MECHANICAL CHARACTERISTICS

Connectors : **SMA female per MIL-C 39012**  
 Life : **5 million cycles per position**  
 Switching Time\*\*\* : **< 15 ms**  
 Construction : **Splashproof**  
 Weight : **< 180 g**

## ENVIRONMENTAL CHARACTERISTICS

Operating temperature range : **-40°C to +85°C**  
 Storage temperature range : **-55°C to +85°C**

(\* Average power at 25°C per RF Path)

(\*\* At 25° C ±10%)

(\*\*\* Nominal voltage ; 25° C)



PAGE 2/2

ISSUE 22-03-22

SERIE : SPnT

PART NUMBER : R573413310

DRAWING

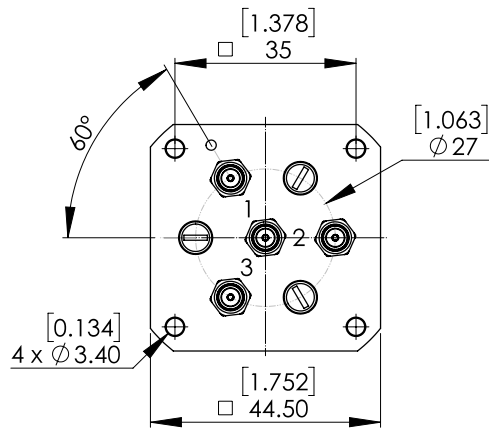

Voltage	RF Continuity	Ind.
+C -1	IN ↔ 1	D,E
+C -2	IN ↔ 2	D,F
+C -3	IN ↔ 3	D,G

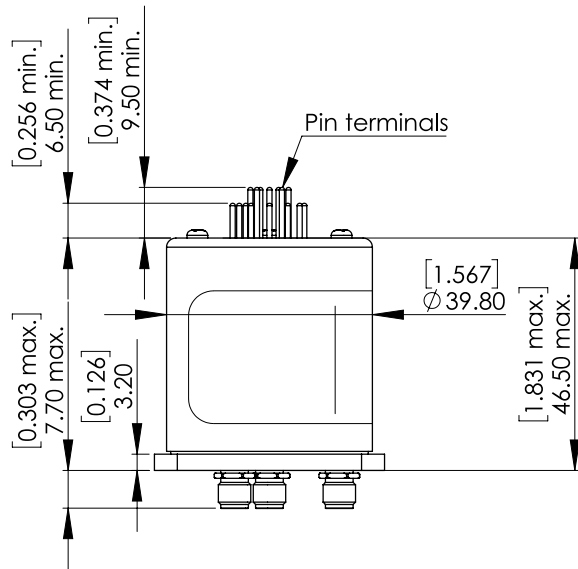

**LABEL**

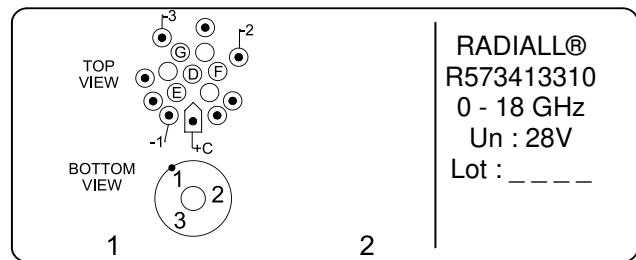

General tolerances : ±0,5 mm [0,02 in]

SCHEMATIC DIAGRAM

