

## General Description

The AOZ1281 is a high efficiency, simple to use, 1.8 A buck regulator flexible enough to be optimized for a variety of applications. The AOZ1281 works from a 3 V to 26 V input voltage range, and provides up to 1.8 A of continuous output current. The output voltage is adjustable down to 0.8 V. The fixed switching frequency of 1.5 MHz PWM operation reduces inductor size.

## Features

- 3 V to 26 V operating input voltage range
- 240 mΩ internal NMOS
- High efficiency: up to 95 %
- Internal compensation
- 1.8 A continuous output current
- Fixed 1.5 MHz PWM operation
- Internal soft start
- Output voltage adjustable down to 0.8 V
- Cycle-by-cycle current limit
- Short-circuit protection
- Thermal shutdown
- Small size: DFN 2x2, 8L

## Applications

- Point of load DC/DC conversion
- Set top boxes
- DVD drives and HDD
- LCD Monitors & TVs
- Cable modems
- Telecom/Networking/Datacom equipment



## Typical Application

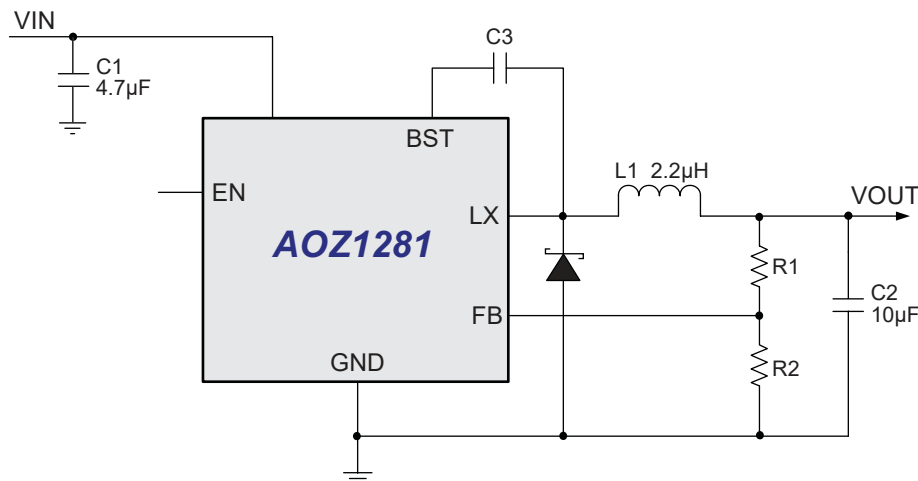

Figure 1. 1.8 A Buck Regulator

## Ordering Information

Part Number	Ambient Temperature Range	Package	Environmental
AOZ1281DI	-40 °C to +85 °C	DFN 2 x 2, 8L	Green Product



AOS Green Products use reduced levels of Halogens, and are also RoHS compliant. Please visit [www.aosmd.com/media/AOSGreenPolicy.pdf](http://www.aosmd.com/media/AOSGreenPolicy.pdf) for additional information.

## Pin Configuration

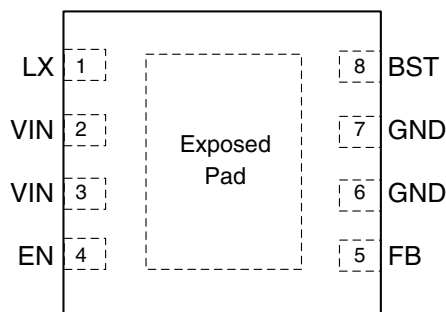

**DFN 2x2, 8L**  
(Top View)

## Pin Description

Pin Number	Pin Name	Pin Function
1	LX	PWM output connection to inductor.
2, 3	VIN	Supply voltage input. Range from 3 V to 26 V. When VIN rises above the UVLO threshold the device starts up. If Vin is lower than 4.5 V, an external 5 V is needed to add through the external diode for BST.
4	EN	Enable pin. The enable pin is active high. Connect EN pin to VIN through current limiting resistor. Do not leave the EN pin floating.
5	FB	Feedback input. It is regulated to 0.8 V. The FB pin is used to determine the PWM output voltage via a resistor divider between the output and GND.
6, 7	GND	Ground.
8	BST	Bootstrap voltage input. High side driver supply. Connected to 10 nF capacitor between BST and LX.
Exposed Pad		Thermal exposed pad. Pad can be connected to GND if necessary for improved thermal performance.

## Absolute Maximum Ratings

Exceeding the Absolute Maximum Ratings may damage the device.

Parameter	Rating
Supply Voltage ( $V_{IN}$ )	30 V
LX to GND	-0.7 V to $V_{IN} + 2$ V
EN to GND	-0.3 V to 26 V
FB to GND	-0.3 V to 6 V
BST to GND	$V_{LX} + 6$ V
Junction Temperature ( $T_J$ )	+150 °C
Storage Temperature ( $T_S$ )	-65 °C to +150 °C
ESD Rating <sup>(1)</sup>	2 kV

**Note:**

1. Devices are inherently ESD sensitive, handling precautions are required. Human body model rating: 1.5 k $\Omega$  in series with 100 pF.

## Recommended Operating Conditions

The device is not guaranteed to operate beyond the Recommended Operating Conditions.

Parameter	Rating
Supply Voltage ( $V_{IN}$ )	3.0 V to 26 V
Output Voltage Range	0.8 V to $0.85 \times V_{IN}$
Ambient Temperature ( $T_A$ )	-40 °C to +85 °C
Package Thermal Resistance DFN 2x2, 8L ( $\Theta_{JA}$ ) <sup>(2)</sup>	55 °C/W

**Note:**

2. The value of  $\Theta_{JA}$  is measured with the device mounted on a 1-in<sup>2</sup> FR-4 board with 2 oz. Copper, in a still air environment with  $T_A = 25$  °C. The value in any given application depends on the user's specific board design.

## Electrical Characteristics

$T_A = 25$  °C,  $V_{IN} = V_{EN} = 12$  V. Specifications in **BOLD** indicate a temperature range of -40 °C to +85 °C. These specifications are guaranteed by design.

Symbol	Parameter	Conditions	Min.	Typ.	Max.	Units
$V_{IN}$	Supply Voltage		<b>3</b>		<b>26</b>	V
$V_{UVLO}$	Input Under-Voltage Lockout Threshold	$V_{IN}$ Rising $V_{IN}$ Falling	2.3		2.9	V V
	UVLO Hysteresis			200		mV
$I_{VIN}$	Supply Current (Quiescent)	$I_{OUT} = 0$ , $V_{FB} = 1$ V, $V_{EN} > 1.2$ V		<b>1</b>	<b>1.5</b>	mA
$I_{OFF}$	Shutdown Supply Current	$V_{EN} = 0$ V			8	$\mu$ A
$V_{FB}$	Feedback Voltage	$T_A = 25$ °C	784	800	816	mV
$V_{FB\_LOAD}$	Load Regulation	120 mA < Load < 1.08 A		0.5		%
$V_{FB\_LINE}$	Line Regulation	Load = 600 mA		0.03		% / V
$I_{FB}$	Feedback Voltage Input Current	$V_{FB} = 800$ mV		500		nA
<b>ENABLE</b>						
$V_{EN\_OFF}$ $V_{EN\_ON}$	EN Input Threshold	Off Threshold On Threshold	<b>1.2</b>		<b>0.4</b>	V V
$V_{EN\_HYS}$	EN Input Hysteresis			200		mV
$I_{EN}$	Enable Input Current				3	$\mu$ A
<b>MODULATOR</b>						
$f_O$	Frequency		1.2	1.5	1.8	MHz
$D_{MAX}$	Maximum Duty Cycle			87		%
$T_{ON\_MIN}$	Minimum On Time			100		ns
$I_{LIM}$	Current Limit		2.2	2.6		A
	Over-Temperature Shutdown Limit	$T_J$ Rising $T_J$ Falling		150 110		°C °C
$T_{SS}$	Soft Start Interval			400		$\mu$ s
<b>POWER STATE OUTPUT</b>						
$R_{DS(ON)}$	NMOS On-Resistance	$V_{IN} = 12$ V		240		m $\Omega$
		$V_{IN} = 3.3$ V		380		m $\Omega$
$I_{LEAKAGE}$	NMOS Leakage	$V_{EN} = 0$ V, $V_{LX} = 0$ V			10	$\mu$ A

Block Diagram

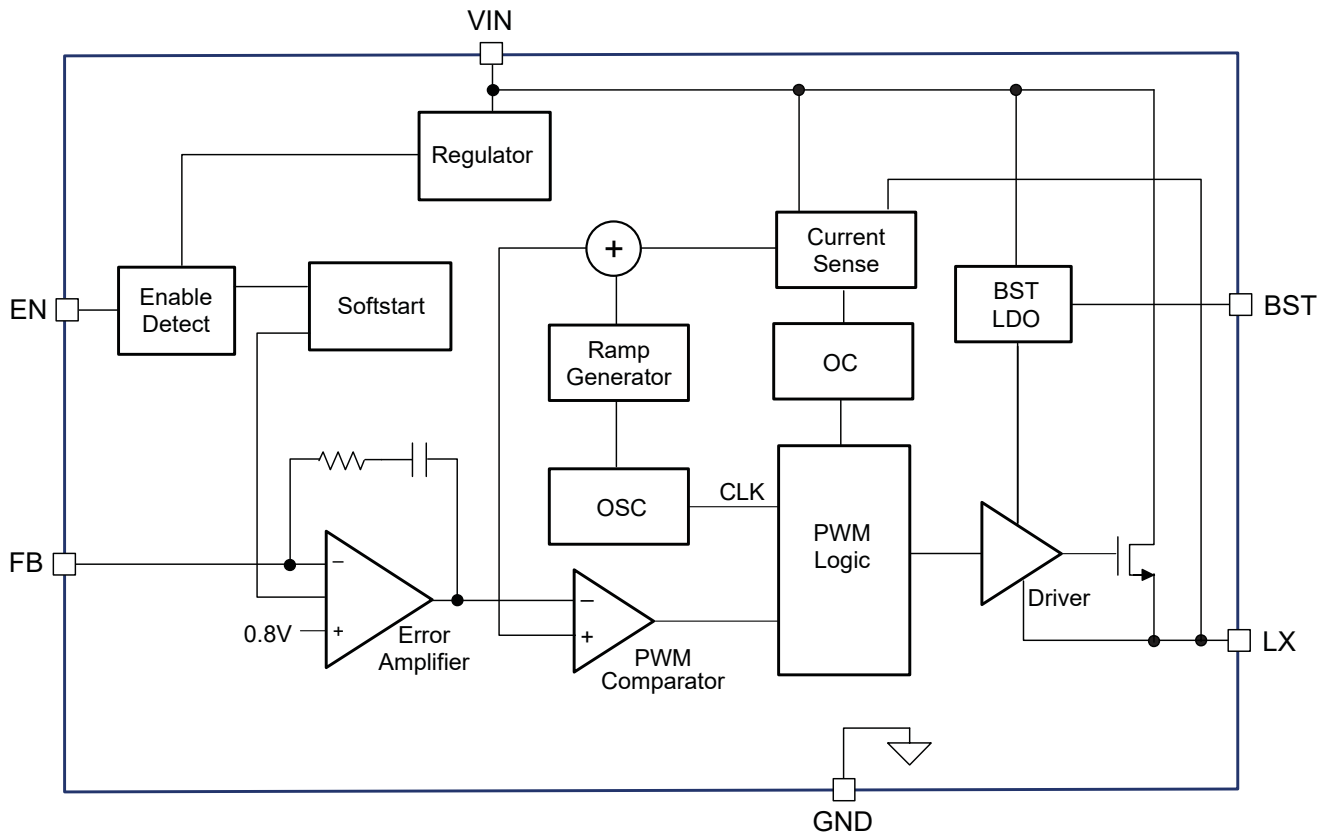

### Typical Performance Characteristics

Circuit of Figure 1.  $V_{IN} = 12\text{ V}$ ,  $V_{OUT} = 3.3\text{ V}$ ,  $L = 4.7\text{ }\mu\text{H}$ ,  $C1 = 10\text{ }\mu\text{F}$ ,  $C2 = 22\text{ }\mu\text{F}$ ,  $T_A = 25\text{ }^\circ\text{C}$ , unless otherwise specified.

**Light Load Operaiton**

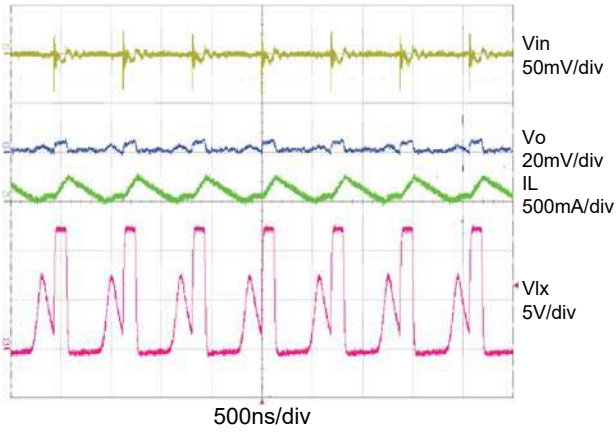

**Full Load Operation**

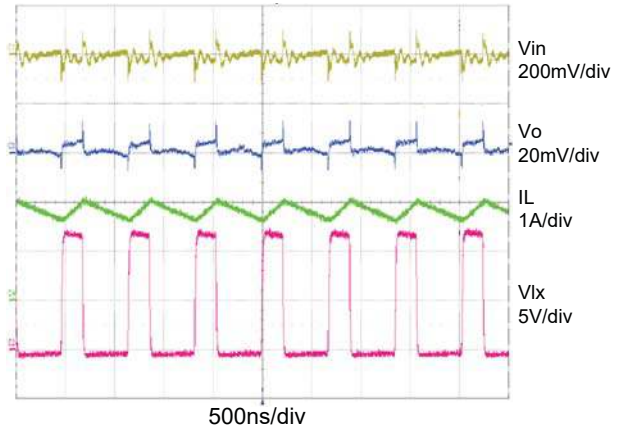

**Startup to Full Load**

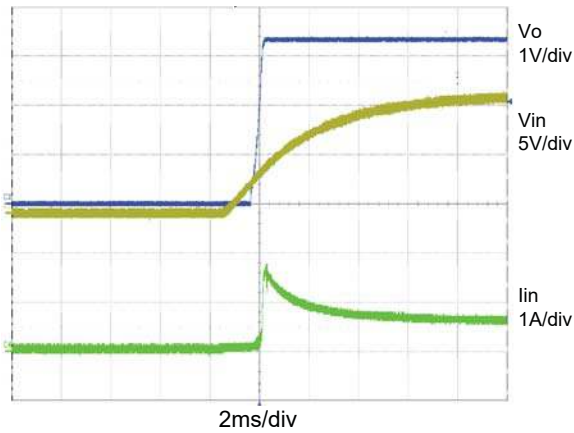

**Short Circuit Protection**

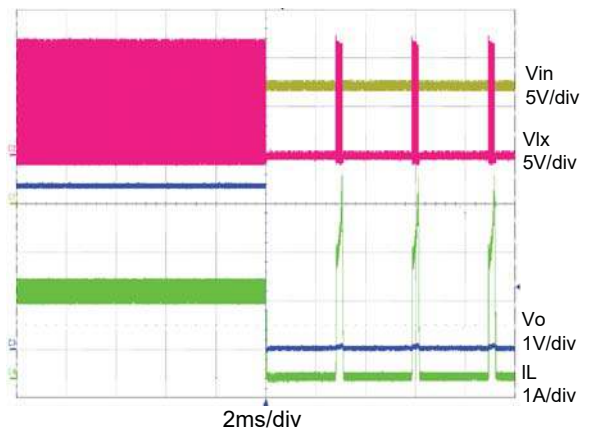

**50% to 100% Load Transient**

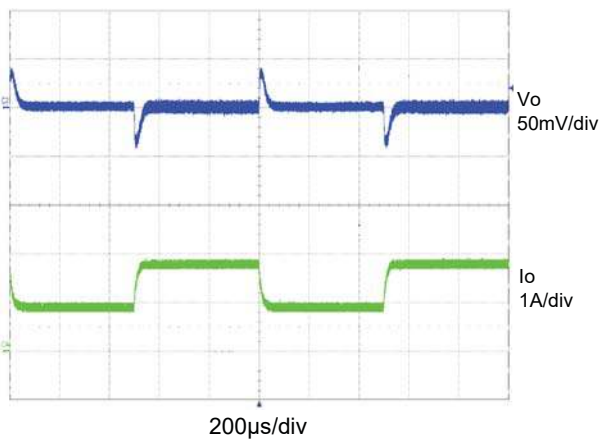

**Short Circuit Recovery**

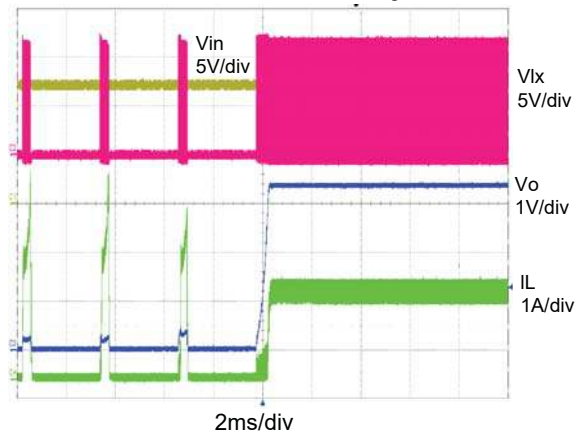

## Efficiency

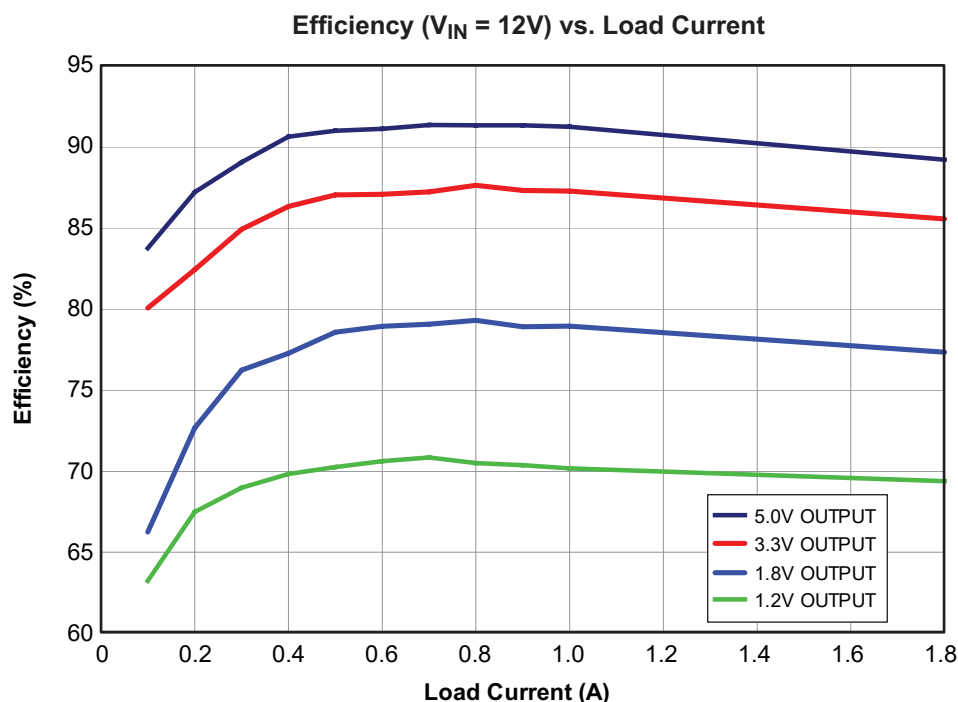

### Detailed Description

The AOZ1281 is a current-mode step down regulator with integrated high side NMOS switch. It operates from a 3 V to 26 V input voltage range and supplies up to 1.8 A of load current. Features include: enable control, under voltage lock-out, internal soft-start, output over-voltage protection, over-current protection, and thermal shut down. The AOZ1281 is available in a DFN 2x2, 8L package.

#### Enable and Soft Start

The AOZ1281 has an internal soft start feature to limit in-rush current and ensure the output voltage ramps up smoothly to regulation voltage. A soft start process begins when the input voltage rises to a voltage higher than UVLO and the voltage level on the EN pin is HIGH. In the soft start process, the output voltage is typically ramped to regulation voltage in 400  $\mu$ s. The 400  $\mu$ s soft start time is set internally.

The EN pin of the AOZ1281 is active high. Connect the EN pin to VIN if the enable function is not used. Pulling EN to ground will disable the AOZ1281. Do not leave EN open. The voltage on the EN pin must be above 1.2 V to enable the AOZ1281. When voltage on the EN pin falls below 0.4 V, the AOZ1281 is disabled.

#### Steady-State Operation

Under steady-state conditions, the converter operates in fixed frequency and Continuous-Conduction Mode (CCM).

The AOZ1281 integrates an internal NMOS as the high-side switch. Inductor current is sensed by amplifying the voltage drop across the drain to the source of the high-side power MOSFET. Output voltage is divided down by the external voltage divider at the FB pin. The difference of the FB pin voltage and reference voltage is amplified by the internal transconductance error amplifier. The error voltage is compared against the current signal, which is sum of inductor current signal plus ramp compensation signal, at the PWM comparator input. If the current signal is less than the error voltage, the internal high-side switch is on. The inductor current flows from the input through the inductor to the output. When the current signal exceeds the error voltage, the high-side switch is off. The inductor current is freewheeling through the external Schottky diode to output.

#### Switching Frequency

The AOZ1281 switching frequency is fixed and set by an internal oscillator. The switching frequency is set internally 1.5 MHz.

### Output Voltage Programming

Output voltage can be set by feeding back the output to the FB pin with a resistor divider network. Refer to the application circuit shown in Figure 1. The resistor divider network includes R<sub>1</sub> and R<sub>2</sub>. Usually, a design is started by picking a fixed R<sub>2</sub> value and calculating the required R<sub>1</sub> with equation below.

$$V_O = 0.8 \times \left( 1 + \frac{R_1}{R_2} \right)$$

Some standard values of R<sub>1</sub> and R<sub>2</sub> for the most commonly used output voltage values are listed in Table 1.

**Table 1.**

V <sub>O</sub> (V)	R <sub>1</sub> (kΩ)	R <sub>2</sub> (kΩ)
1.8	80.6	64.2
2.5	49.9	23.4
3.3	49.9	15.8
5.0	49.9	9.53

The combination of R<sub>1</sub> and R<sub>2</sub> should be large enough to avoid drawing excessive current from the output, which will cause power loss.

### Protection Features

The AOZ1281 has multiple protection features to prevent system circuit damage under abnormal conditions.

#### Over Current Protection (OCP)

The sensed inductor current signal is also used for over current protection.

The cycle-by-cycle current limit threshold is set to 2 A. When the load current reaches the current limit threshold, the cycle-by-cycle current limit circuit immediately turns off the high-side switch to terminate the current duty cycle. The inductor current stop rising. The cycle-by-cycle current limit protection directly limits inductor peak current. The average inductor current is also limited due to the limitation on peak inductor current. When cycle-by-cycle current limit circuit is triggered, the output voltage drops as the duty cycle decreases.

The AOZ1281 has internal short circuit protection to protect itself from catastrophic failure under output short circuit conditions. The FB pin voltage is proportional to the output voltage. Whenever the FB pin voltage is below 0.2 V, the short circuit protection circuit is triggered. As a result, the converter is shut down and hiccups.

The converter will start up via a soft start once the short circuit condition is resolved. In the short circuit protection mode, the inductor average current is greatly reduced.

#### Under Voltage Lock Out (UVLO)

An UVLO circuit monitors the input voltage. When the input voltage exceeds 2.9 V, the converter starts operation. When input voltage falls below 2.3 V, the converter will stop switching.

#### Thermal Protection

An internal temperature sensor monitors the junction temperature. The sensor shuts down the internal control circuit and high side NMOS if the junction temperature exceeds 150 °C. The regulator will restart automatically under the control of the soft-start circuit when the junction temperature decreases to 100 °C.

### Application Information

The basic AOZ1281 application circuit is shown in Figure 1. Component selection is explained below.

#### Input Capacitor

The input capacitor must be connected to the VIN pin and the GND pins of the AOZ1281 to maintain steady input voltage and filter out the pulsing input current. The voltage rating of the input capacitor must be greater than maximum input voltage plus ripple voltage.

The input ripple voltage can be approximated by the equation below:

$$\Delta V_{IN} = \frac{I_O}{f \times C_{IN}} \times \left( 1 - \frac{V_O}{V_{IN}} \right) \times \frac{V_O}{V_{IN}}$$

Since the input current is discontinuous in a buck converter, the current stress on the input capacitor is another concern when selecting the capacitor. For a buck circuit, the RMS value of input capacitor current can be calculated by:

$$I_{CIN\_RMS} = I_O \times \sqrt{\frac{V_O}{V_{IN}} \left( 1 - \frac{V_O}{V_{IN}} \right)}$$

if we let *m* equal the conversion ratio:

$$\frac{V_O}{V_{IN}} = m$$



The relationship between the input capacitor RMS current and voltage conversion ratio is calculated and shown in Figure 2. It can be seen that when  $V_O$  is half of  $V_{IN}$ ,  $C_{IN}$  is under the worst current stress. The worst current stress on  $C_{IN}$  is  $0.5 \times I_O$ .

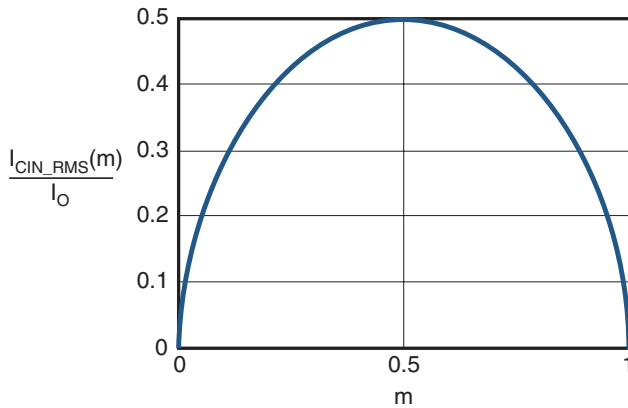

Figure 2.  $I_{CIN}$  vs. Voltage Conversion Ratio

For reliable operation and best performance, the input capacitors must have a current rating higher than  $I_{CIN\_RMS}$  at the worst operating conditions. Ceramic capacitors are preferred for use as input capacitors because of their low ESR and high ripple current rating. Depending on the application circuits, other low ESR tantalum capacitors or aluminum electrolytic capacitors may be used. When selecting ceramic capacitors, X5R or X7R type dielectric ceramic capacitors are preferred for their better temperature and voltage characteristics.

Note that the ripple current rating from capacitor manufacturers is based on a fixed life time. Further de-rating may be necessary for practical design requirements.

### Inductor

The inductor is used to supply constant current to output when it is driven by a switching voltage. For given input and output voltage, inductance and switching frequency together decide the inductor ripple current, which is:

$$\Delta I_L = \frac{V_O}{f \times L} \times \left(1 - \frac{V_O}{V_{IN}}\right)$$

The peak inductor current is:

$$I_{Lpeak} = I_O + \frac{\Delta I_L}{2}$$

High inductance provides a low inductor ripple current but requires larger size inductor to avoid saturation. Low ripple current reduces inductor core losses and also reduces RMS current through inductor and switches. This results in less conduction loss.

When selecting the inductor, confirm it is able to handle the peak current without saturation at the highest operating temperature.

The inductor takes the highest current in a buck circuit. The conduction loss on inductor needs to be checked for thermal and efficiency requirements.

Surface mount inductors in different shape and styles are available from Coilcraft, Elytone and Murata. Shielded inductors are small and radiate less EMI noise but cost more than unshielded inductors. The choice depends on EMI requirement, price and size.

### Output Capacitor

The output capacitor is selected based on the DC output voltage rating, output ripple voltage specification and ripple current rating.

The selected output capacitor must have a higher rated voltage specification than the maximum desired output voltage including ripple. De-rating needs to be considered for long term reliability.

Output ripple voltage specification is another important factor for selecting the output capacitor. In a buck converter circuit, output ripple voltage is determined by inductor value, switching frequency, output capacitor value and ESR. It can be calculated by the equation below:

$$\Delta V_O = \Delta I_L \times \left(ESR_{CO} + \frac{1}{8 \times f \times C_O}\right)$$

where,

$C_O$  is output capacitor value, and

$ESR_{CO}$  is the equivalent series resistance of the output capacitor.

When a low ESR ceramic capacitor is used as the output capacitor, the impedance of the capacitor at the switching frequency dominates. Output ripple is mainly caused by capacitor value and inductor ripple current. The output ripple voltage calculation can be simplified to:

$$\Delta V_O = \Delta I_L \times \left(\frac{1}{8 \times f \times C_O}\right)$$

If the impedance of ESR at switching frequency dominates, the output ripple voltage is mainly decided by capacitor ESR and inductor ripple current. The output ripple voltage calculation can be further simplified to:

$$\Delta V_O = \Delta I_L \times ESR_{CO}$$



For lower output ripple voltage across the entire operating temperature range, X5R or X7R dielectric type of ceramic, or other low ESR tantalum capacitor or aluminum electrolytic capacitor may also be used as output capacitors.

In a buck converter, output capacitor current is continuous. The RMS current of the output capacitor is decided by the peak to peak inductor ripple current. It can be calculated by:

$$I_{CO\_RMS} = \frac{\Delta I_L}{\sqrt{12}}$$

Usually, the ripple current rating of the output capacitor is a smaller issue because of the low current stress. When the buck inductor is selected to be very small and inductor ripple current is high, the output capacitor could be overstressed.

### Schottky Diode Selection

The external freewheeling diode supplies the current to the inductor when the high side NMOS switch is off. To reduce the losses due to the forward voltage drop and recovery of the diode, a Schottky diode is recommended. The maximum reverse voltage rating of the Schottky diode should be greater than the maximum input voltage, and the current rating should be greater than the maximum load current.

### Thermal Management and Layout Consideration

In the AOZ1281 buck regulator circuit, high pulsing current flows through two circuit loops. The first loop starts from the input capacitors, to the VIN pins, to the LX pin, to the filter inductor, to the output capacitor and load, and then returns to the input capacitor through ground. Current flows in the first loop when the high side switch is on. The second loop starts from the inductor, to the output capacitors and load, to the anode of Schottky diode, to the cathode of Schottky diode. Current flows in the second loop when the low side diode is on.

In PCB layout, minimizing the area of the two loops will reduce the noise of this circuit and improves efficiency. A ground plane is strongly recommended to connect the input capacitor, the output capacitor, and the GND pin of the AOZ1281.

In the AOZ1281 buck regulator circuit, the major power dissipating components are the AOZ1281, the Schottky diode and the output inductor. The total power dissipation of the converter circuit can be measured by input power minus output power.

$$P_{total\_loss} = (V_{IN} \times I_{IN}) - (V_O \times I_{OUT})$$

The power dissipation in the Schottky diode can be approximated as:

$$P_{diode\_loss} = I_O \times (1 - D) \times V_{FW\_Schottky}$$

where,

$V_{FW\_Schottky}$  is the Schottky diode forward voltage drop.

The power dissipation of the inductor can be approximately calculated by output current and DCR of the inductor.

$$P_{inductor\_loss} = I_O^2 \times R_{inductor} \times 1.1$$

The actual junction temperature can be calculated with power dissipation in the AOZ1281 and thermal impedance from junction to ambient.

$$T_{junction} = (P_{total\_loss} - P_{diode\_loss} - P_{inductor\_loss}) \times \Theta_{JA} + T_{amb}$$

The maximum junction temperature of AOZ1281 is 150 °C, which limits the maximum load current capability.

The thermal performance of the AOZ1281 is strongly affected by the PCB layout. Extra care should be taken during the design process to ensure that the IC will operate under the recommended environmental conditions.

Several layout tips are listed below for the best electrical and thermal performance.

1. The input capacitor should be connected as close as possible to the VIN pins and the GND pin.
2. The inductor should be placed as close as possible to the LX pin and the output capacitor.
3. Keep the connection of the schottky diode between the LX pin and the GND pin as short and wide as possible.
4. Place the feedback resistors and compensation components as close to the chip as possible.
5. Keep sensitive signal traces away from the LX pin.
6. Pour a maximized copper area to the VIN pins, the LX pin and especially the GND pin to help thermal dissipation.
7. Pour a copper plane on all unused board areas and connect the plane to stable DC nodes, like VIN, GND or VOUT.



### Tape and Reel Dimensions, DFN 2x2, 8L

#### Carrier Tape

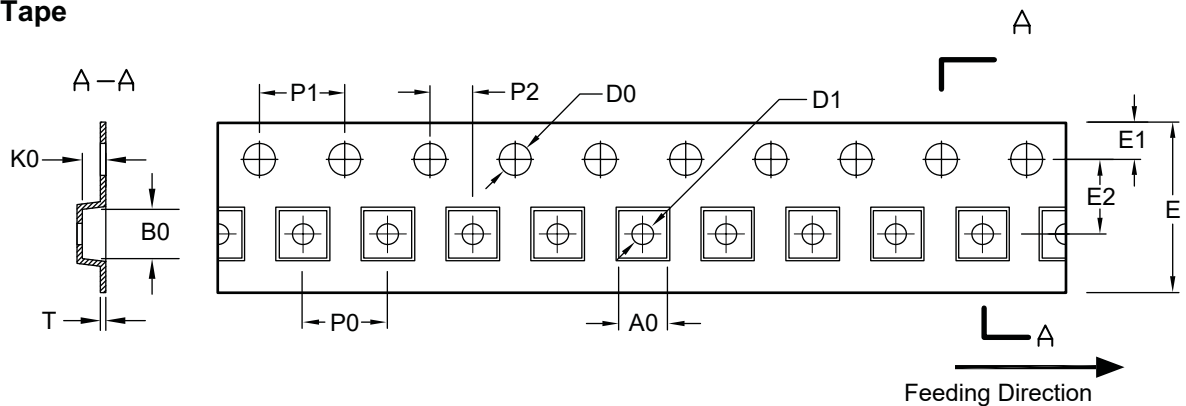

UNIT: mm

Package	A0	B0	K0	D0	D1	E	E1	E2	P0	P1	P2	T
DFN 2x2	2.25 ±0.05	2.25 ±0.05	1.00 ±0.05	1.50 +0.1/-0	1.00 +0.25/-0	8.00 +0.30/-0.10	1.75 ±0.10	3.50 ±0.05	4.00 ±0.10	4.00 ±0.10	2.00 ±0.10	0.254 ±0.02

#### Reel

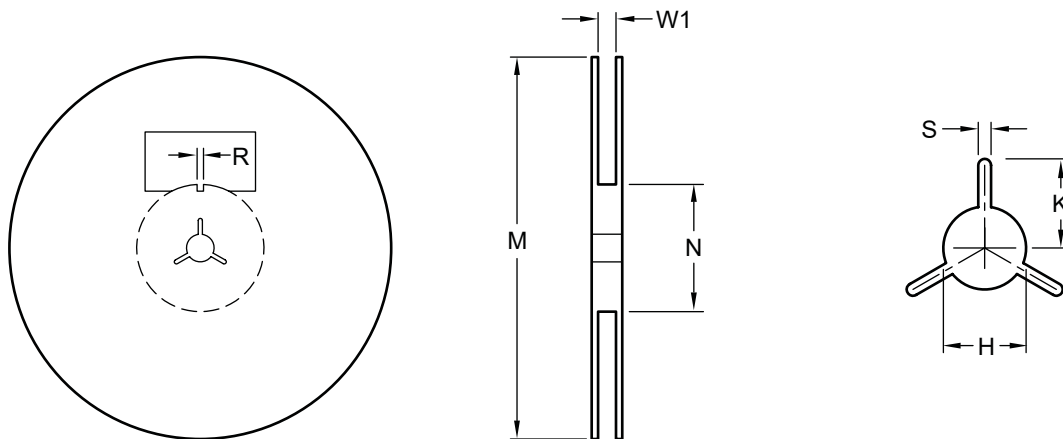

UNIT: mm

Tape Size	Reel Size	M	N	W1	H	S	K	R
8mm	ø180	ø180.00 ±0.50	60.0 ±0.50	8.4 +1.5/-0.0	13.0 ±0.20	1.5 Min.	13.5 Min.	3.0 ±0.50

#### Leader / Trailer & Orientation

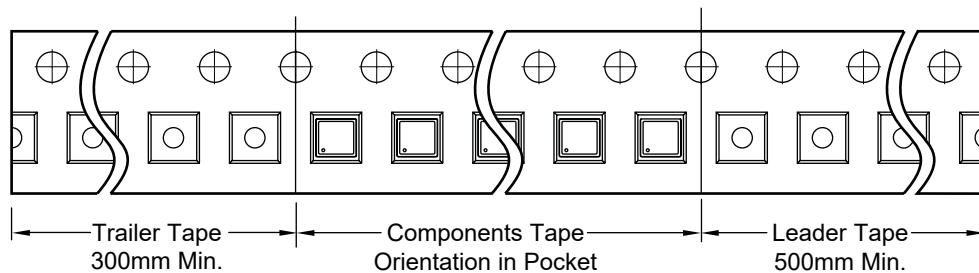

**Part Marking**

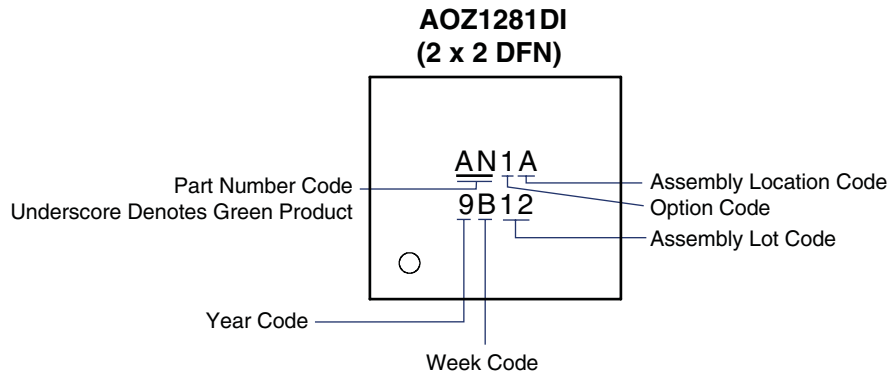

**LEGAL DISCLAIMER**

Applications or uses as critical components in life support devices or systems are not authorized. AOS does not assume any liability arising out of such applications or uses of its products. AOS reserves the right to make changes to product specifications without notice. It is the responsibility of the customer to evaluate suitability of the product for their intended application. Customer shall comply with applicable legal requirements, including all applicable export control rules, regulations and limitations.

AOS' products are provided subject to AOS' terms and conditions of sale which are set forth at:

[http://www.aosmd.com/terms\\_and\\_conditions\\_of\\_sale](http://www.aosmd.com/terms_and_conditions_of_sale)

**LIFE SUPPORT POLICY**

ALPHA & OMEGA SEMICONDUCTOR PRODUCTS ARE NOT AUTHORIZED FOR USE AS CRITICAL COMPONENTS IN LIFE SUPPORT DEVICES OR SYSTEMS.

As used herein:

- |   |   |
|---|---|
| <p>1. Life support devices or systems are devices or systems which, (a) are intended for surgical implant into the body or (b) support or sustain life, and (c) whose failure to perform when properly used in accordance with instructions for use provided in the labeling, can be reasonably expected to result in a significant injury of the user.</p> | <p>2. A critical component in any component of a life support, device, or system whose failure to perform can be reasonably expected to cause the failure of the life support device or system, or to affect its safety or effectiveness.</p> |
|---|---|