

DATA SHEET

PD4W18-59LF: 1.71-1.99 GHz Four-Way 0° Power Splitter/Combiner

Applications

- Cellular radios
- Transmitters/receivers

Features

- Low loss
- High isolation
- Good I/O match
- Excellent phase/amplitude balance
- Low profile MSOP-8 (8-pin, 3 x 3 mm) package (MSL1, 260 °C per JEDEC J-STD-020)



Skyworks Green™ products are compliant with all applicable legislation and are halogen-free. For additional information, refer to *Skyworks Definition of Green™*, document number SQ04-0074.

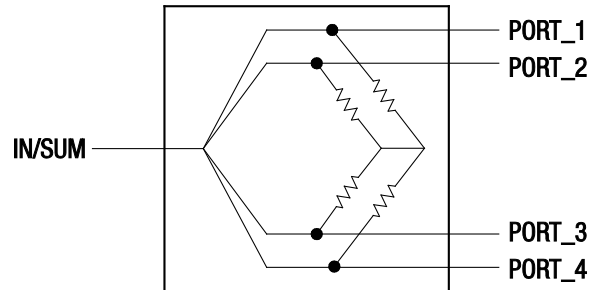

S2479

Figure 1. PD4W18-59LF Block Diagram

Description

The PD4W18-59LF is a monolithic, four-way in-phase hybrid junction tuned for the 1.71 GHz to 1.99 GHz band. The device offers low loss, high isolation, good input/output matching and exceptional phase/amplitude balance.

A functional block diagram is shown in Figure 1. The pin configuration and package are shown in Figure 2. Signal pin assignments and functional pin descriptions are provided in Table 1.

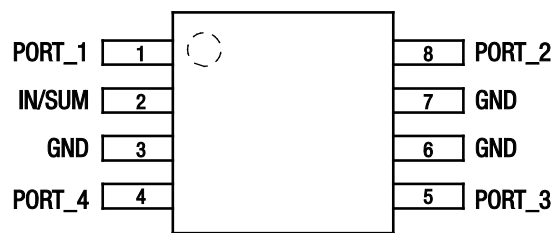

S2483

Figure 2. PD4W18-59LF Pinout – 8-Pin MSOP-8 (Top View)

Table 1. PD4W18-59LF Signal Descriptions

Pin #	Name	Description	Pin #	Name	Description
1	PORT_1	RF port 1	5	PORT_3	RF port 3
2	IN/SUM	Common input or summing RF port	6	GND	Ground
3	GND	Ground	7	GND	Ground
4	PORT_4	RF port 4	8	PORT_2	RF port 2

Table 2. PD4W18-59LF Absolute Maximum Ratings (Note 1)

Parameter	Symbol	Minimum	Maximum	Units
Input power, CW	P _{IN}		1.500 (Note 2)	W
			0.375 (Note 3)	W
Storage temperature	T _{STG}	-60	+150	°C
Operating temperature	T _{OP}	-40	+85	°C

Note 1: Exposure to maximum rating conditions for extended periods may reduce device reliability. There is no damage to device with only one parameter set at the limit and all other parameters set at or below their nominal value. Exceeding any of the limits listed here may result in permanent damage to the device.

Note 2: When used as a power divider with a 2.0:1 maximum VSWR on all ports.

Note 3: When used as a power combiner with a 2.0:1 maximum VSWR on all ports.

CAUTION: Although this device is designed to be as robust as possible, Electrostatic Discharge (ESD) can damage this device. This device must be protected at all times from ESD. Static charges may easily produce potentials of several kilovolts on the human body or equipment, which can discharge without detection. Industry-standard ESD precautions should be used at all times.

Table 3. PD4W18-59LF Series Electrical Specifications (Note 1)
(T_{OP} = +25 °C, Characteristic Impedance [Z₀] = 50 Ω, Unless Otherwise Noted)

Parameter	Symbol	Test Condition	Min	Typical	Max	Units
Frequency range	f		1.71		1.99	GHz
Insertion loss	IL	In excess of a 6 dB split loss		0.7	1.2	dB
Isolation	Iso		20	25		dB
Input VSWR	VSWR	IN/SUM port		1.3:1	1.6:1	-
Output VSWR	VSWR	PORT_1, PORT_2, PORT_3, PORT_4		1.3:1	1.6:1	-
Amplitude balance				±0.3	±0.4	dB
Phase balance				±5	±8	deg

Note 1: Performance is guaranteed only under the conditions listed in this Table.

Electrical and Mechanical Specifications

The absolute maximum ratings of the PD4W18-59LF are provided in Table 2. Electrical specifications are provided in Table 3.

Typical performance characteristics are shown in Figures 3 through 8.

Typical Performance Characteristics

(TOP = +25 °C, Characteristic Impedance [Z₀] = 50 Ω, P_{IN} = 0 dBm, Unless Otherwise Noted)

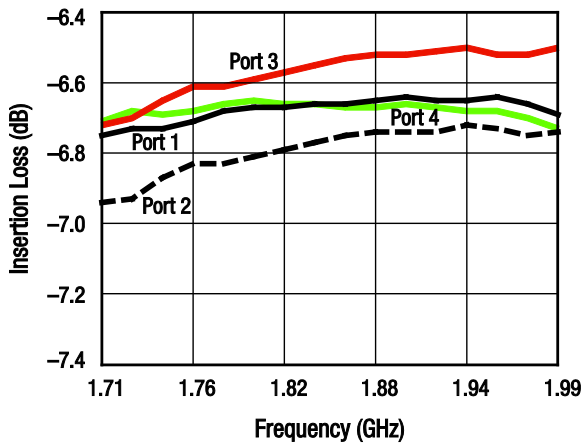

Figure 3. Insertion Loss vs Frequency

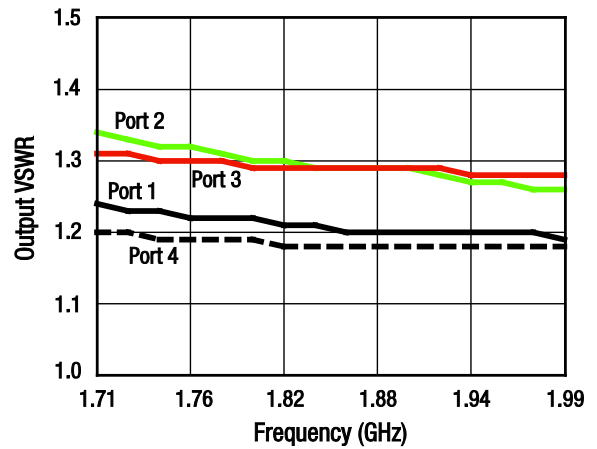

Figure 4. Output VSWR vs Frequency

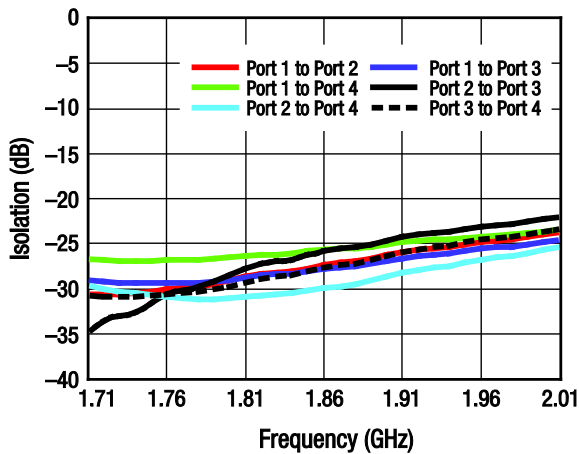

Figure 5. Isolation vs Frequency

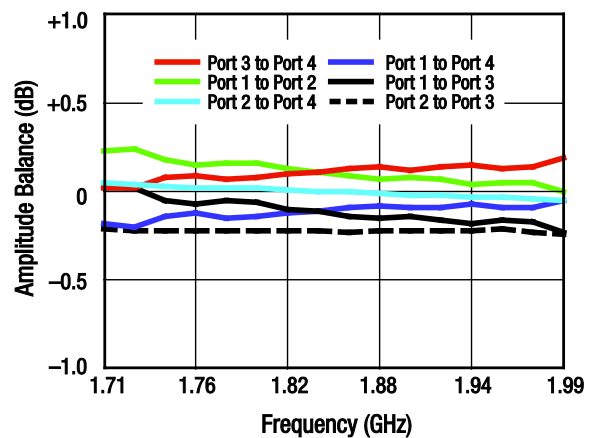

Figure 6. Amplitude Balance vs Frequency

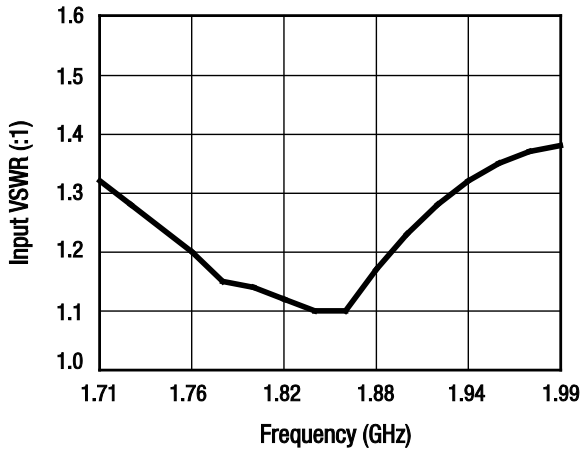

Figure 7. Input VSWR vs Frequency

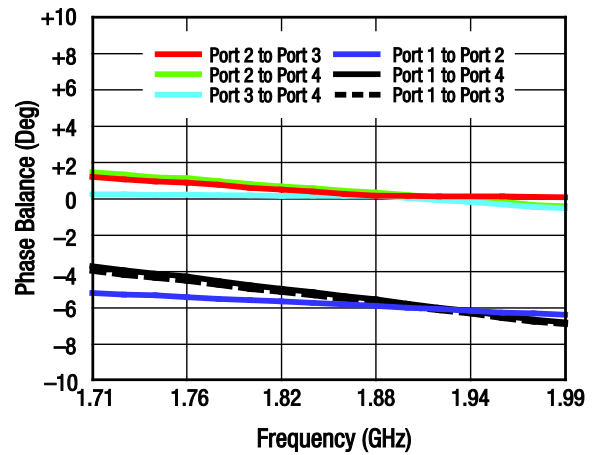

Figure 8. Phase Balance vs Frequency

Evaluation Board Description

The PD4W18-59LF Evaluation Board is used to test the performance of the PD4W18-59LF power splitter/combiner. An assembly drawing for the Evaluation Board is shown in Figure 9 and the layer detail is provided in Figure 10.

Package Dimensions

The PCB layout footprint for the PD4W18-59LF is provided in Figure 11. Typical case markings are shown in Figure 12. Package dimensions for the 8-pin MSOP-8 are shown in Figure 13, and tape and reel dimensions are provided in Figure 14.

Package and Handling Information

Instructions on the shipping container label regarding exposure to moisture after the container seal is broken must be followed. Otherwise, problems related to moisture absorption may occur when the part is subjected to high temperature during solder assembly.

The PD4W18-59LF is rated to Moisture Sensitivity Level 1 (MSL1) at 260 °C. It can be used for lead or lead-free soldering. For additional information, refer to the Skyworks Application Note, *Solder Reflow Information*, document number 200164.

Care must be taken when attaching this product, whether it is done manually or in a production solder reflow environment. Production quantities of this product are shipped in a standard tape and reel format.

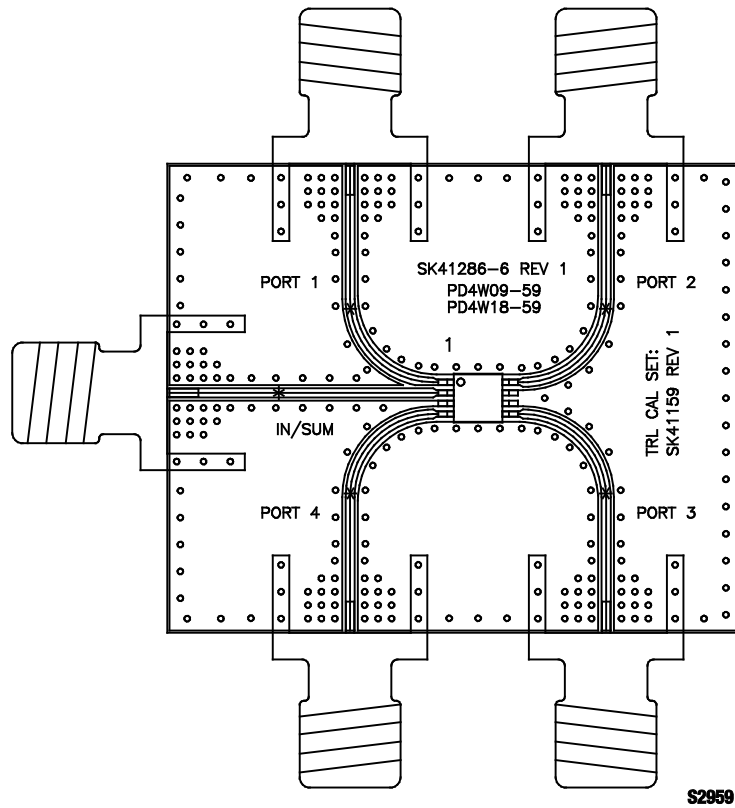

Figure 9. PD4W18-59LF Evaluation Board Assembly Drawing

Cross Section	Name	Thickness (in)	Material
	Top Soldermask		
	L1	(0.0028)	Cu foil
	Laminate	0.012 ± 0.0006	Rogers RO4003C Core
	L2	(0.0014)	Cu foil
	Laminate	(Note 1)	FR4 Prepreg
	L3	(0.0014)	Cu foil
	Laminate	0.010 ± 0.0006	FR4 Core
	L4	(0.0028)	Cu foil
	Bottom Soldermask		

Note 1: Adjust this thickness to meet total thickness goal of 0.062 ± 0.005 inches.

S2831

Figure 10. PD4W18-59LF Evaluation Board Layer Detail

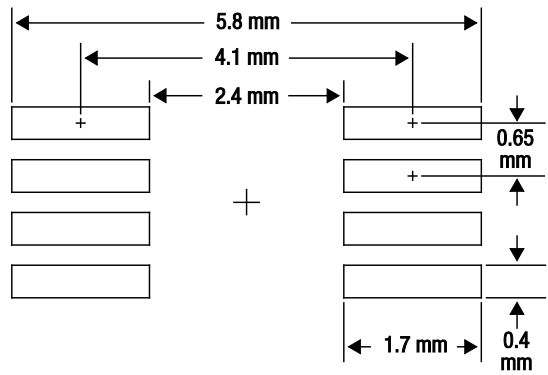

S2280

Figure 11. PD4W18-59LF PCB Layout Footprint

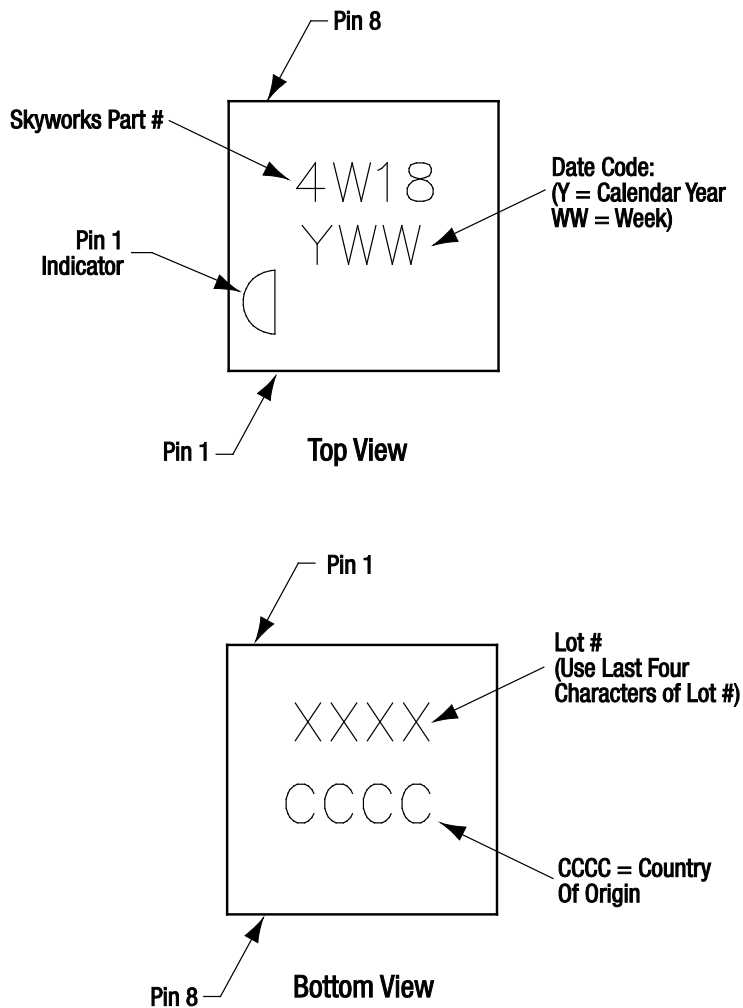
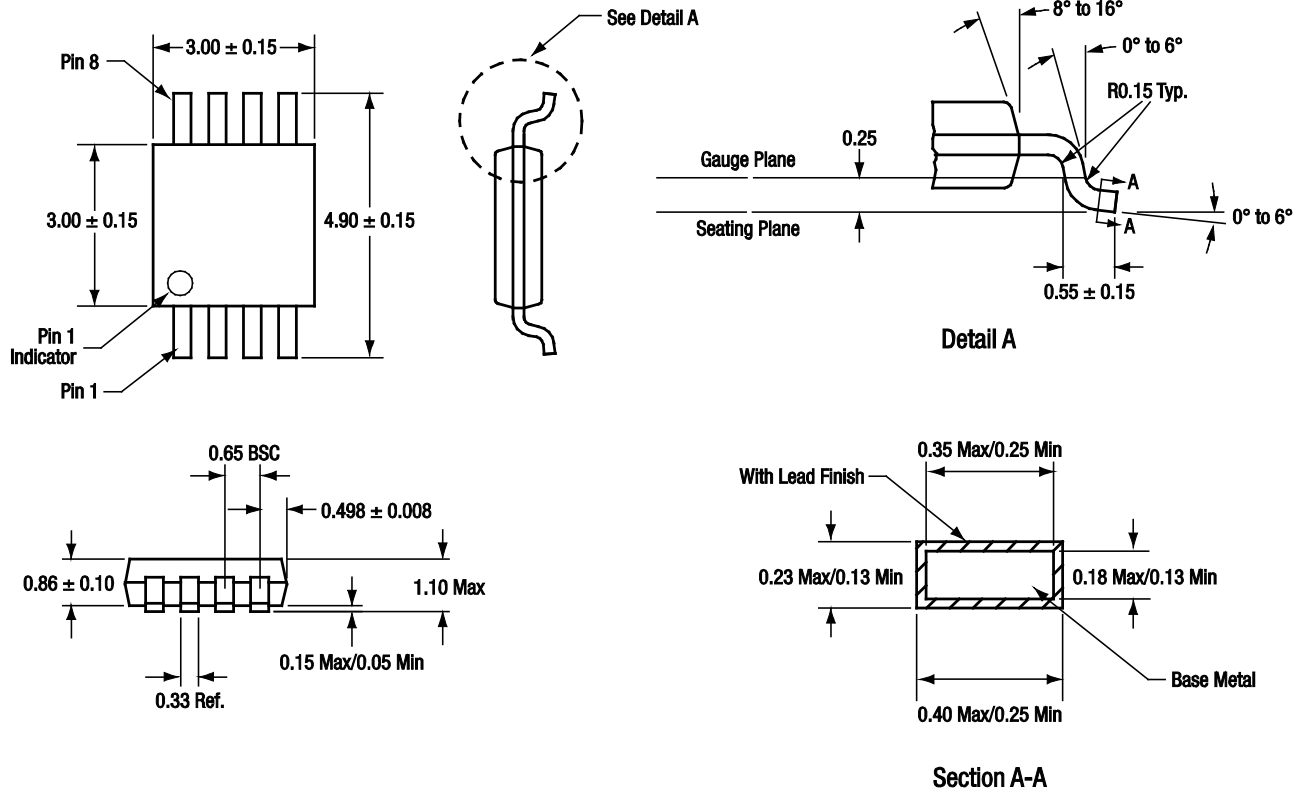

Figure 12. Typical Part Markings (Top View)



All measurements are in millimeters.
 Dimensioning and tolerancing according to ASME Y14.5M-1994.
 Body length dimension does not include mold protrusions and gate burrs do not exceed 0.15 mm per end. Body width dimension does not include interlead mold protrusions. Interlead mold protrusions do not exceed 0.15 mm per side.
 Lead width dimension does not include dambar protrusion/intrusion. Allowable dambar protrusion is 0.07 mm total in excess of lead width dimension at maximum material condition.
 Details of pin 1 identifier are optional.
 JEDEC standard practices and procedures apply (JEDEC Standard No. 95-1, Section 3).
 Lead coplanarity is 0.10 mm maximum.

S2482

Figure 13. PD4W18-59LF 8-Pin MSOP-8 Package Dimensions

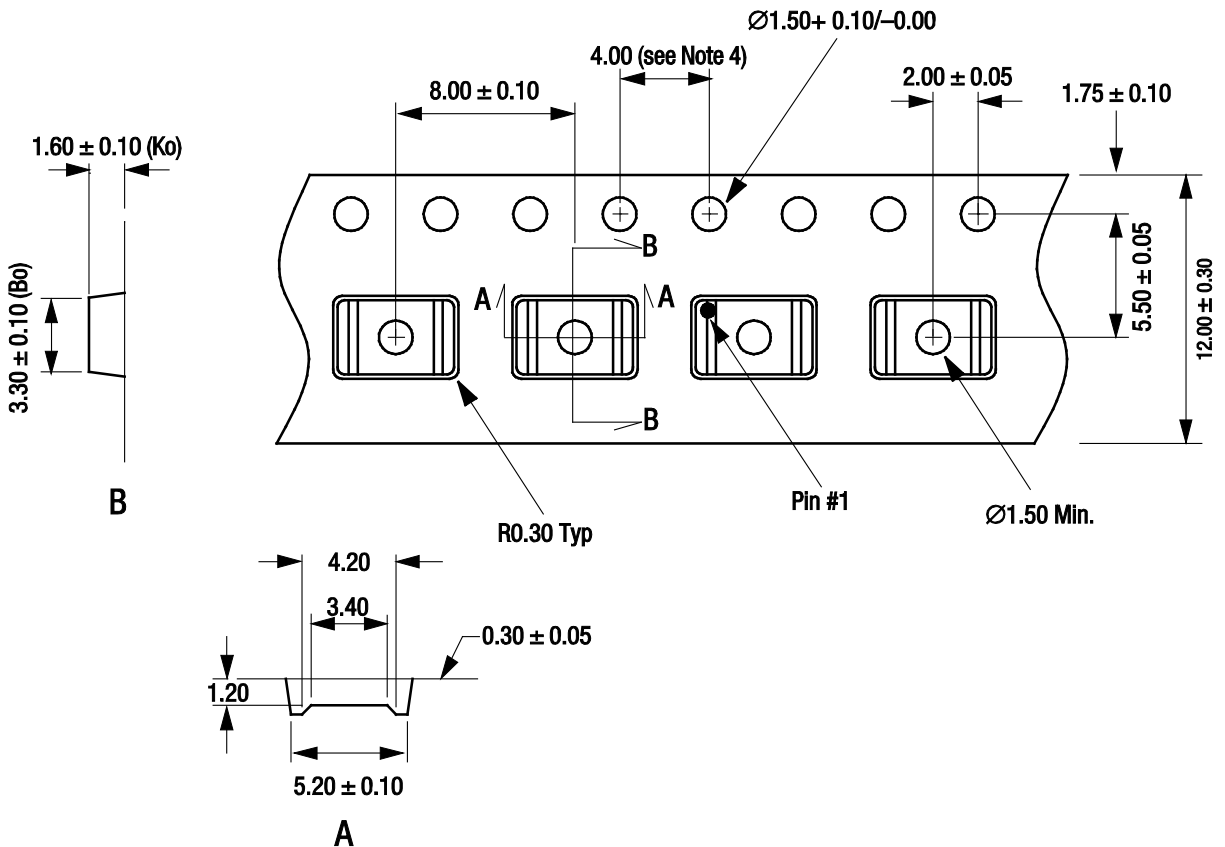

- Notes:
1. Carrier tape: black conductive polystyrene.
 2. Cover tape material: transparent conductive HSA.
 3. Cover tape size: 9.2 mm width.
 4. Ten sprocket hole pitch cumulative tolerance = ± 0.20 mm.
 5. All measurements are in millimeters.
 6. Standard reel size is 7 inches. Standard reel quantity is 3000 pcs.

S2348

Figure 14. MSOP-8 Tape and Reel Dimensions

Ordering Information

Model Name	Manufacturing Part Number	Evaluation Board Part Number
PD4W18-59LF Four-Way Power Splitter/Combiner	PD4W18-59LF	PD4W18-59LF-EVB

Copyright © 2002-2006, 2012 Skyworks Solutions, Inc. All Rights Reserved.

Information in this document is provided in connection with Skyworks Solutions, Inc. ("Skyworks") products or services. These materials, including the information contained herein, are provided by Skyworks as a service to its customers and may be used for informational purposes only by the customer. Skyworks assumes no responsibility for errors or omissions in these materials or the information contained herein. Skyworks may change its documentation, products, services, specifications or product descriptions at any time, without notice. Skyworks makes no commitment to update the materials or information and shall have no responsibility whatsoever for conflicts, incompatibilities, or other difficulties arising from any future changes.

No license, whether express, implied, by estoppel or otherwise, is granted to any intellectual property rights by this document. Skyworks assumes no liability for any materials, products or information provided hereunder, including the sale, distribution, reproduction or use of Skyworks products, information or materials, except as may be provided in Skyworks Terms and Conditions of Sale.

THE MATERIALS, PRODUCTS AND INFORMATION ARE PROVIDED "AS IS" WITHOUT WARRANTY OF ANY KIND, WHETHER EXPRESS, IMPLIED, STATUTORY, OR OTHERWISE, INCLUDING FITNESS FOR A PARTICULAR PURPOSE OR USE, MERCHANTABILITY, PERFORMANCE, QUALITY OR NON-INFRINGEMENT OF ANY INTELLECTUAL PROPERTY RIGHT; ALL SUCH WARRANTIES ARE HEREBY EXPRESSLY DISCLAIMED. SKYWORKS DOES NOT WARRANT THE ACCURACY OR COMPLETENESS OF THE INFORMATION, TEXT, GRAPHICS OR OTHER ITEMS CONTAINED WITHIN THESE MATERIALS. SKYWORKS SHALL NOT BE LIABLE FOR ANY DAMAGES, INCLUDING BUT NOT LIMITED TO ANY SPECIAL, INDIRECT, INCIDENTAL, STATUTORY, OR CONSEQUENTIAL DAMAGES, INCLUDING WITHOUT LIMITATION, LOST REVENUES OR LOST PROFITS THAT MAY RESULT FROM THE USE OF THE MATERIALS OR INFORMATION, WHETHER OR NOT THE RECIPIENT OF MATERIALS HAS BEEN ADVISED OF THE POSSIBILITY OF SUCH DAMAGE.

Skyworks products are not intended for use in medical, lifesaving or life-sustaining applications, or other equipment in which the failure of the Skyworks products could lead to personal injury, death, physical or environmental damage. Skyworks customers using or selling Skyworks products for use in such applications do so at their own risk and agree to fully indemnify Skyworks for any damages resulting from such improper use or sale.

Customers are responsible for their products and applications using Skyworks products, which may deviate from published specifications as a result of design defects, errors, or operation of products outside of published parameters or design specifications. Customers should include design and operating safeguards to minimize these and other risks. Skyworks assumes no liability for applications assistance, customer product design, or damage to any equipment resulting from the use of Skyworks products outside of stated published specifications or parameters.

Skyworks, the Skyworks symbol, and "Breakthrough Simplicity" are trademarks or registered trademarks of Skyworks Solutions, Inc., in the United States and other countries. Third-party brands and names are for identification purposes only, and are the property of their respective owners. Additional information, including relevant terms and conditions, posted at www.skyworksinc.com, are incorporated by reference.