

APPROVED: _____

DATE: _____ TITLE: _____

Rev	AWO #	Description	Date	Appr
-		RELEASED	11/11/20	
A		UPDATE SPEC.	8/10/21	WX/RC
B		UPDATE SPEC.	10/20/21	WX/RC
C		UPDATED DRAWING	6/17/22	JJ/MC
D		UPDATED SPEC.	2/9/23	WX/RZ

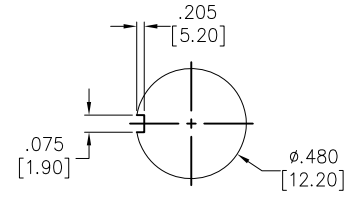
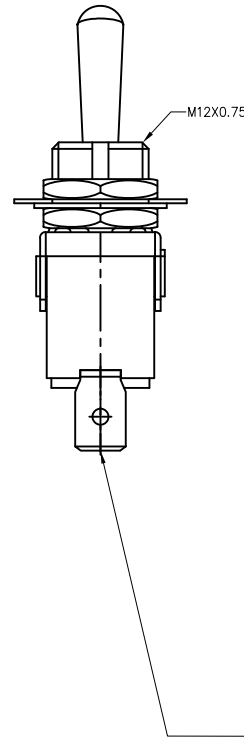
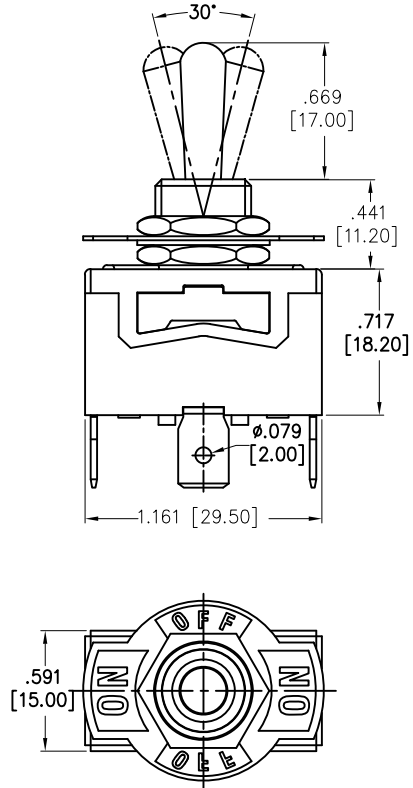

RECOMMENDED
PANEL CUT-OUT

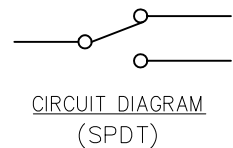

CIRCUIT DIAGRAM
(SPDT)

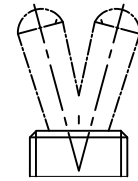

2 WAY

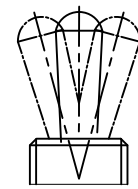

3 WAY

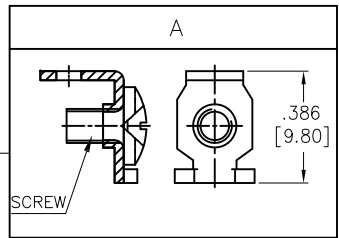

- SW-T1-2X-D-K1
- B=ON-ON
 - D=ON-(ON)
 - E=ON-OFF-ON
 - F=ON-OFF-(ON)
 - G=(ON)-OFF-(ON)

SPECIFICATIONS:

Material:
 Body: Bakelite, Color: Red Brown
 Lever: Brass, Nickel plated
 Terminal: Brass, Silver plated
 Electrical:

Rating: 10A @ 125V AC
 6A @ 250V AC
 Contact resistance: 50 mΩ max

Insulation resistance: 1000 MΩ min (500VDC)
 Dielectric withstanding voltage: 1500V AC for 1 minute
 Electrical Life: 10,000 cycles
 Temperature Rating:

Operating temperature: -25°C to +85°C
 Environmental:

Lead free, RoHS compliant

UNLESS OTHERWISE SPECIFIED ALL DIMENSIONS ARE INCHES [MM]. TOLERANCES: EXCEPT AS NOTED

INCHES		HOLES	
.x	± .10	∅x	± .10
.xx	± .020	∅xx	± .015
.xxx	± .015	∅xxx	± .010

ADAM TECH 909 Rahway Avenue,
 Union, NJ 07083
 Phone: 908-687-5000
 Fax: 908-687-5710

DRAWN	OW	11/11/20
CHECKED	AC	11/11/20
APPROVED		

TITLE SWITCH, TOGGLE MEDIUM, SPDT,
 SCREW LUG

THIS DRAWING CONTAINS INFORMATION THAT IS PROPRIETARY AND SHOULD NOT BE USED WITHOUT PRIOR WRITTEN PERMISSION FROM ADAM TECH

SIZE X	PART NO. SW-T1-2X-D-K1	REV. D
REF: S00206C	SCALE: NTS	SHEET 1 OF 1