

100 V, 30 A PowerFLAT power Schottky rectifier

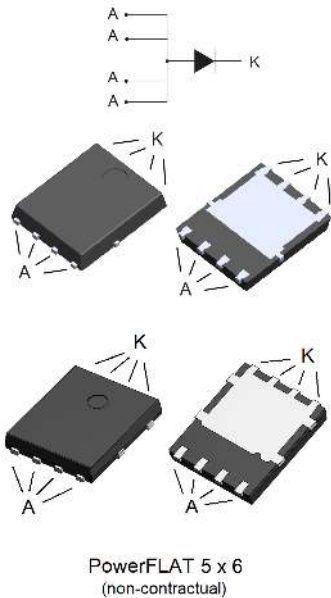

Features

- Low forward voltage drop
- Very low conduction losses
- Negligible switching losses
- Extremely fast switching
- Low thermal resistance
- Avalanche rated
- High integration
- Thin package: 1 mm
- ECOPACK2 compliant

Applications

- Switching diode
- SMPS
- DC/DC converter
- Telecom power

Description

This Schottky rectifier is ideally suited for switch mode power supply and high frequency DC to DC converters.

Packaged in PowerFLAT 5x6, the [STPS30H100DJF](#) is optimized for use in low voltage high frequency inverters, free-wheeling and polarity protection applications. Its low profile was especially designed to be used in applications with space-saving constraints.

Product status link

[STPS30H100DJF](#)

Product summary

Symbol	Value
$I_{F(AV)}$	30 A
V_{RRM}	100 V
T_j (max.)	150 °C
V_F (typ.)	0.56 V

1 Characteristics

Table 1. Absolute ratings (limiting values at 25 °C, unless otherwise specified, anode terminals short-circuited)

Symbol	Parameter	Value	Unit
V _{RRM}	Repetitive peak reverse voltage	100	V
I _{F(RMS)}	Forward rms current	45	A
I _{F(AV)}	Average forward current, $\delta = 0.5$ square wave	T _c = 100 °C	A
I _{FSM}	Surge non repetitive forward current	t _p = 10 ms sinusoidal	A
P _{ARM}	Repetitive peak avalanche power	t _p = 10 μ s, T _j = 125 °C	W
T _{stg}	Storage temperature range	-65 to +175	°C
T _j	Maximum operating junction temperature ⁽¹⁾	+150	°C

1. $(dP_{tot}/dT_j) < (1/R_{th(j-a)})$ condition to avoid thermal runaway for a diode on its own heatsink.

Table 2. Thermal resistance parameters

Symbol	Parameter	Max.	Unit
R _{th(j-c)}	Junction to case	2	°C/W

For more information, please refer to the following application note:

- [AN5046](#): Printed circuit board assembly recommendations for STMicroelectronics PowerFLAT packages

Table 3. Static electrical characteristics (anode terminals short-circuited)

Symbol	Parameter	Test conditions	Min.	Typ.	Max.	Unit
I _R ⁽¹⁾	Reverse leakage current	T _j = 25 °C	V _R = V _{RRM}	-	6	μ A
		T _j = 125 °C		-	2.5	6.5
V _F ⁽²⁾	Forward voltage drop	T _j = 25 °C	I _F = 15 A	-	0.76	V
		T _j = 125 °C		-	0.56	
		T _j = 25 °C	I _F = 30 A	-	0.84	
		T _j = 125 °C		-	0.63	

1. Pulse test: t_p = 5 ms, $\delta < 2\%$

2. Pulse test: t_p = 380 μ s, $\delta < 2\%$

To evaluate the conduction losses, use the following equation:

$$P = 0.60 \times I_{F(AV)} + 0.00367 \times I_{F(RMS)}^2$$

For more information, please refer to the following application notes related to the power losses:

- [AN604](#): Calculation of conduction losses in a power rectifier
- [AN4021](#): Calculation of reverse losses in a power diode

1.1 Characteristics (curves)

Figure 1. Average forward power dissipation versus average forward current

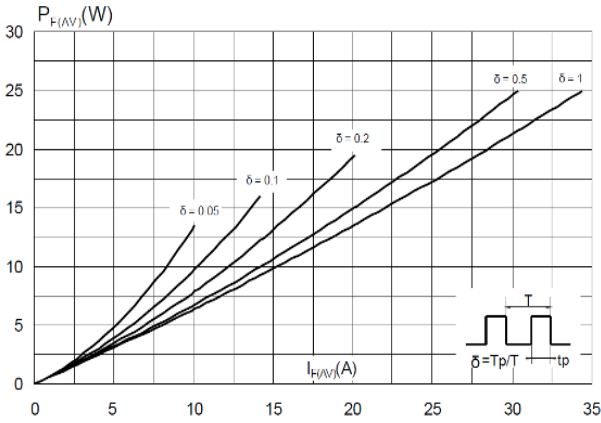

Figure 2. Average forward current versus ambient temperature ($\delta = 0.5$)

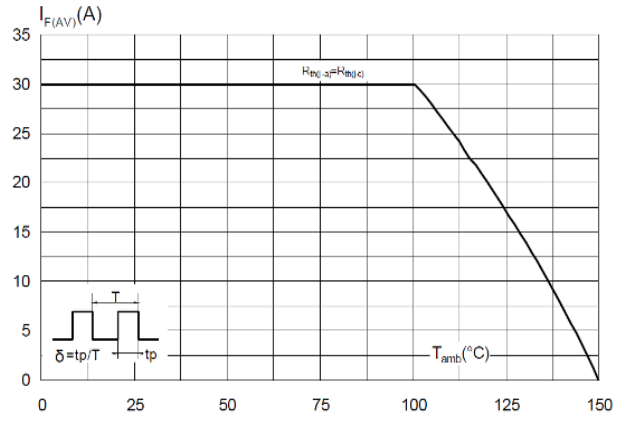

Figure 3. Normalized avalanche power derating versus pulse duration

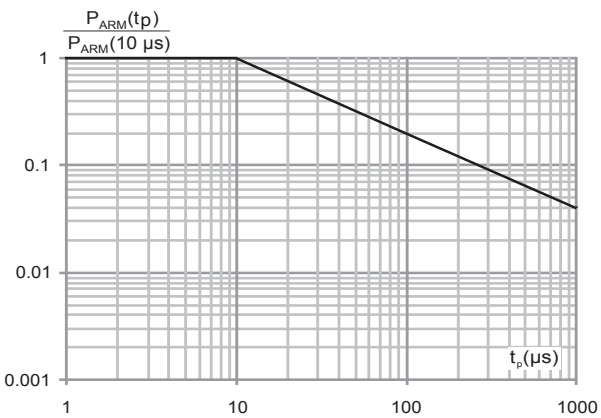

Figure 4. Relative variation of thermal impedance junction to case versus pulse duration

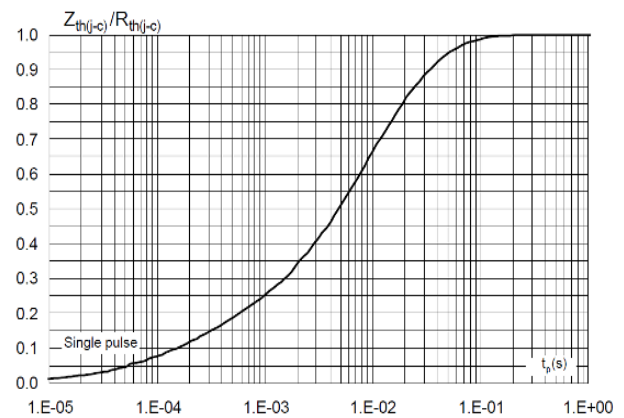

Figure 5. Reverse leakage current versus reverse voltage applied (typical values)

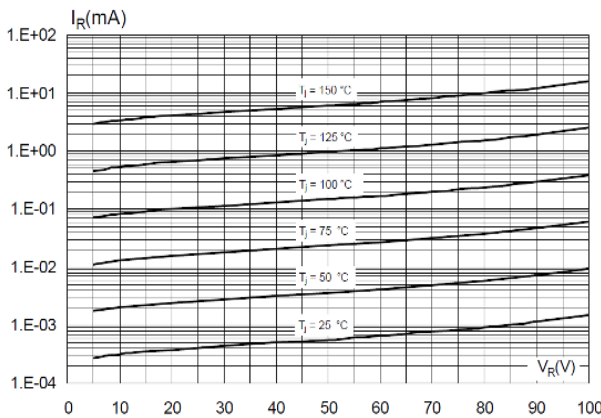

Figure 6. Junction capacitance versus reverse voltage applied (typical values)

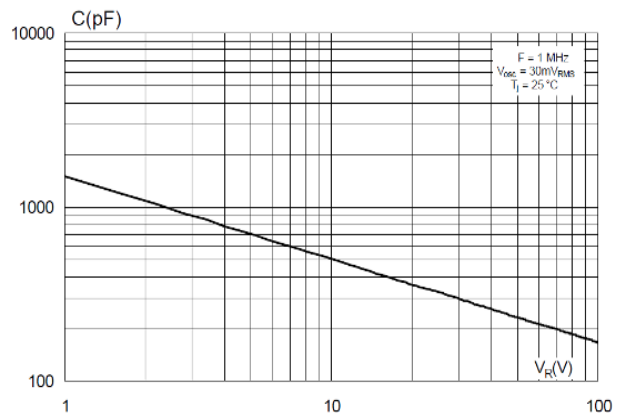

Figure 7. Forward voltage drop versus forward current

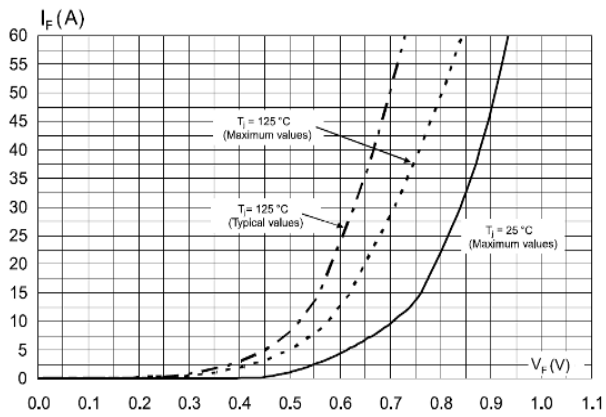
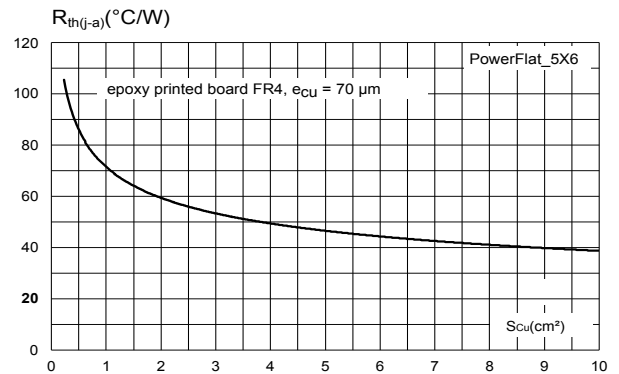

Figure 8. Thermal resistance junction to ambient versus copper surface under tab



2 Package information

In order to meet environmental requirements, ST offers these devices in different grades of **ECOPACK** packages, depending on their level of environmental compliance. ECOPACK specifications, grade definitions and product status are available at: www.st.com. ECOPACK is an ST trademark.

2.1 PowerFLAT 5x6 package information

- Epoxy meets UL 94, V0
- Cooling method: by conduction (C)

Figure 9. PowerFLAT 5x6 package outline (non-contractual)

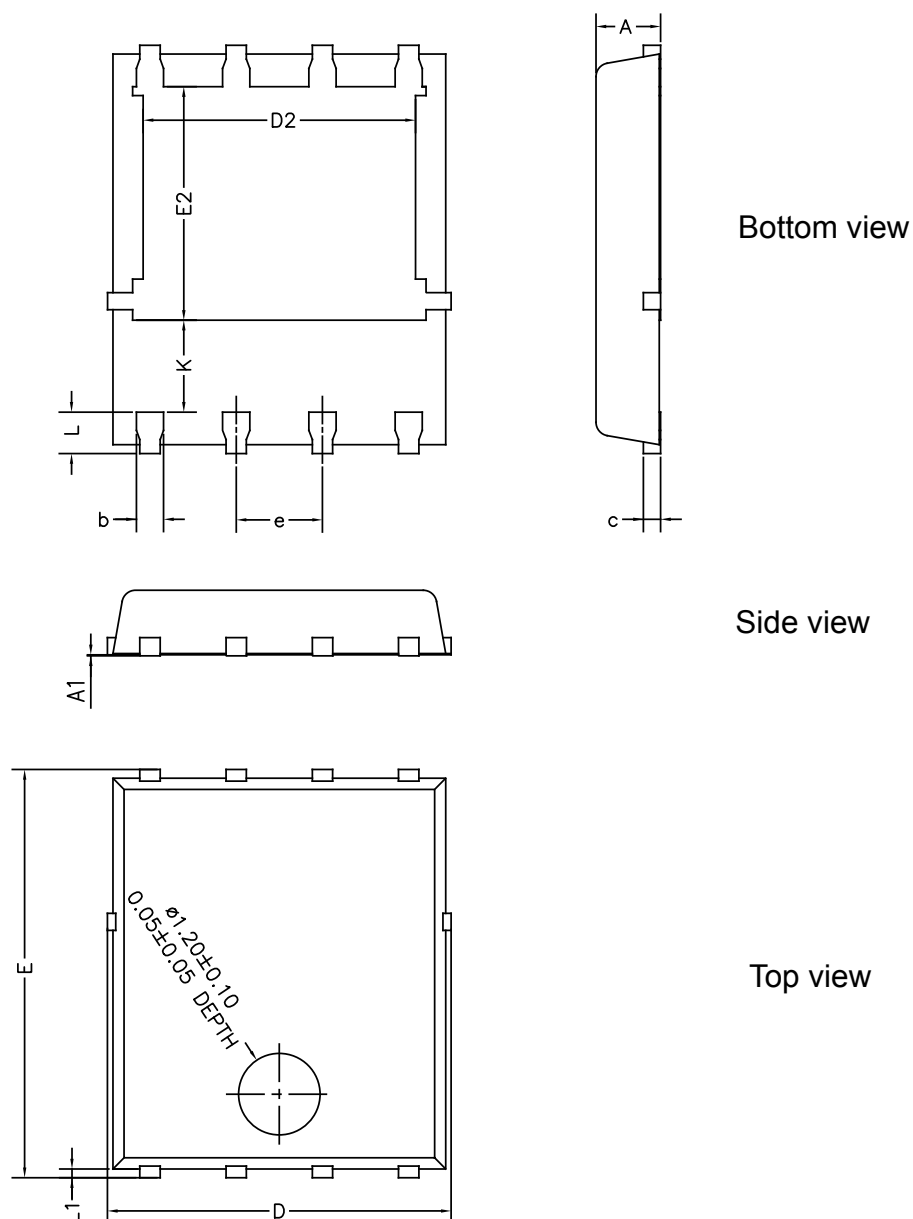

Note: This package drawing may slightly differ from the physical package. However, all the specified dimensions are guaranteed.

Table 4. PowerFLAT 5x6 mechanical data

Ref	Dimensions					
	Millimeters			Inches (for reference only)		
	Min.	Typ.	Max.	Min.	Typ.	Max.
A	0.80		1.00	0.031		0.039
A1	0.00		0.05	0.000		0.002
b	0.30		0.50	0.01		0.02
c		0.25			0.010	
D	4.80		5.40	0.189		0.212
D2	3.91		4.45	0.154		0.175
e		1.27			0.050	
E	5.90		6.35	0.232		0.250
E2	3.34		3.70	0.138		0.146
L	0.50		0.80	0.020		0.031
K	1.10		1.575	0.015		0.023
L1	0.05	0.15	0.25	0.002	0.006	0.009

Figure 10. PowerFLAT 5x6 recommended footprint (dimensions are in mm)

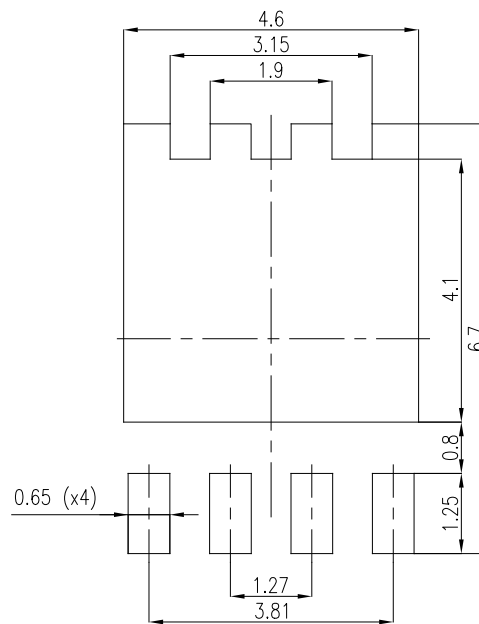

Note: For packing information, please refer to [TN1173](#).

3 Ordering information

Table 5. Ordering information

Order code	Marking	Package	Weight	Base qty.	Delivery mode
STPS30H100DJF-TR	PS30 H100	PowerFLAT 5x6	0.095 g	3000	Tape and reel

Revision history

Table 6. Document revision history

Date	Version	Changes
29-Mar-2012	1	Initial release.
26-Jun-2017	2	Updated cover image and Section 2.1: "PowerFLAT™5x6 package information".
20-Oct-2022	3	Updated cover image and Section 2.1 .

IMPORTANT NOTICE – READ CAREFULLY

STMicroelectronics NV and its subsidiaries (“ST”) reserve the right to make changes, corrections, enhancements, modifications, and improvements to ST products and/or to this document at any time without notice. Purchasers should obtain the latest relevant information on ST products before placing orders. ST products are sold pursuant to ST’s terms and conditions of sale in place at the time of order acknowledgment.

Purchasers are solely responsible for the choice, selection, and use of ST products and ST assumes no liability for application assistance or the design of purchasers’ products.

No license, express or implied, to any intellectual property right is granted by ST herein.

Resale of ST products with provisions different from the information set forth herein shall void any warranty granted by ST for such product.

ST and the ST logo are trademarks of ST. For additional information about ST trademarks, refer to www.st.com/trademarks. All other product or service names are the property of their respective owners.

Information in this document supersedes and replaces information previously supplied in any prior versions of this document.

© 2022 STMicroelectronics – All rights reserved