

Audio Subsystem with Mono Class D Speaker and Class H Headphone Amplifiers

MAX97001

General Description

The MAX97001 mono audio subsystem combines a mono speaker amplifier with a stereo headphone amplifier and an analog DPST switch. The headphone and speaker amplifiers have independent volume control and on/off control. The 4 inputs are configurable as 2 differential inputs or 4 single-ended inputs.

The entire subsystem is designed for maximum efficiency. The high-efficiency, 700mW, Class D speaker amplifier operates directly from the battery and consumes no more than 1 μ A in shutdown mode. The Class H headphone amplifier utilizes a dual-mode charge pump to maximize efficiency while outputting a ground-referenced signal that does not require output coupling capacitors.

The speaker amplifier incorporates a distortion limiter to automatically reduce the volume level when excessive clipping occurs. This allows high gain for low-level signals without compromising the quality of large signals.

All control is performed using the 2-wire I²C interface. The MAX97001 operates over the extended -40°C to +85°C temperature range, and is available in the 2mm x 2.5mm, 20-bump, WLP package (0.5mm pitch).

Applications

Cell Phones
Portable Multimedia Players

Features

- ◆ 2.7V to 5.5V Speaker Supply Voltage
- ◆ 1.6V to 2V Headphone Supply Voltage
- ◆ 700mW Speaker Output ($V_{PVDD} = 3.7V$, $Z_{SPK} = 8\Omega + 68\mu H$)
- ◆ 37mW/Channel Headphone Output ($R_{HP} = 16\Omega$)
- ◆ Low-Emission Class D Amplifier
- ◆ Efficient Class H Headphone Amplifier
- ◆ Ground-Referenced Headphone Outputs
- ◆ 2 Stereo Single-Ended/Mono Differential Inputs
- ◆ Integrated Distortion Limiter (Speaker Outputs)
- ◆ Integrated DPST Analog Switch
- ◆ No Clicks and Pops
- ◆ TDMA Noise Free
- ◆ 2mm x 2.5mm, 20-Bump, 0.5mm Pitch WLP Package

Ordering Information

| PART | TEMP RANGE | PIN-PACKAGE |
|--------------|----------------|-------------|
| MAX97001EWP+ | -40°C to +85°C | 20 WLP |

+Denotes a lead(Pb)-free/RoHS-compliant package.

Simplified Block Diagram

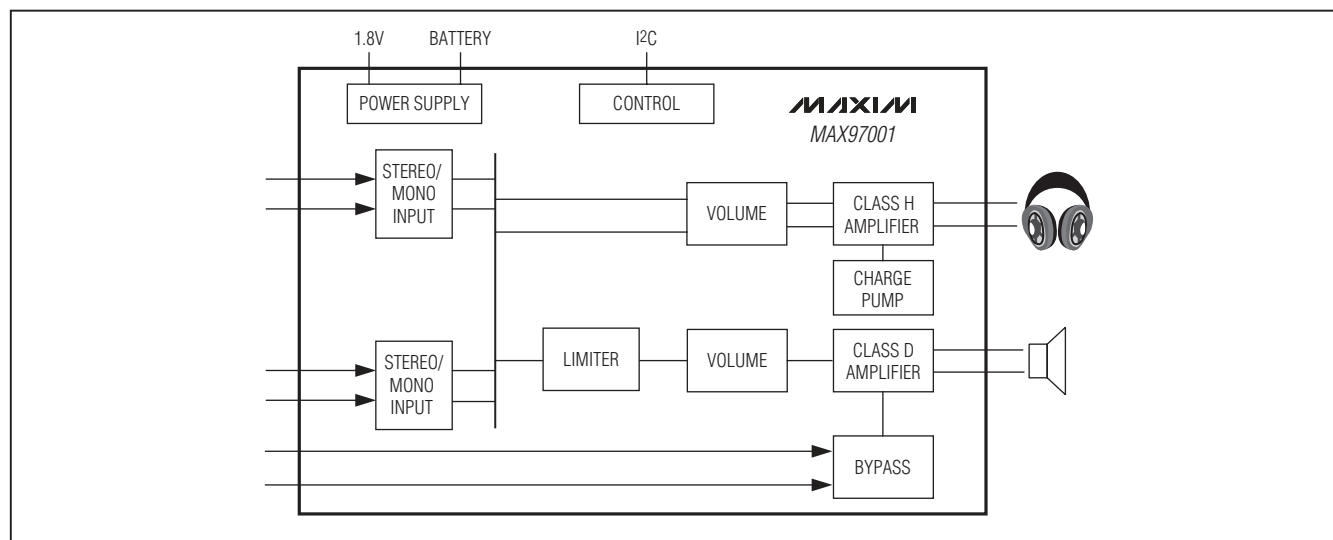

Audio Subsystem with Mono Class D Speaker and Class H Headphone Amplifiers

TABLE OF CONTENTS

| | |
|--|----|
| General Description | 1 |
| Applications | 1 |
| Features | 1 |
| Simplified Block Diagram | 1 |
| Ordering Information | 1 |
| Functional Diagram/Typical Application Circuit | 4 |
| Absolute Maximum Ratings | 5 |
| Electrical Characteristics | 5 |
| Digital I/O Characteristics | 9 |
| I ² C TIMING Characteristics | 10 |
| Typical Operating Characteristics | 11 |
| Pin Configuration | 17 |
| Pin Description | 17 |
| Detailed Description | 18 |
| Signal Path | 18 |
| Mixers | 18 |
| Class D Speaker Amplifier | 18 |
| Ultra-Low EMI Filterless Output Stage | 20 |
| Distortion Limiter | 21 |
| Analog Switch | 21 |
| Headphone Amplifier | 21 |
| DirectDrive | 21 |
| Charge Pump | 22 |
| Class H Operation | 22 |
| Low-Power Mode | 22 |
| I ² C Slave Address | 22 |
| I ² C Registers | 23 |
| Table 1. Register Map | 23 |
| Table 2. Input Register | 24 |
| Mixers | 25 |
| Table 3. Mixer Registers | 25 |
| Volume Control | 26 |
| Table 4. Volume Control Registers | 26 |
| Distortion Limiter | 29 |
| Table 5. Distortion Limiter Register | 29 |
| Power Management | 29 |

Audio Subsystem with Mono Class D Speaker and Class H Headphone Amplifiers

MAX97001

TABLE OF CONTENTS (CONTINUED)

| | |
|---|----|
| Table 6. Power Management Register | 29 |
| Charge-Pump Control | 30 |
| Table 7. Charge-Pump Control Register | 30 |
| I ² C Serial Interface | 30 |
| Bit Transfer | 30 |
| START and STOP Conditions | 30 |
| Early STOP Conditions | 31 |
| Slave Address | 31 |
| Acknowledge | 31 |
| Write Data Format | 31 |
| Read Data Format | 32 |
| Applications Information | 32 |
| Filterless Class D Operation | 33 |
| RF Susceptibility | 33 |
| Component Selection | 34 |
| Optional Ferrite Bead Filter | 34 |
| Input Capacitor | 34 |
| Charge-Pump Capacitor Selection | 34 |
| Charge-Pump Flying Capacitor | 34 |
| Charge-Pump Holding Capacitor | 34 |
| Supply Bypassing, Layout, and Grounding | 34 |
| WLP Applications Information | 35 |
| Package Information | 36 |

Audio Subsystem with Mono Class D Speaker and Class H Headphone Amplifiers

Functional Diagram/Typical Application Circuit

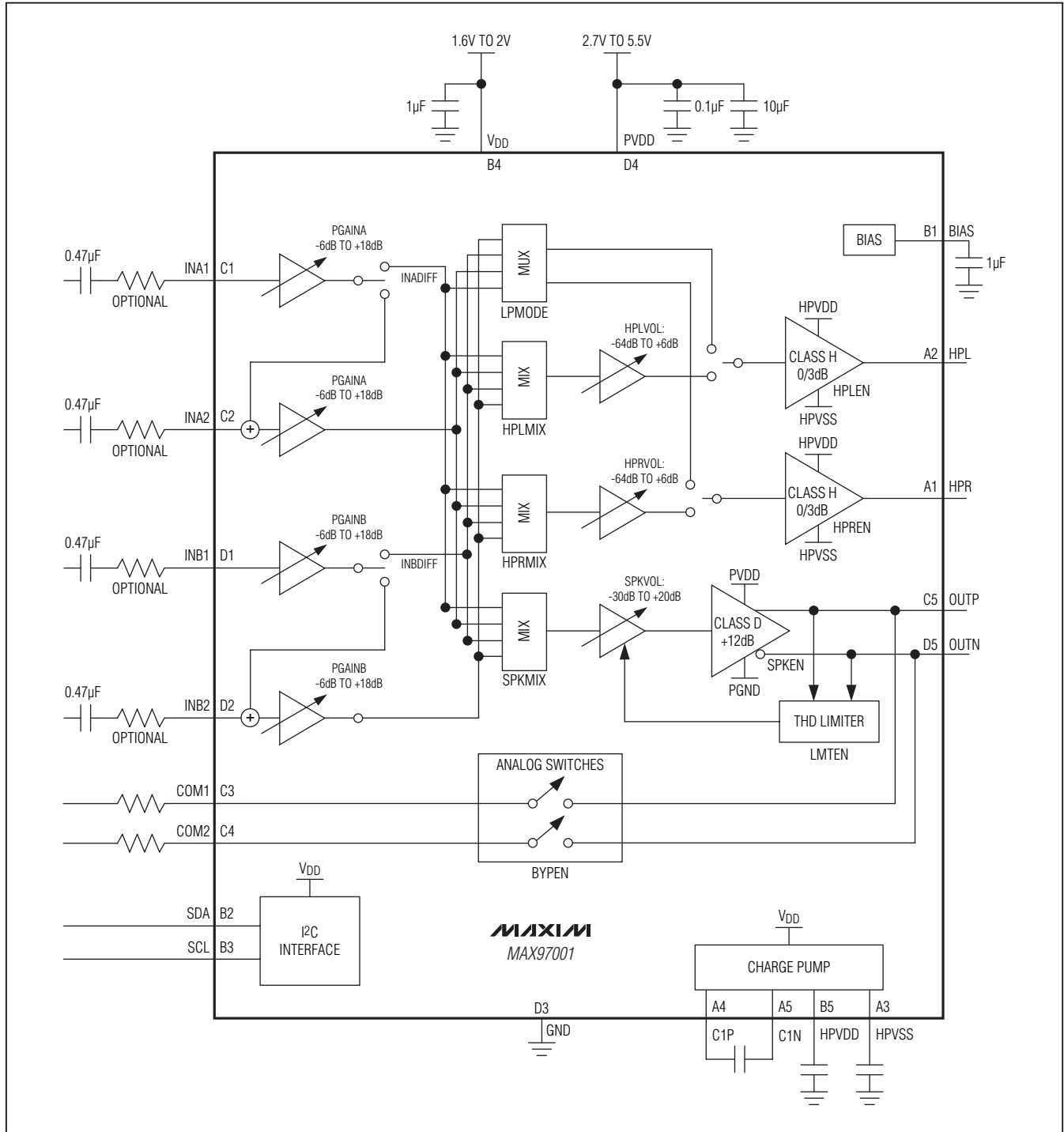

Audio Subsystem with Mono Class D Speaker and Class H Headphone Amplifiers

ABSOLUTE MAXIMUM RATINGS

(Voltages with respect to GND.)

| | |
|--|----------------------------------|
| V _{DD} , HPVDD | -0.3V to +2.2V |
| PVDD | -0.3V to +6.0V |
| HPVSS | -2.2V to +0.3V |
| C1N | (HPVSS - 0.3V) to (HPVDD + 0.3V) |
| C1P | -0.3V to (HPVDD + 0.3V) |
| HPL, HPR | (HPVSS - 0.3V) to (HPVDD + 0.3V) |
| INA1, INA2, INB1, INB2, BIAS | -0.3V to +6.0V |
| SDA, SCL | -0.3V to +6.0V |
| COM1, COM2, OUTP, OUTN | -0.3V to (PVDD + 0.3V) |
| Continuous Current In/Out of PVDD, GND, OUT_ | ±800mA |
| Continuous Current In/Out of HPR, HPL, VDD | ±140mA |
| Continuous Current In/Out of COM1, COM2 | ±150mA |

| | |
|---|-----------------|
| Continuous Input Current (all other pins) | ±20mA |
| Duration of OUT_ Short Circuit to GND or PVDD | Continuous |
| Duration of Short Circuit Between OUTP and OUTN | Continuous |
| Duration of HP_ Short Circuit to GND or V _{DD} | Continuous |
| Continuous Power Dissipation (T _A = +70°C) 20-Bump WLP Multilayer Board (derate 13mW/°C above +70°C) | 1040mW |
| Junction Temperature | +150°C |
| Operating Temperature Range | -40°C to +85°C |
| Storage Temperature Range | -65°C to +150°C |
| Soldering Temperature (reflow) | +260°C |

Stresses beyond those listed under "Absolute Maximum Ratings" may cause permanent damage to the device. These are stress ratings only, and functional operation of the device at these or any other conditions beyond those indicated in the operational sections of the specifications is not implied. Exposure to absolute maximum rating conditions for extended periods may affect device reliability.

ELECTRICAL CHARACTERISTICS

(V_{DD} = 1.8V, V_{PVDD} = 3.7V, V_{GND} = 0V. Input signal applied at INA configured single-ended, preamp gain = 0dB, HPLVOL = HPRVOL = SPKVOL = 0dB, speaker loads (Z_{SPK}) connected between OUTP and OUTN. Headphone loads (R_{HP}) connected from HPL or HPR to GND. SDA and SCL pullup voltage = 1.8V. Z_{SPK} = ∞, R_{HP} = ∞. C_{C1P-C1N} = C_{HPVDD} = C_{HPVSS} = C_{BIAS} = 1μF. T_A = T_{MIN} to T_{MAX}, unless otherwise noted. Typical values are at T_A = +25°C.) (Note 1)

| PARAMETER | SYMBOL | CONDITIONS | | MIN | TYP | MAX | UNITS |
|---|-------------------|---|--|------|------|------|-------|
| Speaker Amplifier Supply Voltage Range | PVDD | Guaranteed by PSRR test | | 2.7 | | 5.5 | V |
| Headphone Amplifier Supply Voltage Range | V _{DD} | Guaranteed by PSRR test | | 1.6 | | 2 | V |
| Quiescent Supply Current | | Low-power headphone mode, T _A = +25°C | I _{VDD} | | 1.35 | 1.85 | mA |
| | | | I _{PVDD} | | 0.35 | 0.55 | |
| | | HP mode, T _A = +25°C, stereo SE input on INA, INB disabled | I _{VDD} | | 1.35 | 1.85 | |
| | | | I _{PVDD} | | 0.75 | 1.15 | |
| | | SPK mode, T _A = +25°C mono differential Input on INB, INA disabled | I _{VDD} | | 0.32 | 0.6 | |
| | | | I _{PVDD} | | 1.38 | 2.2 | |
| SPK + HP mode, T _A = +25°C, stereo SE input on INA, INB disabled | I _{VDD} | | 1.35 | 1.85 | | | |
| | I _{PVDD} | | 1.8 | 2.7 | | | |
| Shutdown Current | I _{SHDN} | T _A = +25°C, V _{SHDN} = 0V | I _{VDD} + I _{PVDD} | | 8 | | μA |
| | | | V _{VDD} = 0V, I _{PVDD} | | < 1 | | |
| Turn-On Time | t _{ON} | Time from power-on to full operation, including soft-start | | | 10 | | ms |
| Input Resistance | R _{IN} | T _A = +25°C, internal gain | Gain = -6dB, -3dB | | 41.2 | | kΩ |
| | | | Gain = 0dB, 3dB, 6dB, 9dB | 16 | 20.6 | 27 | |
| | | | Gain = +18dB | 5.5 | 7.2 | 9.6 | |

Audio Subsystem with Mono Class D Speaker and Class H Headphone Amplifiers

ELECTRICAL CHARACTERISTICS (continued)

(V_{DD} = 1.8V, V_{PVDD} = 3.7V, V_{GND} = 0V. Input signal applied at INA configured single-ended, preamp gain = 0dB, HPLVOL = HPRVOL = SPKVOL = 0dB, speaker loads (Z_{SPK}) connected between OUTP and OUTN. Headphone loads (R_{HP}) connected from HPL or HPR to GND. SDA and SCL pullup voltage = 1.8V. Z_{SPK} = ∞, R_{HP} = ∞. C_{C1P-C1N} = C_{HPVDD} = C_{HPVSS} = C_{BIAS} = 1μF. T_A = T_{MIN} to T_{MAX}, unless otherwise noted. Typical values are at T_A = +25°C.) (Note 1)

| PARAMETER | SYMBOL | CONDITIONS | MIN | TYP | MAX | UNITS |
|---------------------------------------|-------------------|--|--|-----|-------|------------------|
| Feedback Resistance | R _F | T _A = +25°C, external gain | 19 | 20 | 21 | kΩ |
| Maximum Input Signal Swing | | Preamp = 0dB | 2.3 | | | V _{P-P} |
| | | Preamp = +18dB | 0.29 | | | |
| | | Preamp = external gain | 2.3 x R _{INEX} /R _F | | | |
| Common-Mode Rejection Ratio | CMRR | f = 1kHz (differential input mode), gain = 0dB | 55 | | | dB |
| | | f = 1kHz (differential input mode), gain = 18dB | 32 | | | |
| Input DC Voltage | | IN__ inputs | 1.125 | 1.2 | 1.275 | V |
| Bias Voltage | V _{BIAS} | | 1.13 | 1.2 | 1.27 | V |
| SPEAKER AMPLIFIER | | | | | | |
| Output Offset Voltage | V _{OS} | T _A = +25°C, SPKM = 1 | ±0.5 | | ±4 | mV |
| | | T _A = +25°C, SPKMIX = 0x01, IN_DIFF = 0 | ±1.5 | | | |
| Click-and-Pop Level | K _{CP} | Peak voltage, T _A = +25°C, A-weighted, 32 samples per second, volume at mute (Note 2) | Into shutdown | -70 | | dBV |
| | | | Out of shutdown | -70 | | |
| Power-Supply Rejection Ratio (Note 2) | PSRR | T _A = +25°C | V _{PVDD} = 2.7V to 5.5V | 50 | 77 | dB |
| | | | f = 217Hz, 200mV _{P-P} ripple | 73 | | |
| | | | f = 1kHz, 200mV _{P-P} ripple | 73 | | |
| | | | f = 20kHz, 200mV _{P-P} ripple | 57 | | |
| Output Power (Note 3) | | THD+N ≤ 1%, f = 1kHz, Z _{SPK} = 8Ω + 68μH | V _{PVDD} = 4.2V | 920 | | mW |
| | | | V _{PVDD} = 3.7V | 700 | | |
| | | | V _{PVDD} = 3.3V | 550 | | |
| Total Harmonic Distortion Plus Noise | THD+N | f = 1kHz, P _{OUT} = 360mW, T _A = +25°C, R _{SPK} = 8Ω | 0.05 | 0.6 | | % |
| Signal-to-Noise Ratio | SNR | A-weighted, SPKMIX = 0x03, referenced to 700mW | IN_DIFF = 0 (single-ended) | 96 | | dB |
| | | | IN_DIFF = 1 (differential) | 96 | | |
| Oscillator Frequency | f _{OSC} | | 250 | | | kHz |
| Spread-Spectrum Bandwidth | | | ±20 | | | kHz |
| Gain | | | 11.5 | 12 | 12.5 | dB |
| Current Limit | | | 1.5 | | | A |

Audio Subsystem with Mono Class D Speaker and Class H Headphone Amplifiers

MAX97001

ELECTRICAL CHARACTERISTICS (continued)

(V_{DD} = 1.8V, V_{PVDD} = 3.7V, V_{GND} = 0V. Input signal applied at INA configured single-ended, preamp gain = 0dB, HPLVOL = HPRVOL = SPKVOL = 0dB, speaker loads (Z_{SPK}) connected between OUTP and OUTN. Headphone loads (R_{HP}) connected from HPL or HPR to GND. SDA and SCL pullup voltage = 1.8V. Z_{SPK} = ∞, R_{HP} = ∞. CC1P-C1N = CHPVDD = CHPVSS = CBIAS = 1μF. T_A = T_{MIN} to T_{MAX}, unless otherwise noted. Typical values are at T_A = +25°C.) (Note 1)

| PARAMETER | SYMBOL | CONDITIONS | MIN | TYP | MAX | UNITS | |
|---------------------------------------|--------------------|--|---|----------------------------|----------------------------|-------|--|
| Efficiency | η | P _{OUT} = 600mW, f = 1kHz | | 87 | | % | |
| Output Noise | | A-weighted, (SPKMIX = 0x01), IN_DIFF = 1, SPKVOL = -30dB | | 37 | | μVRMS | |
| CHARGE PUMP | | | | | | | |
| Charge-Pump Frequency | | V _{HPL} = V _{HPR} = 0V, T _A = +25°C | 80 | 83 | 85 | kHz | |
| | | V _{HPL} = V _{HPR} = 0.2V | | 665 | | | |
| | | V _{HPL} = V _{HPR} = 0.5V | | 500 | | | |
| Positive Output Voltage | V _{HPVDD} | V _{HPL} , V _{HPR} > V _{TH} | | V _{DD} | | V | |
| | | V _{HPL} , V _{HPR} < V _{TH} | | V _{DD} /2 | | | |
| Negative Output Voltage | V _{HPVSS} | V _{HPL} , V _{HPR} > V _{TH} | | -V _{DD} | | V | |
| | | V _{HPL} , V _{HPR} < V _{TH} | | -V _{DD} /2 | | | |
| Headphone Output Voltage Threshold | V _{TH1} | Output voltage at which the charge pump switches between fast and slow clock | ±V _{DD} x 0.05 | ±V _{DD} x 0.08 | ±V _{DD} x 0.13 | V | |
| | V _{TH2} | Output voltage at which the charge pump switches modes, V _{OUT} rising or falling | ±V _{DD} x 0.21 | ±V _{DD} x 0.25 | ±V _{DD} x 0.3 | | |
| Mode Transition Timeouts | | Time it takes for the charge pump to transition from Invert to split mode | | 32 | | ms | |
| | | Time it takes for the charge pump to transition from split to invert mode | | 20 | | μs | |
| HEADPHONE AMPLIFIERS | | | | | | | |
| Output Offset Voltage | V _{OS} | T _A = +25°C, volume at mute | | ±0.15 | ±0.6 | mV | |
| | | T _A = +25°C, HP_MIX = 0x1, IN_DIFF = 0 | | ±0.5 | | | |
| Click-and-Pop Level | KCP | Peak voltage, T _A = +25°C, A-weighted, 32 samples per second, volume at mute (Note 2) | Into shutdown | | -74 | dBV | |
| | | | Out of shutdown | | -74 | | |
| Power-Supply Rejection Ratio (Note 2) | PSRR | T _A = +25°C | V _{DD} = 1.62V to 1.98V | 70 | 85 | dB | |
| | | | f = 217Hz, V _{RIPPLE} = 200mV _{P-P} | | 84 | | |
| | | | f = 1kHz, V _{RIPPLE} = 200mV _{P-P} | | 80 | | |
| | | | f = 20kHz, V _{RIPPLE} = 200mV _{P-P} | | 69 | | |

Audio Subsystem with Mono Class D Speaker and Class H Headphone Amplifiers

ELECTRICAL CHARACTERISTICS (continued)

(V_{DD} = 1.8V, V_{PVDD} = 3.7V, V_{GND} = 0V. Input signal applied at INA configured single-ended, preamp gain = 0dB, HPLVOL = HPRVOL = SPKVOL = 0dB, speaker loads (Z_{SPK}) connected between OUTP and OUTN. Headphone loads (R_{HHP}) connected from HPL or HPR to GND. SDA and SCL pullup voltage = 1.8V. Z_{SPK} = ∞, R_{HHP} = ∞. C_{C1P-C1N} = C_{HPVDD} = C_{HPVSS} = C_{BIAS} = 1μF. T_A = T_{MIN} to T_{MAX}, unless otherwise noted. Typical values are at T_A = +25°C.) (Note 1)

| PARAMETER | SYMBOL | CONDITIONS | MIN | TYP | MAX | UNITS |
|--------------------------------------|------------------|--|---|------|------|-------|
| Output Power | P _{OUT} | THD+N = 1%, f = 1kHz | R _{HHP} = 16Ω | 37 | | mW |
| | | | R _{HHP} = 32Ω | 30 | | |
| Channel-to-Channel Gain Tracking | | T _A = +25°C, HPL to HPR, HPLMIX = 0x01, HPRMIX = 0x02, IN_DIFF = 0 | | ±0.3 | ±2.5 | % |
| Total Harmonic Distortion Plus Noise | THD+N | P _{OUT} = 10mW, f = 1kHz | R _{HHP} = 32Ω | 0.02 | | % |
| | | | R _{HHP} = 16Ω | 0.03 | 0.1 | |
| Signal-to-Noise Ratio | SNR | A-weighted, R _{HHP} = 16Ω, HPLMIX = 0x01, HPRMIX = 0x02, IN_DIFF = 0 | | 100 | | dB |
| Slew Rate | SR | | | 0.35 | | V/μs |
| Capacitive Drive | CL | | | 200 | | pF |
| Crosstalk | | HPL to HPR, HPR to HPL, f = 20Hz to 20kHz | | 68 | | dB |
| ANALOG SWITCH | | | | | | |
| On-Resistance | R _{ON} | I _{NC} = 20mA, V _{COM} = 0V and PVDD, SWEN = 1 | T _A = +25°C | 1.6 | 4 | Ω |
| | | | T _A = T _{MIN} to T _{MAX} | | 5.2 | |
| Total Harmonic Distortion Plus Noise | THD+N | V _{DIFCOM} = 2VP-P, V _{CMCOM} = PVDD/2, f = 1kHz, SWEN = 1, Z _{SPK} = 8Ω + 68μH | 10Ω in series with each switch | 0.05 | | % |
| | | | No series resistors | 0.3 | | |
| Off-Isolation | | SWEN = 0, COM1 and COM2 to GND = 50Ω, f = 10kHz, referred to signal applied to OUTP and OUTN | | 90 | | dB |
| PREAMPLIFIER | | | | | | |
| Gain | | PGAIN_ = 000 | -6.5 | -6 | -5.5 | dB |
| | | PGAIN_ = 001 | -3.5 | -3 | -2.5 | |
| | | PGAIN_ = 010 | -0.5 | 0 | +0.5 | |
| | | PGAIN_ = 011 | 2.5 | 3 | 3.5 | |
| | | PGAIN_ = 100 | 5.5 | 6 | 6.5 | |
| | | PGAIN_ = 101 | 8.5 | 9 | 9.5 | |
| | | PGAIN_ = 110 | 17.5 | 18 | 18.5 | |
| VOLUME CONTROL | | | | | | |
| Volume Level | | HP_VOL = 0x1F | 5.5 | 6 | 6.5 | dB |
| | | HP_VOL = 0x00 | -68 | -64 | -60 | |
| | | SPKVOL = 0x3F | 19 | 20 | -21 | |
| | | SPKVOL = 0x00 | -31 | -30 | -29 | |

Audio Subsystem with Mono Class D Speaker and Class H Headphone Amplifiers

ELECTRICAL CHARACTERISTICS (continued)

(V_{DD} = 1.8V, V_{PVDD} = 3.7V, V_{GND} = 0V. Input signal applied at INA configured single-ended, preamp gain = 0dB, HPLVOL = HPRVOL = SPKVOL = 0dB, speaker loads (Z_{SPK}) connected between OUTP and OUTN. Headphone loads (R_{HP}) connected from HPL or HPR to GND. SDA and SCL pullup voltage = 1.8V. Z_{SPK} = ∞, R_{HP} = ∞. C_{C1P-C1N} = C_{HPVDD} = C_{HPVSS} = C_{BIAS} = 1μF. T_A = T_{MIN} to T_{MAX}, unless otherwise noted. Typical values are at T_A = +25°C.) (Note 1)

| PARAMETER | SYMBOL | CONDITIONS | MIN | TYP | MAX | UNITS |
|---------------------------------|--------|------------|-----------|-----|-----|-------|
| Mute Attenuation | | f = 1kHz | Speaker | 100 | | dB |
| | | | Headphone | 110 | | |
| Zero-Crossing Detection Timeout | | | | 100 | | ms |
| LIMITER | | | | | | |
| Attack Time | | | | 1 | | ms |
| Release Time Constant | | THDT1 = 0 | | 1.4 | | s |
| | | THDT1 = 1 | | 2.8 | | |

DIGITAL I/O CHARACTERISTICS

(V_{PVDD} = 3.7V, V_{GND} = 0V. T_A = T_{MIN} to T_{MAX}, unless otherwise noted. Typical values are at T_A = +25°C.) (Note 1)

| PARAMETER | SYMBOL | CONDITIONS | MIN | TYP | MAX | UNITS |
|---|------------------|-------------------------|------------------------|-----|------------------------|-------|
| DIGITAL INPUTS (SDA, SCL) | | | | | | |
| Input Voltage High | V _{IH} | | 0.75 x V _{DD} | | | V |
| Input Voltage Low | V _{IL} | | | | 0.35 x V _{DD} | V |
| Input Hysteresis | V _{HYS} | | | 200 | | mV |
| Input Capacitance | C _{IN} | | | 10 | | pF |
| Input Leakage Current | I _{IN} | T _A = +25°C | | | ±1.0 | μA |
| DIGITAL OUTPUTS (SDA Open Drain) | | | | | | |
| Output Low Voltage | V _{OL} | I _{SINK} = 3mA | | | 0.4 | V |

Audio Subsystem with Mono Class D Speaker and Class H Headphone Amplifiers

I²C TIMING CHARACTERISTICS

(VPVDD = 3.7V, VGND = 0V. TA = TMIN to TMAX, unless otherwise noted. Typical values are at TA = +25°C.) (Note 1)

| PARAMETER | SYMBOL | CONDITIONS | MIN | TYP | MAX | UNITS |
|---|---------------------|------------|------------------------|-----|-----|-------|
| Serial-Clock Frequency | f _{SCL} | | 0 | | 400 | kHz |
| Bus Free Time Between STOP and START Conditions | t _{BUF} | | 1.3 | | | μs |
| Hold Time (REPEATED) START Condition | t _{HD,STA} | | 0.6 | | | μs |
| SCL Pulse-Width Low | t _{LOW} | | 1.3 | | | μs |
| SCL Pulse-Width High | t _{HIGH} | | 0.6 | | | μs |
| Setup Time for a REPEATED START Condition | t _{SU,STA} | | 0.6 | | | μs |
| Data Hold Time | t _{HD,DAT} | | 0 | | 900 | ns |
| Data Setup Time | t _{SU,DAT} | | 100 | | | ns |
| SDA and SCL Receiving Rise Time | t _R | (Note 4) | 20 + 0.1C _B | | 300 | ns |
| SDA and SCL Receiving Fall Time | t _F | (Note 4) | 20 + 0.1C _B | | 300 | ns |
| SDA Transmitting Fall Time | t _F | (Note 4) | 20 + 0.1C _B | | 300 | ns |
| Setup Time for STOP Condition | t _{SU,STO} | | 0.6 | | | μs |
| Bus Capacitance | C _B | | | | 400 | pF |
| Pulse Width of Suppressed Spike | t _{SP} | | 0 | | 50 | ns |

Note 1: 100% production tested at TA = +25°C. Specifications over temperature limits are guaranteed by design.

Note 2: Amplifier inputs are AC-coupled to GND.

Note 3: Class D amplifier testing performed with a resistive load in series with an inductor to simulate an actual speaker load.

Note 4: C_B is in pF.

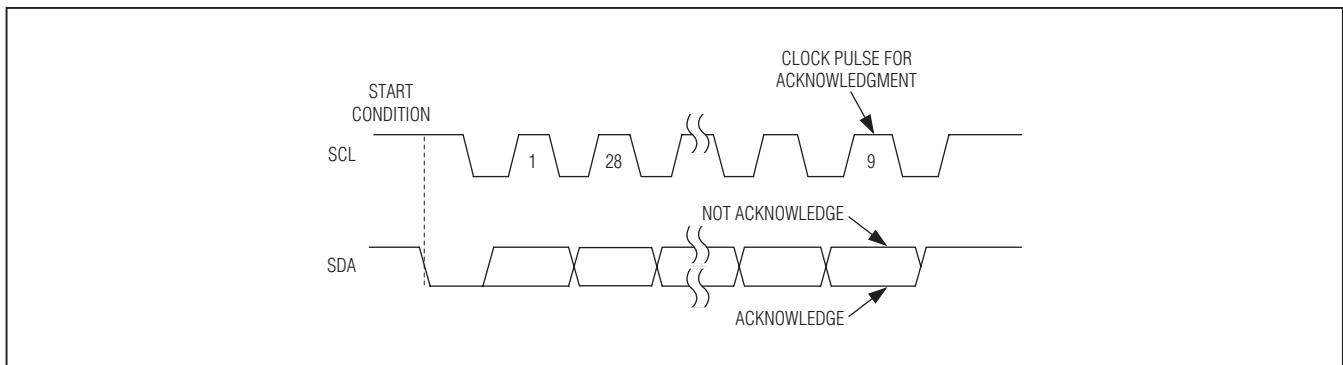

Figure 1. I²C Interface Timing Diagram

Audio Subsystem with Mono Class D Speaker and Class H Headphone Amplifiers

Typical Operating Characteristics

(VLDOIN = VPVDD = 3.7V, VGND = VPGND = 0V. Single-ended inputs, preamp gain = 0dB, HPLVOL = HPRVOL = SPKVOL = 0dB. Speaker loads (Z_{SPK}) connected between OUTP and OUTN. Headphone loads (R_{HP}) connected from HPL or HPR to GND. Z_{SPK} = ∞, R_{HP} = ∞. CC1P-C1N = CHPVDD = CHPVSS = CBIAS = 1μF. T_A = +25°C, unless otherwise noted.)

MAX97001

SUPPLY CURRENT vs. SUPPLY VOLTAGE

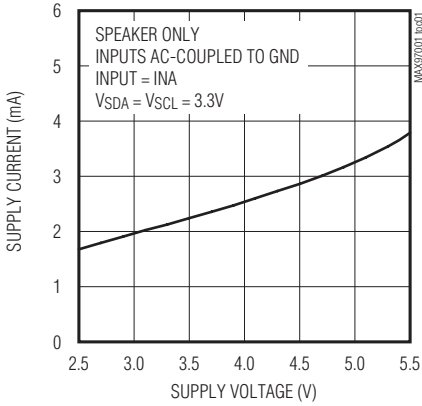

SHUTDOWN CURRENT vs. SUPPLY VOLTAGE

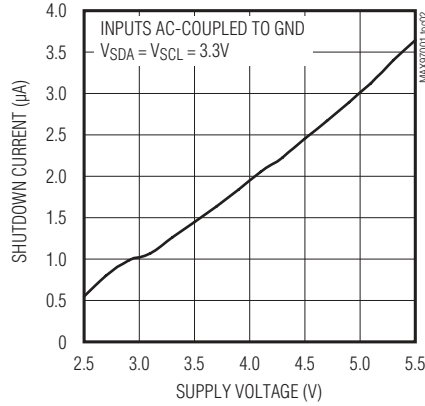

SPEAKER VOLUME ATTENUATION vs. VOLUME CONTROL CODE

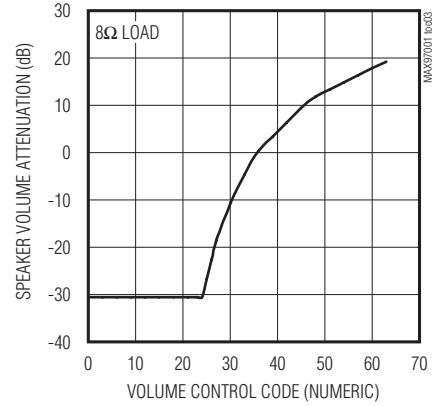

HEADPHONE VOLUME ATTENUATION vs. HP_VOL CODE

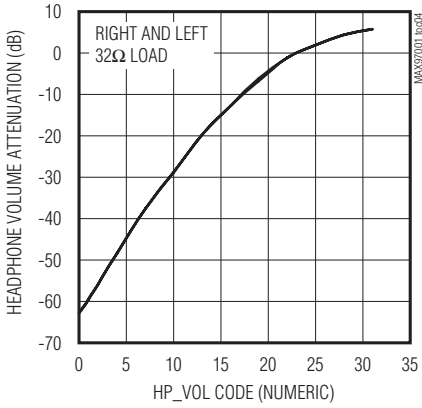

THD+N vs. FREQUENCY

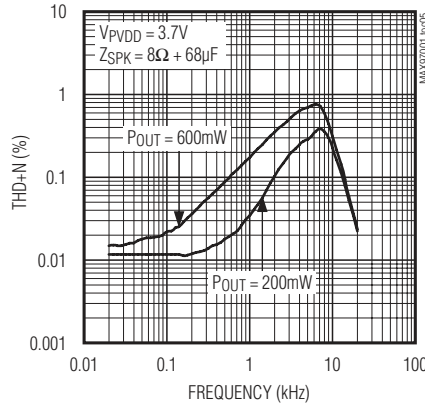

THD+N vs. FREQUENCY

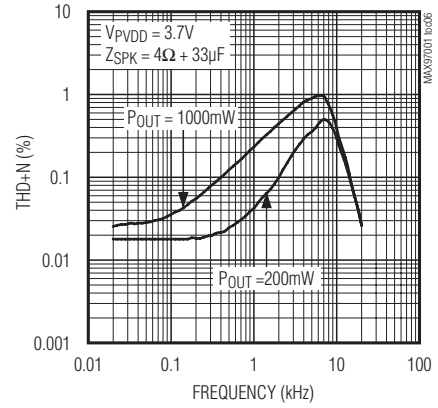

THD+N vs. FREQUENCY

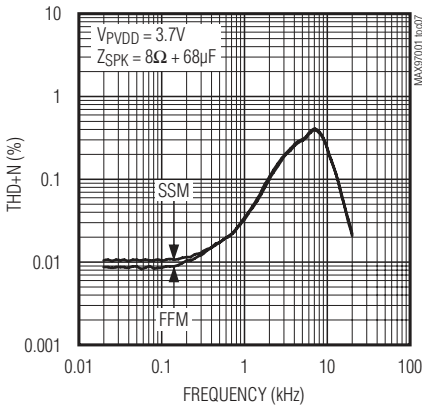

THD+N vs. OUTPUT POWER

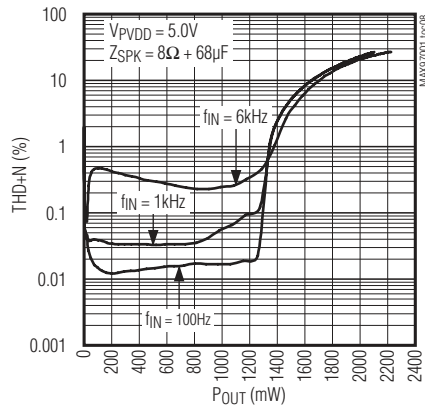

THD+N vs. OUTPUT POWER

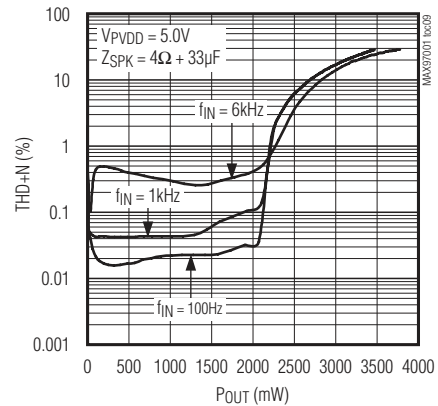

Audio Subsystem with Mono Class D Speaker and Class H Headphone Amplifiers

Typical Operating Characteristics (continued)

($V_{LDOIN} = V_{PVDD} = 3.7V$, $V_{GND} = V_{PGND} = 0V$. Single-ended inputs, preamp gain = 0dB, HPLVOL = HPRVOL = SPKVOL = 0dB. Speaker loads (Z_{SPK}) connected between OUTP and OUTN. Headphone loads (R_{HP}) connected from HPL or HPR to GND. $Z_{SPK} = \infty$, $R_{HP} = \infty$. $CC1P-C1N = CHPVDD = CHPVSS = CBIAS = 1\mu F$. $T_A = +25^\circ C$, unless otherwise noted.)

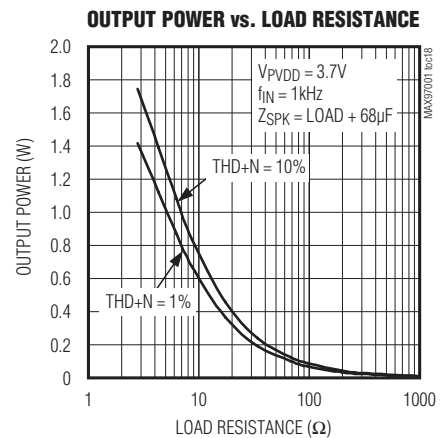
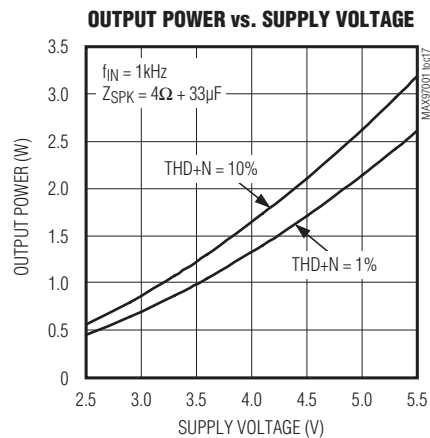
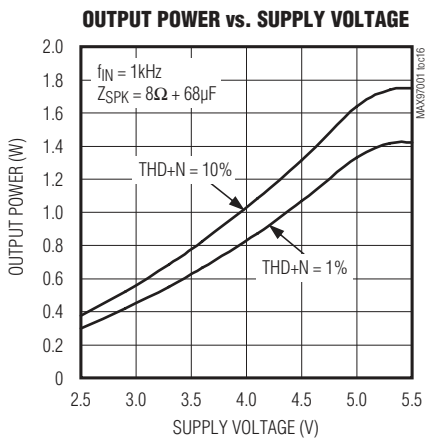
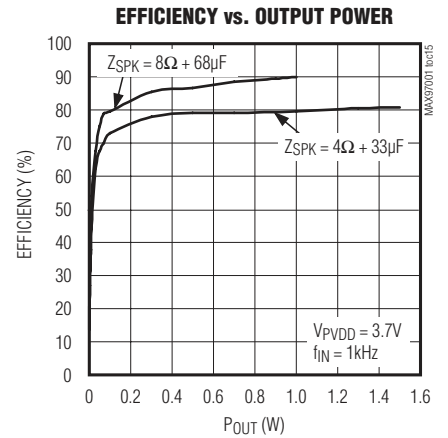
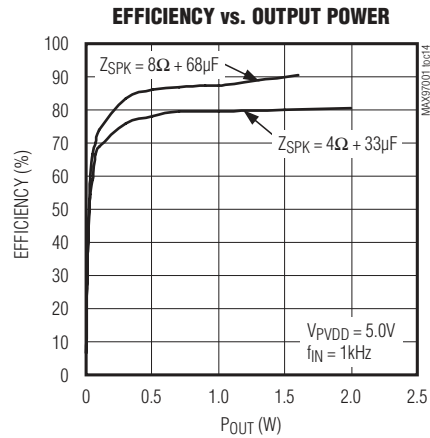
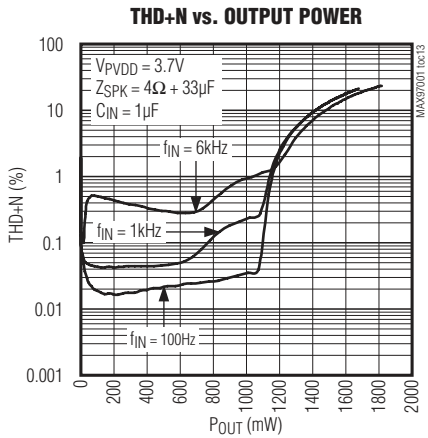
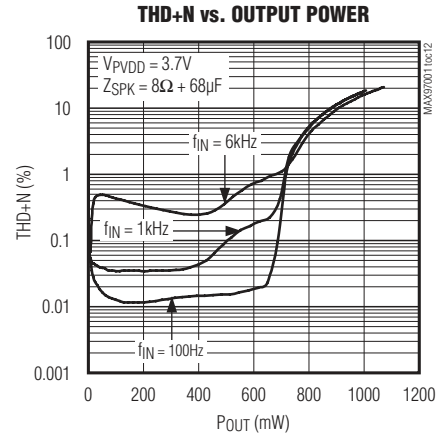
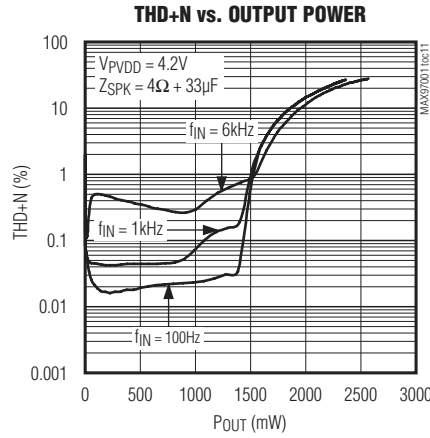
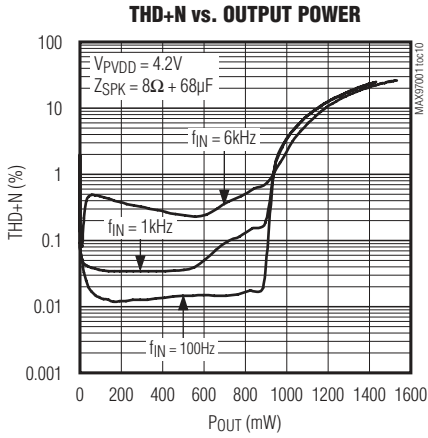

Audio Subsystem with Mono Class D Speaker and Class H Headphone Amplifiers

MAX97001

Typical Operating Characteristics (continued)

($V_{LDIOIN} = V_{PVDD} = 3.7V$, $V_{GND} = V_{PGND} = 0V$. Single-ended inputs, preamp gain = 0dB, HPLVOL = HPRVOL = SPKVOL = 0dB. Speaker loads (Z_{SPK}) connected between OUTP and OUTN. Headphone loads (R_{HP}) connected from HPL or HPR to GND. $Z_{SPK} = \infty$, $R_{HP} = \infty$. CC1P-C1N = CHPVDD = CHPVSS = CBIAS = 1 μ F. $T_A = +25^\circ C$, unless otherwise noted.)

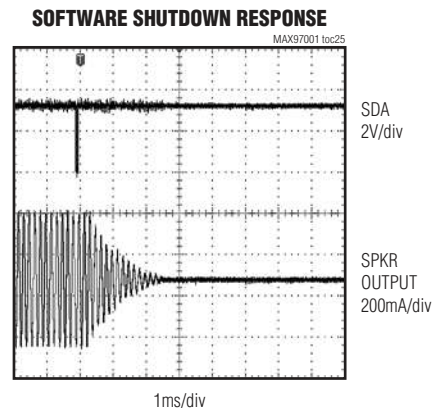
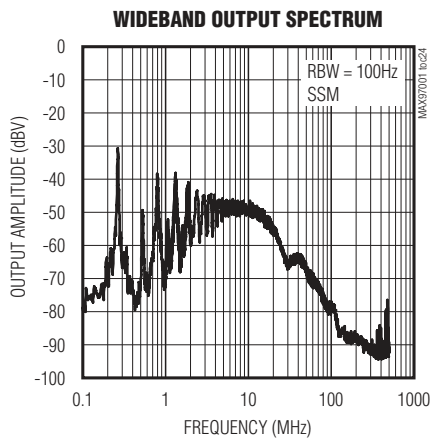
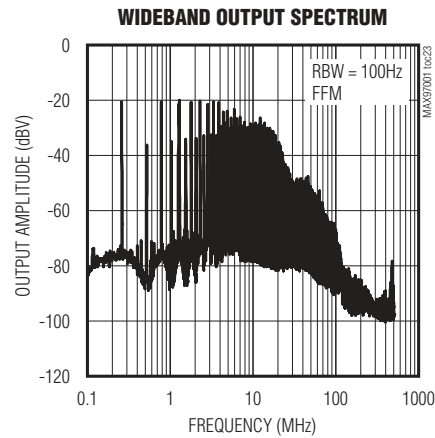
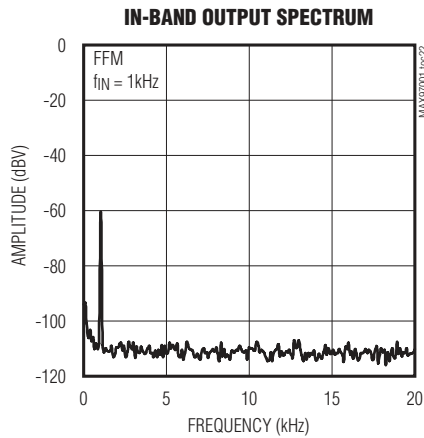
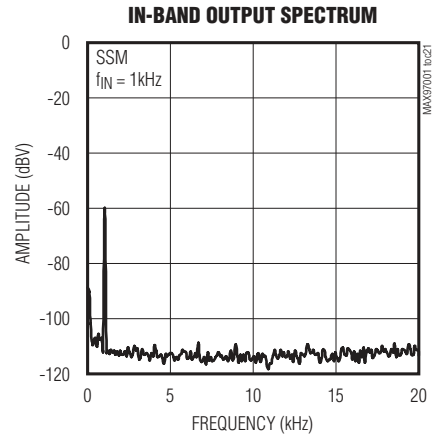
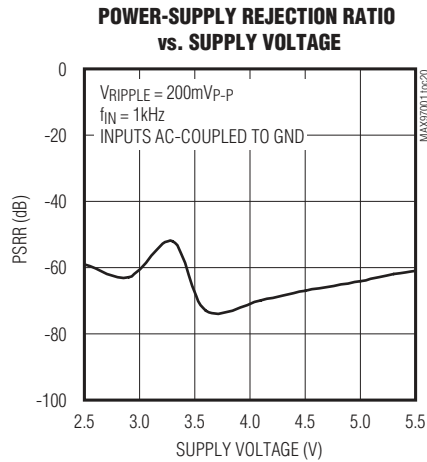
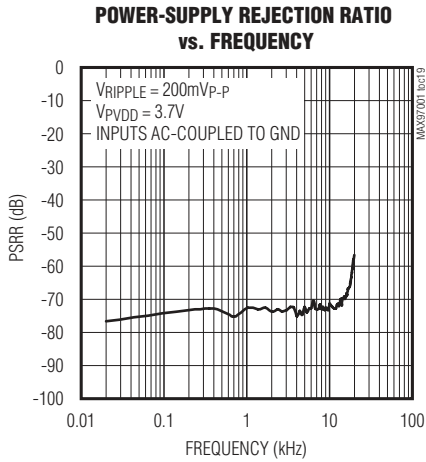

Audio Subsystem with Mono Class D Speaker and Class H Headphone Amplifiers

Typical Operating Characteristics (continued)

(VLDIOIN = VPVDD = 3.7V, VGND = VPGND = 0V. Single-ended inputs, preamp gain = 0dB, HPLVOL = HPRVOL = SPKVOL = 0dB. Speaker loads (Z_{SPK}) connected between OUTP and OUTN. Headphone loads (R_{HPL}) connected from HPL or HPR to GND. Z_{SPK} = ∞, R_{HPL} = ∞. CC1P-C1N = CHPVDD = CHPVSS = CBIAS = 1μF. T_A = +25°C, unless otherwise noted.)

SOFTWARE TURN-ON RESPONSE

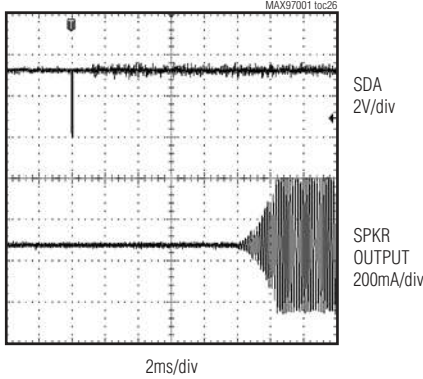

THD+N vs. FREQUENCY

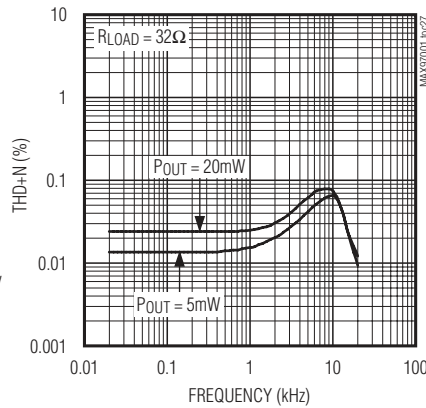

THD+N vs. FREQUENCY

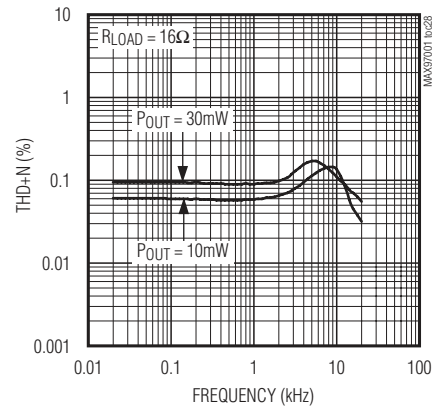

THD+N vs. OUTPUT POWER

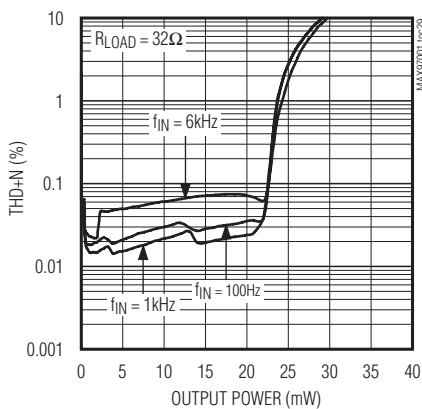

THD+N vs. OUTPUT POWER

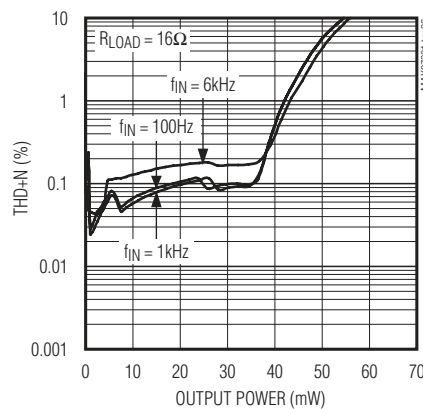

POWER DISSIPATION vs. OUTPUT POWER

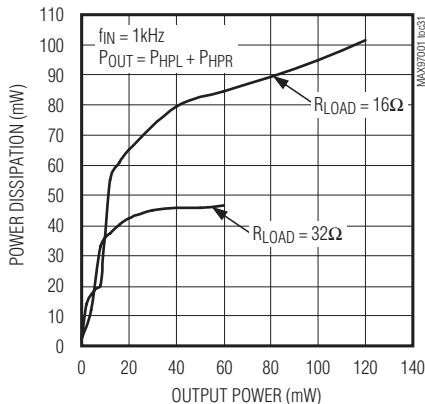

OUTPUT POWER vs. LOAD RESISTANCE

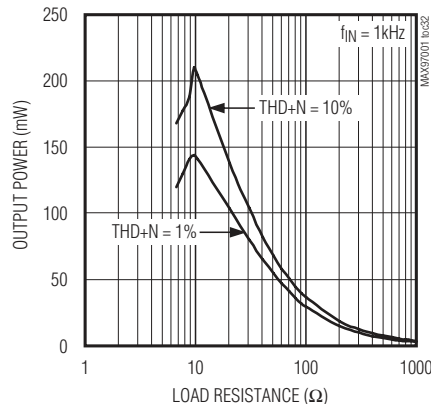

Audio Subsystem with Mono Class D Speaker and Class H Headphone Amplifiers

MAX97001

Typical Operating Characteristics (continued)

($V_{LDOIN} = V_{PDD} = 3.7V$, $V_{GND} = V_{PND} = 0V$. Single-ended inputs, preamp gain = 0dB, HPLVOL = HPRVOL = SPKVOL = 0dB. Speaker loads (Z_{SPK}) connected between OUTP and OUTN. Headphone loads (R_{HP}) connected from HPL or HPR to GND. $Z_{SPK} = \infty$, $R_{HP} = \infty$. $C_{C1P-C1N} = C_{HPVDD} = C_{HPVSS} = C_{BIAS} = 1\mu F$. $T_A = +25^\circ C$, unless otherwise noted.)

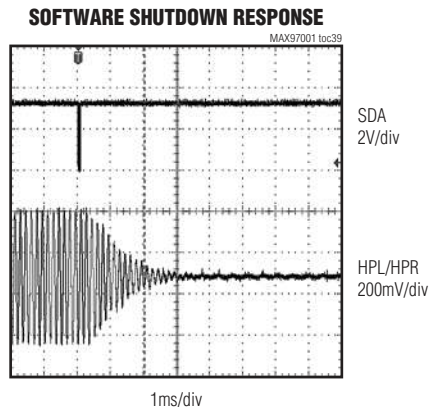
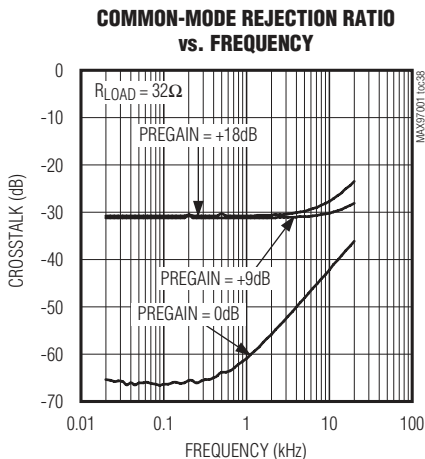
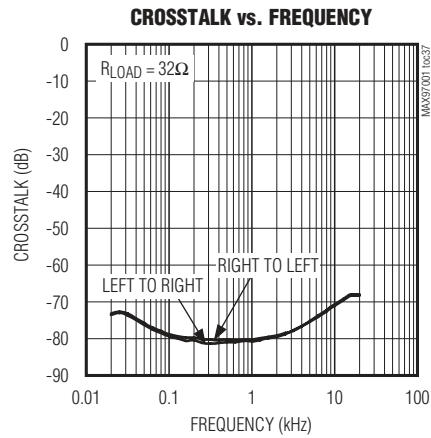
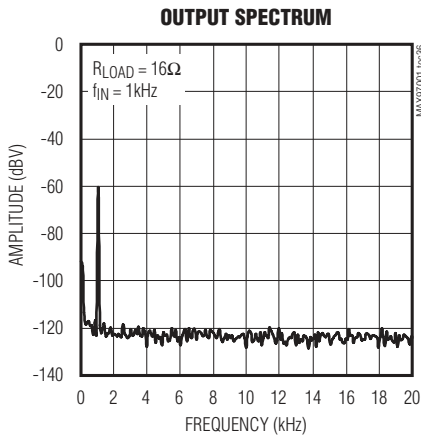
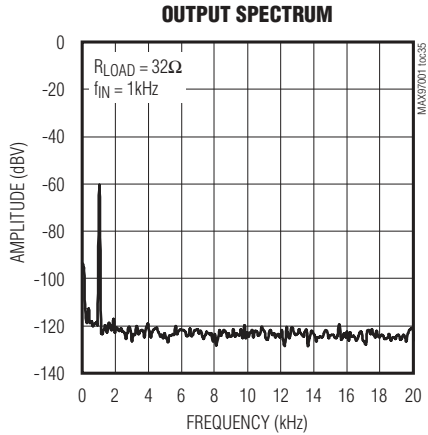
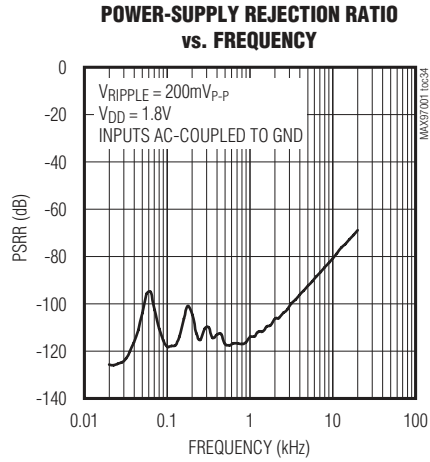
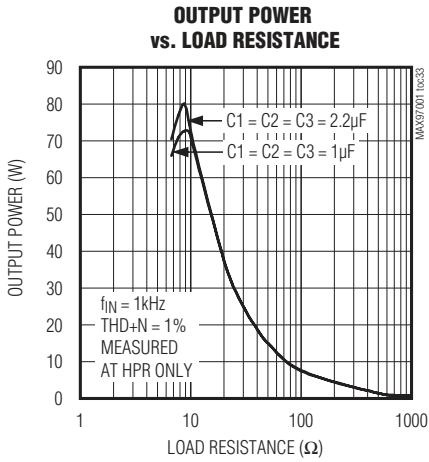

Audio Subsystem with Mono Class D Speaker and Class H Headphone Amplifiers

Typical Operating Characteristics (continued)

(VLDOIN = VPVDD = 3.7V, VGND = VPGND = 0V. Single-ended inputs, preamp gain = 0dB, HPLVOL = HPRVOL = SPKVOL = 0dB. Speaker loads (Z_{SPK}) connected between OUTP and OUTN. Headphone loads (R_{HP}) connected from HPL or HPR to GND. $Z_{SPK} = \infty$, $R_{HP} = \infty$. CC1P-C1N = CHPVDD = CHPVSS = CBIAS = 1 μ F. $T_A = +25^\circ\text{C}$, unless otherwise noted.)

SOFTWARE STARTUP RESPONSE

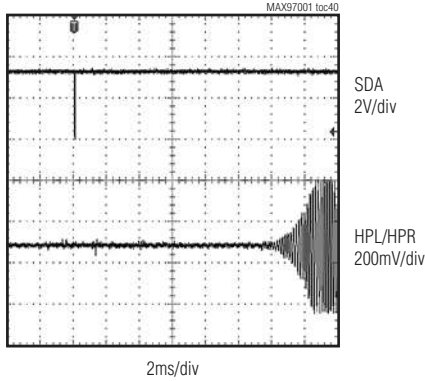

CLASS H OPERATION

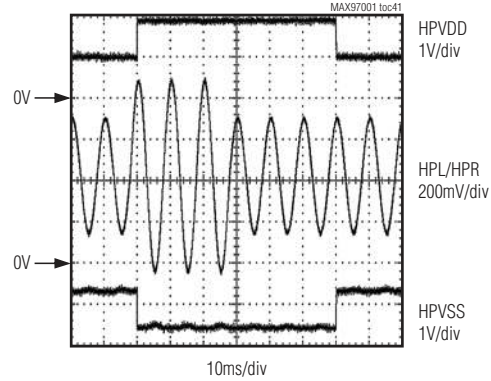

THD+N vs. OUTPUT POWER

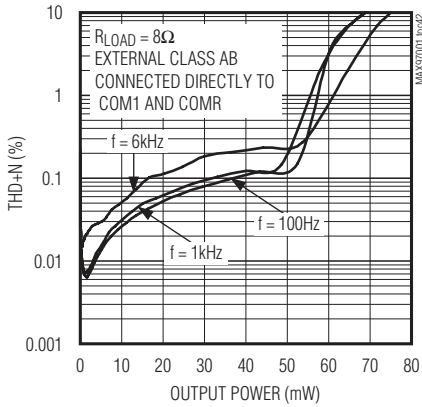

ON-RESISTANCE vs. V_{COM}

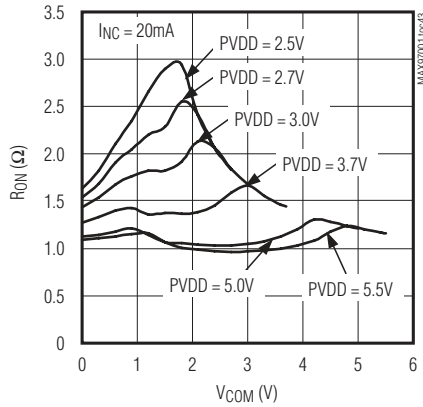

BYPASS SWITCH OFF-ISOLATION

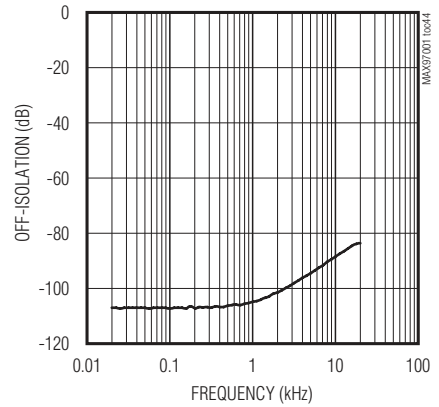

Audio Subsystem with Mono Class D Speaker and Class H Headphone Amplifiers

Pin Configuration

MAX97001

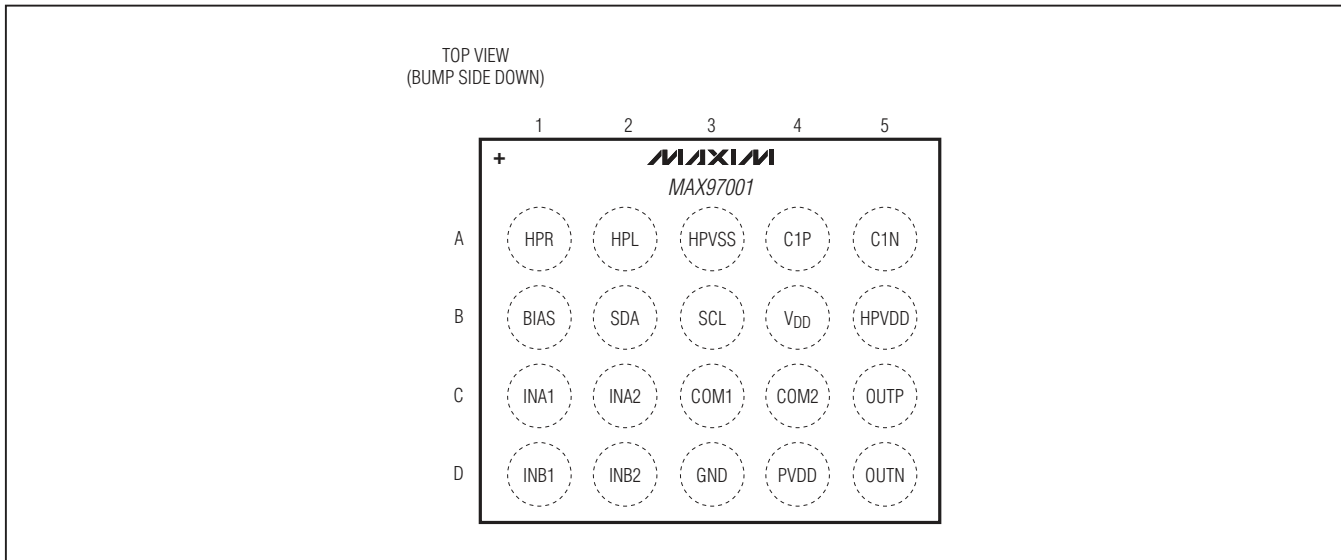

Pin Description

| PIN | NAME | FUNCTION |
|-----|-----------------|--|
| A1 | HPR | Headphone Amplifier Left Output |
| A2 | HPL | Headphone Amplifier Right Output |
| A3 | HPVSS | Headphone Amplifier Negative Power Supply. Bypass with a 1 μ F capacitor to GND. |
| A4 | C1P | Charge-Pump Flying Capacitor Positive Terminal. Connect a 1 μ F capacitor between C1P and C1N. |
| A5 | C1N | Charge-Pump Flying Capacitor Negative Terminal. Connect a 1 μ F capacitor between C1P and C1N. |
| B1 | BIAS | Common-Mode Bias. Bypass to GND with a 1 μ F capacitor. |
| B2 | SDA | Serial-Data Input/Output. Connect a pullup resistor from SDA to DVDD. |
| B3 | SCL | Serial-Clock Input. Connect a pullup resistor from SCL to DVDD. |
| B4 | V _{DD} | Headphone Amplifier Supply. Bypass with a 1 μ F capacitor to GND. |
| B5 | HPVDD | Headphone Amplifier Positive Power Supply. Bypass with a 1 μ F capacitor to GND. |
| C1 | INA1 | Input A1. Left input or negative input. |
| C2 | INA2 | Input A2. Right input or positive input. |
| C3 | COM1 | Positive Bypass Switch Input |
| C4 | COM2 | Negative Bypass Switch Input |
| C5 | OUTP | Positive Speaker Output |
| D1 | INB1 | Input B1. Left input or negative input. |
| D2 | INB2 | Input B2. Right input or positive input. |
| D3 | GND | Analog Ground |
| D4 | PVDD | Class D Power Supply. Bypass with a 1 μ F capacitor to GND. |
| D5 | OUTN | Negative Speaker Output |

Audio Subsystem with Mono Class D Speaker and Class H Headphone Amplifiers

Detailed Description

The MAX97001 mono audio subsystem combines a mono speaker amplifier with a stereo headphone amplifier and an analog DPST switch. The high-efficiency, 700mW, Class D speaker amplifier operates directly from the battery and consumes no more than 1 μ A when in shutdown mode. The headphone amplifier utilizes a dual-mode charge pump and a Class H output stage to maximize efficiency while outputting a ground-referenced signal that does not require output-coupling capacitors. The headphone and speaker amplifiers have independent volume control and on/off control. The 4 inputs are configurable as 2 differential inputs or 4 single-ended inputs. All control is performed using the 2-wire I²C interface.

The speaker amplifier incorporates a distortion limiter to automatically reduce the volume level when excessive clipping occurs. This allows high gain for low-level signals without compromising the quality of large signals.

Signal Path

The MAX97001 signal path consists of flexible inputs, signal mixing, volume control, and output amplifiers

(Figure 2). The inputs can be configured for single-ended or differential signals (Figure 3). The internal preamplifiers feature programmable gain settings using internal resistors and an external gain setting using a trimmed internal feedback resistor. The external option allows any desired gain to be selected. Following pre-amplification, the input signals are mixed, volume adjusted, and routed to the headphone and speaker amplifiers based on the desired configuration.

Mixers

The MAX97001 features independent mixers for the left headphone, right headphone, and speaker paths. Each output can select any combination of any inputs. This allows for mixing two audio signals together and routing independent signals to the headphone and speaker amplifiers. If one of the inputs is not selected by either mixer, it is automatically powered down to save power.

Class D Speaker Amplifier

The MAX97001 Class D speaker amplifier utilizes active emissions limiting and spread-spectrum modulation to minimize the EMI radiated by the amplifier.

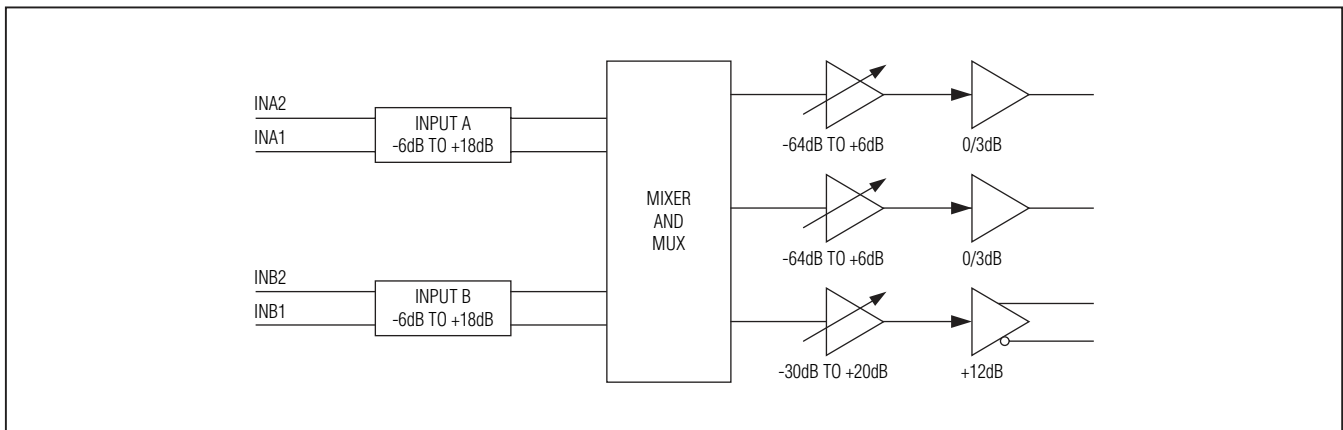

Figure 2. Signal Path

Audio Subsystem with Mono Class D Speaker and Class H Headphone Amplifiers

MAX97001

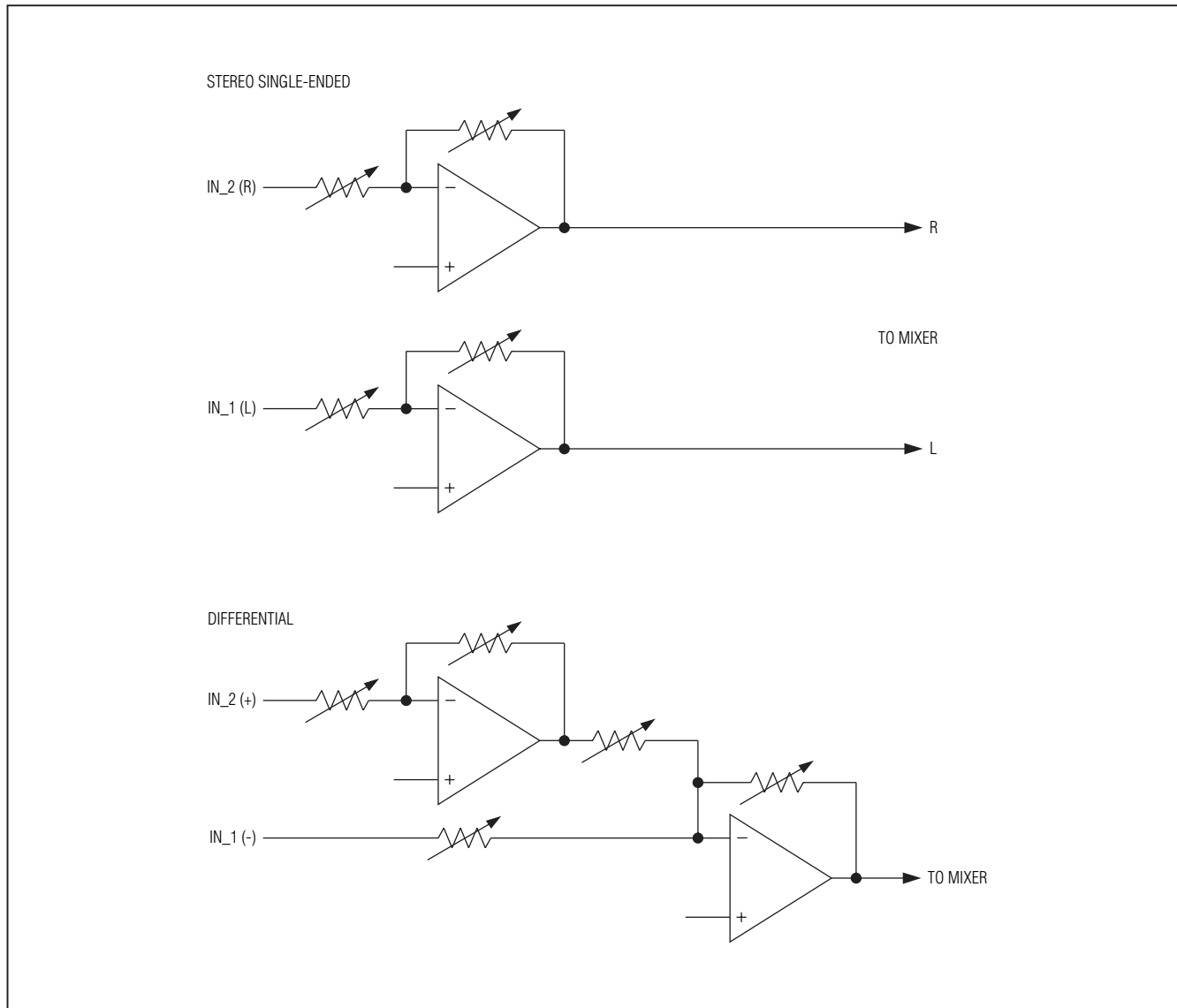

Figure 3. Differential and Stereo Single-Ended Input Configurations

Audio Subsystem with Mono Class D Speaker and Class H Headphone Amplifiers

Ultra-Low EMI Filterless Output Stage

Traditional Class D amplifiers require the use of external LC filters or shielding in order to meet EN55022B electromagnetic-interference (EMI) regulation standards. Maxim's active emissions limiting edge-rate control circuitry and spread-spectrum modulation reduces EMI emissions, while maintaining up to 87% efficiency. Maxim's spread-spectrum modulation

mode flattens wideband spectral components, while proprietary techniques ensure that the cycle-to-cycle variation of the switching period does not degrade audio reproduction or efficiency. The MAX97001's spread-spectrum modulator randomly varies the switching frequency by $\pm 20\text{kHz}$ around the center frequency (250kHz). Above 10MHz, the wideband spectrum looks like noise for EMI purposes (see Figure 4).

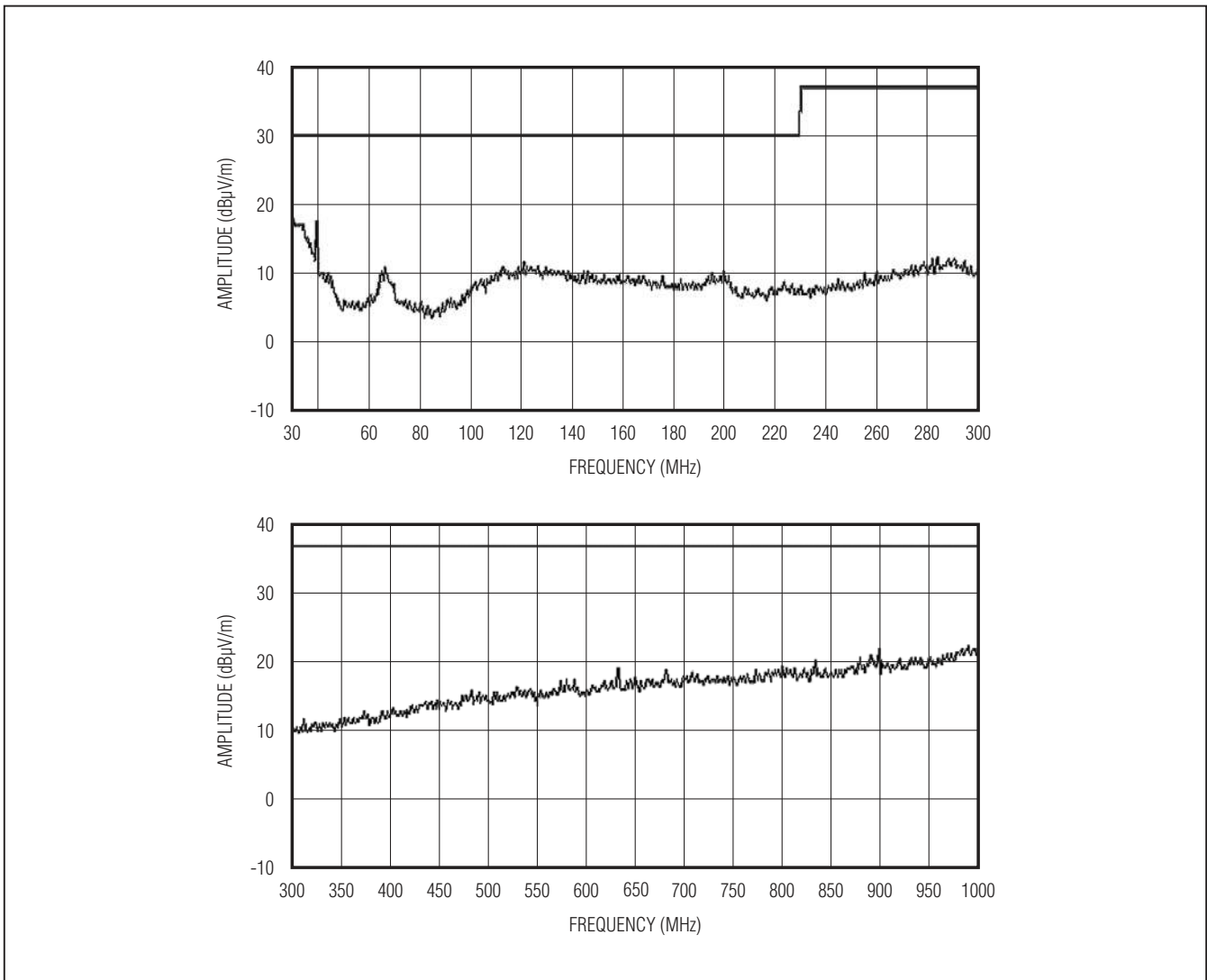

Figure 4. EMI with 15cm of Speaker Cable

Audio Subsystem with Mono Class D Speaker and Class H Headphone Amplifiers

Distortion Limiter

The MAX97001 speaker amplifiers integrate a limiter to provide speaker protection and audio compression. When enabled, the limiter monitors the audio signal at the output of the Class D speaker amplifier and decreases the gain if the distortion exceeds the predefined threshold. The limiter automatically tracks the battery voltage to reduce the gain as the battery voltage drops.

Figure 5 shows the typical output vs. input curves with and without the distortion limiter. The dotted line shows the maximum gain for a given distortion limit without the distortion limiter. The solid line shows how, with the distortion limiter enabled, the gain can be increased without exceeding the set distortion limit. When the limiter is enabled, selecting a high gain level results in peak signals being attenuated while low signals are left unchanged. This increases the perceived loudness without the harshness of a clipped waveform.

Analog Switch

The MAX97001 integrates a DPST analog audio switch that connects COM1 and COM2 to OUTP and OUTN, respectively. Unlike discrete solutions, the switch design reduces coupling of Class D switching noise to the COM_ inputs. This eliminates the need for a costly T-switch. Drive COM1 and COM2 with a low-impedance source to minimize noise on the pins. In applications that do not require the analog switch, leave COM1 and COM2 unconnected. When applying signal on COM1 and COM2, disable the Class D amplifier before closing the switch.

Headphone Amplifier DirectDrive

Traditional single-supply headphone amplifiers have outputs biased at a nominal DC voltage (typically half the supply). Large coupling capacitors are needed to block this DC bias from the headphone. Without these capacitors, a significant amount of DC current flows to the headphone, resulting in unnecessary power dissipation and possible damage to both headphone and headphone amplifier.

Maxim's DirectDrive® architecture uses a charge pump to create an internal negative supply voltage. This allows the headphone outputs of the MAX97001 to be biased at GND while operating from a single supply (Figure 6). Without a DC component, there is no need for the large DC-blocking capacitors. Instead of two large (220 μ F, typ) capacitors, the MAX97001 charge pump requires two small ceramic capacitors, conserving board space, reducing cost, and improving the frequency response of the headphone amplifier. See the Output Power

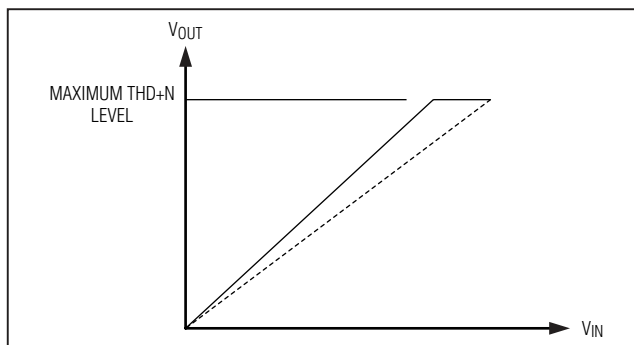

Figure 5. Limiter Gain Curve

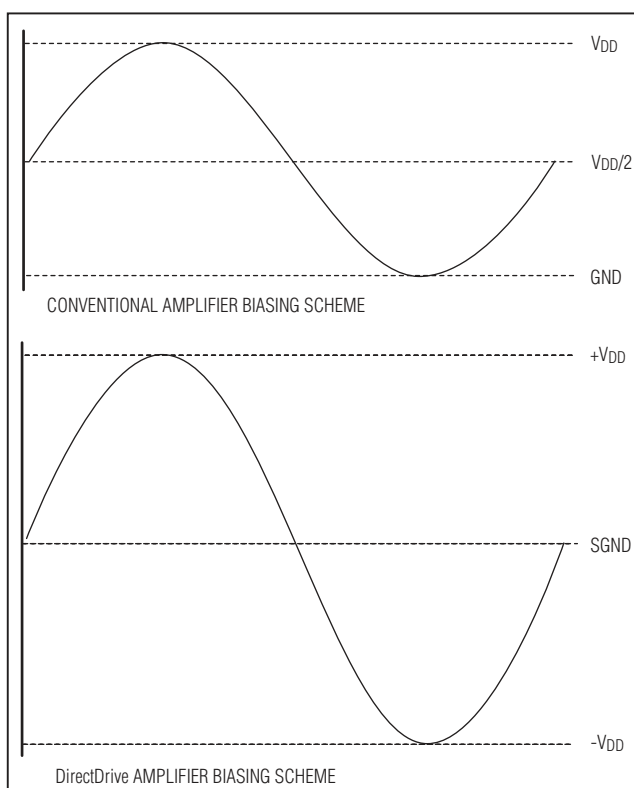

Figure 6. Traditional Amplifier Output vs. MAX97001 DirectDrive Output

vs. Load Resistance graph in the *Typical Operating Characteristics* for details of the possible capacitor sizes. There is a low DC voltage on the amplifier outputs due to amplifier offset. However, the offset of the MAX97001 is typically $\pm 0.6\text{mV}$, which, when combined with a 32Ω load, results in less than $50\mu\text{A}$ of DC current flow to the headphones.

DirectDrive is a registered trademark of Maxim Integrated Products, Inc.

Audio Subsystem with Mono Class D Speaker and Class H Headphone Amplifiers

In addition to the cost and size disadvantages of the DC-blocking capacitors required by conventional headphone amplifiers, these capacitors limit the amplifier's low-frequency response and can distort the audio signal. Previous attempts at eliminating the output-coupling capacitors involved biasing the headphone return (sleeve) to the DC-bias voltage of the headphone amplifiers. This method raises some issues:

- The sleeve is typically grounded to the chassis. Using the midrail biasing approach, the sleeve must be isolated from system ground, complicating product design.
- During an ESD strike, the amplifier's ESD structures are the only path to system ground. Thus, the amplifier must be able to withstand the full energy from an ESD strike.
- When using the headphone jack as a line out to other equipment, the bias voltage on the sleeve may conflict with the ground potential from other equipment, resulting in possible damage to the amplifiers.

Charge Pump

The MAX97001's dual-mode charge pump generates both the positive and negative power supply for the headphone amplifier. To maximize efficiency, both the charge pump's switching frequency and output voltage change based on signal level.

When the input signal level is less than 10% of V_{DD} the switching frequency is reduced to a low rate. This minimizes switching losses in the charge pump. When the input signal exceeds 10% of V_{DD} , the switching frequency increases to support the load current.

For input signals below 25% of V_{DD} , the charge pump generates $\pm(V_{DD}/2)$ to minimize the voltage drop across the amplifier's power stage and thus improves efficiency. Input signals that exceed 25% of V_{DD} cause the charge pump to output $\pm V_{DD}$. The higher output voltage allows for full output power from the headphone amplifier.

To prevent audible glitches when transitioning from the $\pm(V_{DD}/2)$ output mode to the $\pm V_{DD}$ output mode, the charge pump transitions very quickly. This quick change draws significant current from V_{DD} for the duration of the transition. The bypass capacitor on V_{DD} supplies the required current and prevent droop on V_{DD} .

The charge pump's dynamic switching mode can be turned off through the I²C interface. The charge pump can then be forced to output either $\pm(V_{DD}/2)$ or $\pm V_{DD}$ regardless of input signal level.

Class H Operation

A Class H amplifier uses a Class AB output stage with power supplies that are modulated by the output signal. In the case of the MAX97001, two nominal power-supply differentials of 1.8V (+0.9V to -0.9V) and 3.6V (+1.8V to -1.8V) are available from the charge pump. Figure 7 shows the operation of the output voltage dependent power supply.

Low-Power Mode

To minimize power consumption when using the headphone amplifier, enable the low-power mode. In this mode, the headphone mixers and volume control are bypassed and shutdown.

I²C Slave Address

The MAX97001 uses a slave address of 0x9A or 1001101R/W. The address is defined as the 7 most significant bits (MSBs) followed by the read/write bit. Set the read/write bit to 1 to configure the MAX97001 to read mode. Set the read/write bit to 0 to configure the MAX97001 to write mode. The address is the first byte of information sent to the MAX97001 after the START (S) condition.

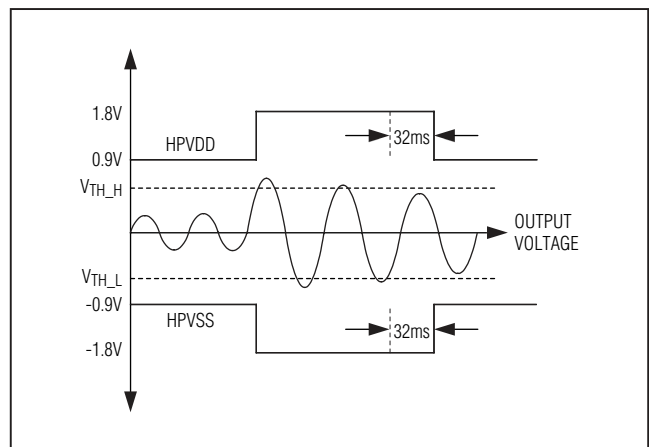

Figure 7. Class H Operation

Audio Subsystem with Mono Class D Speaker and Class H Headphone Amplifiers

MAX97001

I²C Registers

Nine internal registers program the MAX97001. Table 1 lists all of the registers, their addresses, and power-on-reset states. Register 0xFF indicates the device revision.

Write zeros to all unused bits in the register table when updating the register, unless otherwise noted. Tables 2–7 describe each bit.

Table 1. Register Map

| REGISTER | B7 | B6 | B5 | B4 | B3 | B2 | B1 | B0 | ADDRESS | DEFAULT | R/W |
|--------------------|--------------------------|--------------------------|--------|--------|--------|-------|-------|-------|---------|---------|-----|
| STATUS | | | | | | | | | | | |
| Input Gain | INADIFF | INBDIFF | PGAINA | | PGAINB | | | | 0x00 | 0x00 | R/W |
| Headphone Mixers | HPLMIX | | | HPRMIX | | | | | 0x01 | 0x00 | R/W |
| Speaker Mixer | 0 | 0 | 0 | 0 | SPKMIX | | | | 0x02 | 0x00 | R/W |
| Headphone Left | $\overline{\text{ZCD}}$ | $\overline{\text{SLEW}}$ | HPLM | HPLVOL | | | | | 0x03 | 0x00 | R/W |
| Headphone Right | HPGAIN | 0 | HPRM | HPRVOL | | | | | 0x04 | 0x00 | R/W |
| Speaker | FFM | SPKM | SPKVOL | | | | | | 0x05 | 0x00 | R/W |
| Reserved | 0 | 0 | 0 | 0 | 0 | 0 | 0 | 0 | 0x06 | 0x00 | R/W |
| Limiters | THDCLP | | | | 0 | 0 | 0 | THDT1 | 0x07 | 0x00 | R/W |
| Power Management | $\overline{\text{SHDN}}$ | LPMODE | | SPKEN | 0 | HPLEN | HPREN | BYPEN | 0x08 | 0x01 | R/W |
| Charge Pump | 0 | 0 | 0 | 0 | 0 | 0 | CPSEL | FIXED | 0x09 | 0x00 | R/W |
| REVISION ID | | | | | | | | | | | |
| Rev ID | REV | | | | | | | | 0xFF | 0x00 | R |

Audio Subsystem with Mono Class D Speaker and Class H Headphone Amplifiers

Table 2. Input Register

| REGISTER | BIT | NAME | DESCRIPTION | |
|----------|--------|--|--|-------------------|
| 0x00 | 7 | INADIFF | Input A Differential Mode. Configures the input A channel as either a mono differential signal ($INA = INA2 - INA1$) or as a stereo signal ($INA1 = \text{left}$, $INA2 = \text{right}$). 0 = Stereo single-ended 1 = Differential | |
| | 6 | INBDIFF | Input B Differential Mode. Configures the input B channel as either a mono differential signal ($INB = INB2 - INB1$) or as a stereo signal ($INB1 = \text{left}$, $INB2 = \text{right}$). 0 = Stereo single-ended 1 = Differential | |
| | 5 | PGAINA | Input A Preamp Gain. Set the input gain to maximize output signal level for a given input signal range to improve the SNR of the system. PGAINA = 111 switches to a trimmed 20k Ω feedback resistor for external gain setting. | |
| | 4 | | VALUE | LEVEL (dB) |
| | | | 000 | -6 |
| | | | 001 | -3 |
| | | | 010 | 0 |
| | 3 | | 011 | 3dB |
| | | | 100 | 6 |
| | | | 101 | 9 |
| | | 110 | 18 | |
| | | 111 | External | |
| 2 | PGAINB | Input B Preamp Gain. Set the input gain to maximize output signal level for a given input signal range to improve the SNR of the system. PGAINB = 111 switches to a trimmed 20k Ω feedback resistor for external gain setting. | | |
| 1 | | VALUE | LEVEL (dB) | |
| | | 000 | -6 | |
| | | 001 | -3 | |
| | | 010 | 0 | |
| 0 | | 011 | 3 | |
| | | 100 | 6 | |
| | | 101 | 9 | |
| | | 110 | 18 | |
| | | 111 | External | |

Audio Subsystem with Mono Class D Speaker and Class H Headphone Amplifiers

Mixers

MAX97001

Table 3. Mixer Registers

| REGISTER | BIT | NAME | DESCRIPTION | |
|----------|-----|--------|---|--|
| 0x01 | 7 | HPLMIX | Left Headphone Mixer. Selects which of the four inputs is routed to the left headphone output. | |
| | 6 | | VALUE | INPUT |
| | 5 | | 0000 | No input |
| | 4 | | xxx1 xx1x x1xx 1xxx | INA1 (disabled when INADIFF = 1) INA2 (select when INADIFF = 1) INB1 (disabled when INBDIFF = 1) INB2 (select when INBDIFF = 1) |
| | 3 | HPRMIX | Right Headphone Mixer. Selects which of the four inputs is routed to the right headphone output. | |
| | 2 | | VALUE | INPUT |
| | 1 | | 0000 | No input |
| | 0 | | xxx1 xx1x x1xx 1xxx | INA1 (disabled when INADIFF = 1) INA2 (select when INADIFF = 1) INB1 (disabled when INBDIFF = 1) INB2 (select when INBDIFF = 1) |
| 0x02 | 3 | SPKMIX | Speaker Mixer. Selects which of the four inputs is routed to the speaker output. | |
| | 2 | | VALUE | INPUT |
| | 1 | | 0000 | No input |
| | 0 | | xxx1 xx1x x1xx 1xxx | INA1 (disabled when INADIFF = 1) INA2 (select when INADIFF = 1) INB1 (disabled when INBDIFF = 1) INB2 (select when INBDIFF = 1) |

Audio Subsystem with Mono Class D Speaker and Class H Headphone Amplifiers

Volume Control

Table 4. Volume Control Registers

| REGISTER | BIT | NAME | DESCRIPTION | | | |
|----------|-----|--------------------------|--|-------------------|--------------|-------------------|
| 0x03 | 7 | $\overline{\text{ZCD}}$ | Zero-Crossing Detection. Determines whether zero-crossing detection is used on all volume control changes to reduce clicks and pops. Disabling zero-crossing detection allows volume changes to occur immediately. 0 = Enabled 1 = Disabled | | | |
| | 6 | $\overline{\text{SLEW}}$ | Volume Slewing. Determines whether volume slewing is used on all volume control changes to reduce clicks and pops. When enabled, volume changes cause the MAX97001 to ramp through intermediate volume settings whenever a change to the volume is made. If $\overline{\text{ZCD}} = 1$, slewing occurs at a rate of 0.2ms per step. If $\overline{\text{ZCD}} = 0$, slew time depends on the input signal. Write a 1 to this bit to disable slewing and implement volume changes immediately. This bit also activates soft-start at power-on and soft-stop and power-off. 0 = Enabled 1 = Disabled | | | |
| | 5 | HPLM | Left Headphone Mute 0 = Unmuted 1 = Muted | | | |
| | 4 | HPLVOL | Left Headphone Volume | | | |
| | | | VALUE | LEVEL (dB) | VALUE | LEVEL (dB) |
| | | | 0x00 | -64 | 0x10 | -12 |
| | | | 0x01 | -60 | 0x11 | -10 |
| | | | 0x02 | -56 | 0x12 | -8 |
| | | | 0x03 | -52 | 0x13 | -6 |
| | | | 0x04 | -48 | 0x14 | -4 |
| | | | 0x05 | -44 | 0x15 | -2 |
| | | | 0x06 | -40 | 0x16 | -1 |
| | | | 0x07 | -37 | 0x17 | 0 |
| | | | 0x08 | -34 | 0x18 | 1 |
| | | | 0x09 | -31 | 0x19 | 2 |
| | | | 0x0A | -28 | 0x1A | 3 |
| | | | 0x0B | -25 | 0x1B | 4 |
| | | | 0x0C | -22 | 0x1C | 4.5 |
| | | | 0x0D | -19 | 0x1D | 5 |
| 0x0E | | | -16 | 0x1E | 5.5 | |
| 0x0F | -14 | 0x1F | 6 | | | |

Audio Subsystem with Mono Class D Speaker and Class H Headphone Amplifiers

MAX97001

Table 4. Volume Control Registers (continued)

| REGISTER | BIT | NAME | DESCRIPTION | | | |
|----------|------|--------|---|-------------------|--------------|-------------------|
| 0x04 | 7 | HPGAIN | Headphone Gain. Controls the headphone amplifier gain. 0 = 0dB 1 = 3dB | | | |
| | 5 | HPRM | Right Headphone Mute 0 = Unmuted 1 = Muted | | | |
| | 4 | HPRVOL | Right Headphone Volume | | | |
| | | | VALUE | LEVEL (dB) | VALUE | LEVEL (dB) |
| | | | 0x00 | -64 | 0x10 | -12 |
| | | | 0x01 | -60 | 0x11 | -10 |
| | 3 | | 0x02 | -56 | 0x12 | -8 |
| | | | 0x03 | -52 | 0x13 | -6 |
| | | | 0x04 | -48 | 0x14 | -4 |
| | | | 0x05 | -44 | 0x15 | -2 |
| | 2 | | 0x06 | -40 | 0x16 | -1 |
| | | | 0x07 | -37 | 0x17 | 0 |
| | | | 0x08 | -34 | 0x18 | 1 |
| | | | 0x09 | -31 | 0x19 | 2 |
| | | | 0x0A | -28 | 0x1A | 3 |
| | | | 0x0B | -25 | 0x1B | 4 |
| | | | 0x0C | -22 | 0x1C | 4.5 |
| | | | 0x0D | -19 | 0x1D | 5 |
| | | | 0x0E | -16 | 0x1E | 5.5 |
| 0 | 0x0F | | -14 | 0x1F | 6 | |

Audio Subsystem with Mono Class D Speaker and Class H Headphone Amplifiers

Table 4. Volume Control Registers (continued)

| REGISTER | BIT | NAME | DESCRIPTION | | | | | |
|----------|-----|--------|--|-------------------|--------------|-------------------|--------------|-------------------|
| 0x05 | 7 | FFM | Fixed-Frequency Oscillation. Removes spread spectrum from the Class D oscillator. 0 = Spread-spectrum mode 1 = Fixed-frequency mode | | | | | |
| | 6 | SPKM | Speaker Mute 0 = Unmuted 1 = Mute | | | | | |
| | 5 | SPKVOL | Speaker Volume | | | | | |
| | | | VALUE | LEVEL (dB) | VALUE | LEVEL (dB) | VALUE | LEVEL (dB) |
| | 4 | | 0x00–0x18 | -30 | 0x26 | 3 | 0x34 | 14.5 |
| | | | 0x19 | -26 | 0x27 | 4 | 0x35 | 15 |
| | 3 | | 0x1A | -22 | 0x28 | 5 | 0x36 | 15.5 |
| | | | 0x1B | -18 | 0x29 | 6 | 0x37 | 16 |
| | | | 0x1C | -14 | 0x2A | 7 | 0x38 | 16.5 |
| | 2 | | 0x1D | -12 | 0x2B | 8 | 0x39 | 17 |
| | | | 0x1E | -10 | 0x2C | 9 | 0x3A | 17.5 |
| | | | 0x1F | -8 | 0x2D | 10 | 0x3B | 18 |
| | | | 0x20 | -6 | 0x2E | 11 | 0x3C | 18.5 |
| | 1 | | 0x21 | -4 | 0x2F | 12 | 0x3D | 19 |
| | | | 0x22 | -2 | 0x30 | 12.5 | 0x3E | 19.5 |
| | | | 0x23 | 0 | 0x31 | 13 | 0x3F | 20 |
| | 0 | | 0x24 | 1 | 0x32 | 13.5 | | |
| 0x25 | | | 2 | 0x33 | 14 | | | |

Audio Subsystem with Mono Class D Speaker and Class H Headphone Amplifiers

Distortion Limiter

MAX97001

Table 5. Distortion Limiter Register

| REGISTER | BIT | NAME | DESCRIPTION | |
|----------|-------|---|-------------------------|----------------------|
| 0x07 | 7 | THDCLP | Distortion Limit | |
| | 6 | | VALUE | THD LIMIT (%) |
| | | | 0000 | Disabled |
| | | | 0001–1001 | ≤ 4 |
| | | | 1010 | ≤ 5 |
| | | | 1011 | ≤ 6 |
| | | | 1100 | ≤ 8 |
| | | | 1101 | ≤ 11 |
| | | | 1110 | ≤ 12 |
| | 1111 | ≤ 15 | | |
| 0 | THDT1 | Distortion Release Time Constant 0 = 1.4s 1 = 2.8s | | |

Power Management

Table 6. Power Management Register

| REGISTER | BIT | NAME | DESCRIPTION | |
|----------|-------|--------|---|--|
| 0x08 | 7 | SHDN | Software Shutdown 0 = Device disabled 1 = Device enabled | |
| | 6 | LPMODE | Low-Power Headphone Mode. Enables low-power headphone mode. When activated, this mode directly connects the selected channel to the headphone amplifiers, bypassing the mixers and the volume control. Additionally, low-power mode disables the speaker path. | |
| | 5 | | VALUE | LIMIT |
| | | | 00 | Disabled |
| | | | 01 | INA (SE) Connected to the headphone output |
| | | 10 | INB (SE) Connected to the headphone output | |
| | 4 | SPKEN | Speaker Amplifier Enable 0 = Disabled 1 = Enabled | |
| | | | Left Headphone Amplifier Enable 0 = Disabled 1 = Enabled | |
| | 2 | HPLEN | Right Headphone Amplifier Enable 0 = Disabled 1 = Enabled | |
| | 1 | HPREN | Analog Switch 0 = Open 1 = Closed | |
| 0 | BYPEN | | | |

Audio Subsystem with Mono Class D Speaker and Class H Headphone Amplifiers

Charge-Pump Control

Table 7. Charge-Pump Control Register

| REGISTER | BIT | NAME | DESCRIPTION |
|----------|-----|-------|---|
| 0x09 | 1 | CPSEL | Charge-Pump Output Select. Works with the FIXED to set $\pm 1.8V$ or $\pm 0.9V$ outputs on HPVDD and HPVSS. Ignored when FIXED = 0. 0 = $\pm 1.8V$ on HPVDD/HPVSS 1 = $\pm 0.9V$ on HPVDD/HPVSS |
| | 0 | FIXED | Class H Mode. When enabled, this bit forces the charge pump to generate static power rails for HPVDD and HPVSS, instead of dynamically adjusting them based on output signal level. 0 = Class H mode 1 = Fixed-supply mode |

I²C Serial Interface

The MAX97001 features an I²C/SMBus™-compatible, 2-wire serial interface consisting of a serial-data line (SDA) and a serial-clock line (SCL). SDA and SCL facilitate communication between the MAX97001 and the master at clock rates up to 400kHz. Figure 1 shows the 2-wire interface timing diagram. The master generates SCL and initiates data transfer on the bus. The master device writes data to the MAX97001 by transmitting the proper slave address followed by the register address and then the data word. Each transmit sequence is framed by a START or REPEATED START (Sr) condition and a STOP (P) condition. Each word transmitted to the MAX97001 is 8 bits long and is followed by an acknowledge clock pulse. A master reading data from the MAX97001 transmits the proper slave address followed by a series of nine SCL pulses. The MAX97001 transmits data on SDA in sync with the master-generated SCL pulses. The master acknowledges receipt of each byte of data. Each read sequence is framed by a START or REPEATED START condition, a not acknowledge, and a STOP condition. SDA operates as both an input and an open-drain output. A pullup resistor, typically greater than 500 Ω , is required on SDA. SCL operates only as an input. A pullup resistor, typically greater than 500 Ω , is required on SCL if there are multiple masters on the bus, or if the single master has an open-drain SCL output. Series resistors in line with SDA and SCL are optional. Series resistors protect the digital inputs of the MAX97001 from high-voltage spikes on the bus lines and minimize crosstalk and undershoot of the bus signals.

SMBus is a trademark of Intel Corp.

Bit Transfer

One data bit is transferred during each SCL cycle. The data on SDA must remain stable during the high period of the SCL pulse. Changes in SDA while SCL is high are control signals (see the *START and STOP Conditions* section).

START and STOP Conditions

SDA and SCL idle high when the bus is not in use. A master initiates communication by issuing a START condition. A START condition is a high-to-low transition on SDA with SCL high. A STOP condition is a low-to-high transition on SDA while SCL is high (Figure 8). A START condition from the master signals the beginning of a transmission to the MAX97001. The master terminates transmission, and frees the bus, by issuing a STOP condition. The bus remains active if a REPEATED START condition is generated instead of a STOP condition.

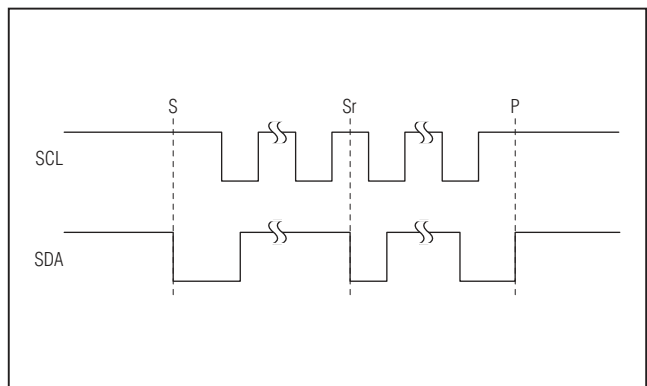

Figure 8. START, STOP, and REPEATED START Conditions

Audio Subsystem with Mono Class D Speaker and Class H Headphone Amplifiers

Early STOP Conditions

The MAX97001 recognizes a STOP condition at any point during data transmission except if the STOP condition occurs in the same high pulse as a START condition. For proper operation, do not send a STOP condition during the same SCL high pulse as the START condition.

Slave Address

The slave address is defined as the seven most significant bits (MSBs) followed by the read/write bit. For the MAX97001 the 7 MSBs are 1001101. Setting the read/write bit to 1 (slave address = 0x9B) configures the MAX97001 for read mode. Setting the read/write bit to 0 (slave address = 0x9A) configures the MAX97001 for write mode. The address is the first byte of information sent to the MAX97001 after the START condition.

Acknowledge

The acknowledge bit (ACK) is a clocked 9th bit that the MAX97001 uses to handshake receipt each byte of data when in write mode (Figure 9). The MAX97001 pulls down SDA during the entire master-generated 9th clock pulse if the previous byte is successfully received. Monitoring ACK allows for detection of unsuccessful data transfers. An unsuccessful data transfer occurs if a receiving device is busy or if a system fault has occurred. In the event of an unsuccessful data transfer, the bus master retries communication. The master pulls down SDA during the 9th clock cycle to acknowledge receipt of data when the MAX97001 is in read mode. An acknowledge is sent by the master after each read byte to allow data transfer to continue. A not-acknowledge is

sent when the master reads the final byte of data from the MAX97001, followed by a STOP condition.

Write Data Format

A write to the MAX97001 includes transmission of a START condition, the slave address with the R/\bar{W} bit set to 0, one byte of data to configure the internal register address pointer, one or more bytes of data, and a STOP condition. Figure 10 illustrates the proper frame format for writing one byte of data to the MAX97001. Figure 11 illustrates the frame format for writing n-bytes of data to the MAX97001.

The slave address with the R/\bar{W} bit set to 0 indicates that the master intends to write data to the MAX97001. The MAX97001 acknowledges receipt of the address byte during the master-generated 9th SCL pulse.

The second byte transmitted from the master configures the MAX97001's internal register address pointer. The pointer tells the MAX97001 where to write the next byte of data. An acknowledge pulse is sent by the MAX97001 upon receipt of the address pointer data.

The third byte sent to the MAX97001 contains the data that is written to the chosen register. An acknowledge pulse from the MAX97001 signals receipt of the data byte. The address pointer autoincrements to the next register address after each received data byte. This autoincrement feature allows a master to write to sequential registers within one continuous frame. The master signals the end of transmission by issuing a STOP condition. Register addresses greater than 0x09 are reserved. Do not write to these addresses.

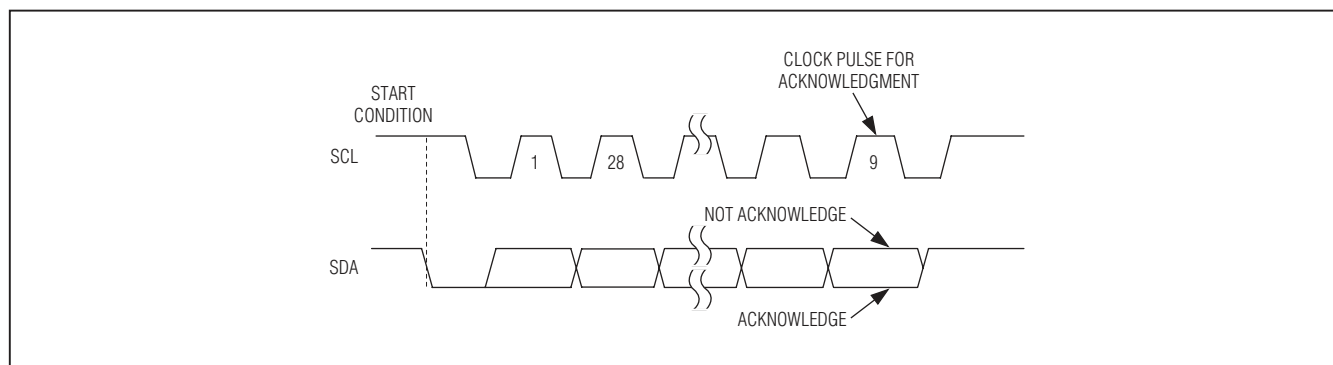

Figure 9. Acknowledge

Audio Subsystem with Mono Class D Speaker and Class H Headphone Amplifiers

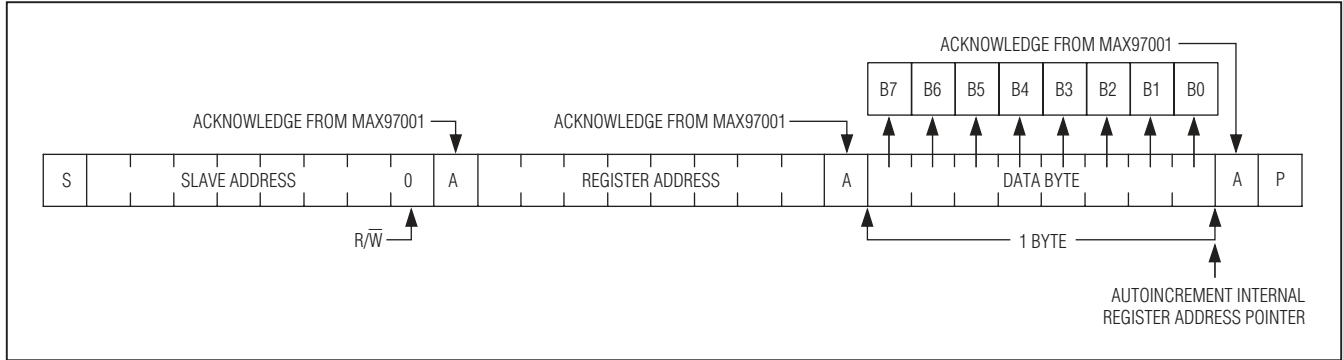

Figure 10. Writing One Byte of Data to the MAX97001

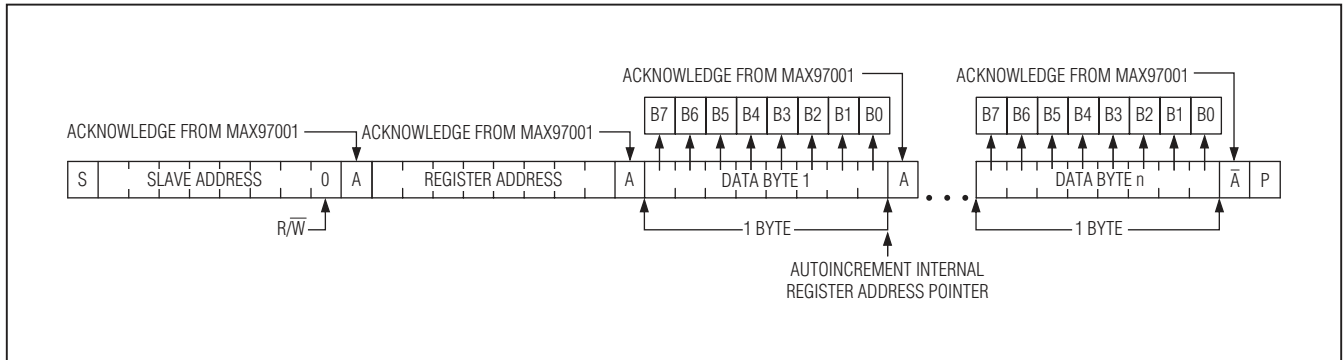

Figure 11. Writing n-Bytes of Data to the MAX97001

Read Data Format

Send the slave address with the R/\bar{W} bit set to 1 to initiate a read operation. The MAX97001 acknowledges receipt of its slave address by pulling SDA low during the 9th SCL clock pulse. A START command followed by a read command resets the address pointer to register 0x00.

The first byte transmitted from the MAX97001 is the contents of register 0x00. Transmitted data is valid on the rising edge of SCL. The address pointer autoincrements after each read data byte. This autoincrement feature allows all registers to be read sequentially within one continuous frame. A STOP condition can be issued after any number of read data bytes. If a STOP condition is issued followed by another read operation, the first data byte to be read is from register 0x00.

The address pointer can be preset to a specific register before a read command is issued. The master presets

the address pointer by first sending the MAX97001's slave address with the R/\bar{W} bit set to 0 followed by the register address. A REPEATED START condition is then sent followed by the slave address with the R/\bar{W} bit set to 1. The MAX97001 then transmits the contents of the specified register. The address pointer autoincrements after transmitting the first byte.

The master acknowledges receipt of each read byte during the acknowledge clock pulse. The master must acknowledge all correctly received bytes except the last byte. The final byte must be followed by a not acknowledge from the master and then a STOP condition. Figure 12 illustrates the frame format for reading one byte from the MAX97001. Figure 13 illustrates the frame format for reading multiple bytes from the MAX97001.

Audio Subsystem with Mono Class D Speaker and Class H Headphone Amplifiers

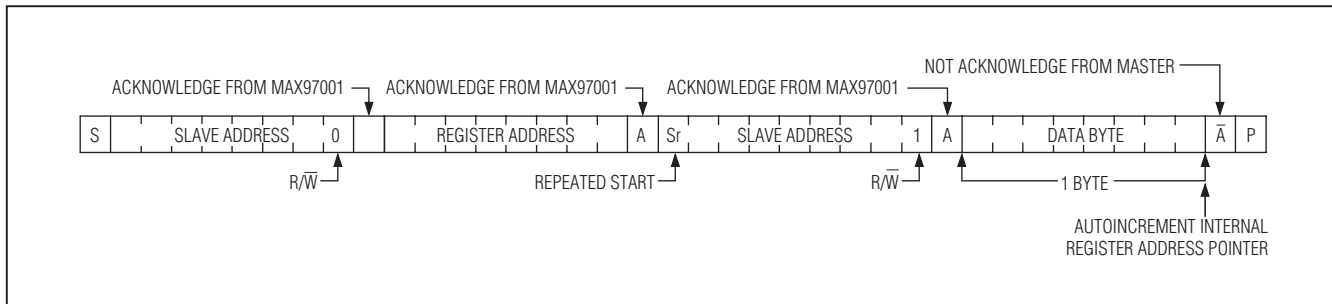

Figure 12. Reading One Byte of Data from the MAX97001

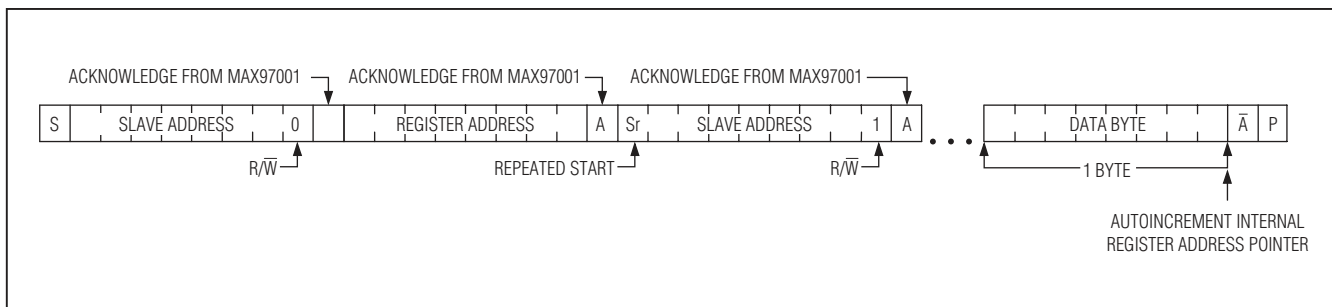

Figure 13. Reading n-Bytes of Data from the MAX97001

Applications Information

Filterless Class D Operation

Traditional Class D amplifiers require an output filter to recover the audio signal from the amplifier's output. The filters add cost, increase the solution size of the amplifier, and can decrease efficiency and THD+N performance. The traditional PWM scheme uses large differential output swings ($2 \times V_{DD(P-P)}$) and causes large ripple currents. Any parasitic resistance in the filter components results in a loss of power, lowering the efficiency.

The MAX97001 does not require an output filter. The device relies on the inherent inductance of the speaker coil and the natural filtering of both the speaker and the human ear to recover the audio component of the square-wave output. Eliminating the output filter results in a smaller, less costly, more efficient solution.

Because the frequency of the MAX97001 output is well beyond the bandwidth of most speakers, voice coil movement due to the square-wave frequency is very small. Although this movement is small, a speaker not designed to handle the additional power can be damaged. For optimum results, use a speaker with a series inductance $> 10\mu\text{H}$. Typical 8Ω speakers exhibit series inductances in the $20\mu\text{H}$ to $100\mu\text{H}$ range.

RF Susceptibility

GSM radios transmit using time-division multiple access (TDMA) with 217Hz intervals. The result is an RF signal with strong amplitude modulation at 217Hz and its harmonics that are easily demodulated by audio amplifiers. The MAX97001 is designed specifically to reject RF signals; however, PCB layout has a large impact on the susceptibility of the end product.

In RF applications, improvements to both layout and component selection decreases the MAX97001's susceptibility to RF noise and prevent RF signals from being demodulated into audible noise. Trace lengths should be kept below $1/4$ of the wavelength of the RF frequency of interest. Minimizing the trace lengths prevents them from functioning as antennas and coupling RF signals into the MAX97001. The wavelength (λ) in meters is given by:

$$\lambda = c/f$$

where $c = 3 \times 10^8$ m/s, and f = the RF frequency of interest.

Route audio signals on middle layers of the PCB to allow ground planes above and below to shield them from RF interference. Ideally, the top and bottom layers of the PCB should primarily be ground planes to create effective shielding.

Audio Subsystem with Mono Class D Speaker and Class H Headphone Amplifiers

Additional RF immunity can also be obtained from relying on the self-resonant frequency of capacitors as it exhibits the frequency response similar to a notch filter. Depending on the manufacturer, 10pF to 20pF capacitors typically exhibit self resonance at RF frequencies. These capacitors when placed at the input pins can effectively shunt the RF noise at the inputs of the MAX97001. For these capacitors to be effective, they must have a low-impedance, low-inductance path to the ground plane. Do not use microvias to connect to the ground plane as these vias do not conduct well at RF frequencies.

Component Selection

Optional Ferrite Bead Filter

Additional EMI suppression can be achieved using a filter constructed from a ferrite bead and a capacitor to ground (Figure 14). Use a ferrite bead with low DC resistance, high-frequency (> 600MHz) impedance between 100Ω and 600Ω, and rated for at least 1A. The capacitor value varies based on the ferrite bead chosen and the actual speaker lead length. Select a capacitor less than 1nF based on EMI performance.

Input Capacitor

An input capacitor, C_{IN} , in conjunction with the input impedance of the MAX97001 line inputs forms a high-pass filter that removes the DC bias from an incoming analog signal. The AC-coupling capacitor allows the amplifier to automatically bias the signal to an optimum DC level. Assuming zero-source impedance, the -3dB point of the highpass filter is given by:

$$f_{-3dB} = \frac{1}{2\pi R_{IN} C_{IN}}$$

Choose C_{IN} such that f_{-3dB} is well below the lowest frequency of interest. For best audio quality, use capacitors whose dielectrics have low-voltage coefficients, such as tantalum or aluminum electrolytic. Capacitors with high-voltage coefficients, such as ceramics, may result in increased distortion at low frequencies.

Charge-Pump Capacitor Selection

Use capacitors with an ESR less than 100mΩ for optimum performance. Low-ESR ceramic capacitors minimize the output resistance of the charge pump. Most surface-mount ceramic capacitors satisfy the ESR requirement. For best performance over the extended temperature range, select capacitors with an X7R dielectric.

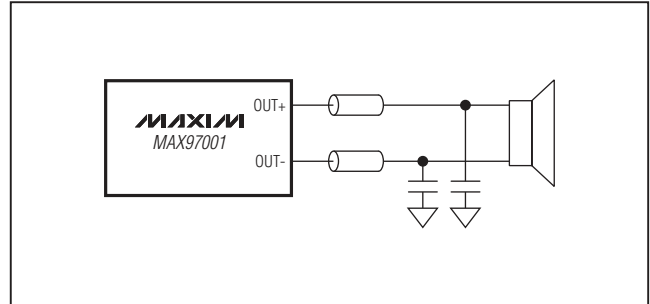

Figure 14. Optional Class D Ferrite Bead Filter

Charge-Pump Flying Capacitor

The value of the flying capacitor (connected between C1N and C1P) affects the output resistance of the charge pump. A value that is too small degrades the device's ability to provide sufficient current drive, which leads to a loss of output voltage. Increasing the value of the flying capacitor reduces the charge-pump output resistance to an extent. Above 1μF, the on-resistance of the internal switches and the ESR of external charge-pump capacitors dominate.

Charge-Pump Holding Capacitor

The holding capacitor (bypassing HPVDD and HPVSS) value and ESR directly affect the ripple on the supply. Increasing the capacitor's value reduces output ripple. Likewise, decreasing the ESR reduces both ripple and output resistance. Lower capacitance values can be used in systems with low maximum output power levels. See the Output Power vs. Load Resistance graph in the *Typical Operating Characteristics* for more information.

Supply Bypassing, Layout, and Grounding

Proper layout and grounding are essential for optimum performance. Use a large continuous ground plane on a dedicated layer of the PCB to minimize loop areas. Connect GND directly to the ground plane using the shortest trace length possible. Proper grounding improves audio performance, minimizes crosstalk between channels, and prevents any digital noise from coupling into the analog audio signals.

Place the capacitor between C1P and C1N as close to the MAX97001 as possible to minimize trace length from C1P to C1N. Inductance and resistance added between C1P and C1N reduce the output power of the headphone amplifier. Bypass HPVDD and HPVSS with capacitors located close to the pins with a short trace length to GND. Close decoupling of HPVDD and HPVSS minimizes supply ripple and maximizes output power from the headphone amplifier.

Audio Subsystem with Mono Class D Speaker and Class H Headphone Amplifiers

Bypass PVDD to GND with as little trace length as possible. Connect OUTP and OUTN to the speaker using the shortest and widest traces possible. Reducing trace length minimizes radiated EMI. Route OUTP/OUTN as a differential pair on the PCB to minimize the loop area thereby reducing the inductance of the circuit. If filter components are used on the speaker outputs, be sure to locate them as close as possible to the MAX97001 to ensure maximum effectiveness. Minimize the trace length from any ground tied passive components to GND to further minimize radiated EMI.

An evaluation kit (EV kit) is available to provide an example layout for the MAX97001. The EV kit allows quick setup of the MAX97001 and includes easy-to-use software, allowing all internal registers to be controlled.

WLP Applications Information

For the latest application details on WLP construction, dimensions, tape carrier information, PCB techniques, bump-pad layout, and the recommended reflow temperature profile, as well as the latest information on reliability testing results, refer to the *Application Note 1891: Wafer-Level Packaging (WLP) and Its Applications* on Maxim's website at www.maxim-ic.com/ucsp. See Figure 15 for the recommended PCB footprint for the MAX97001.

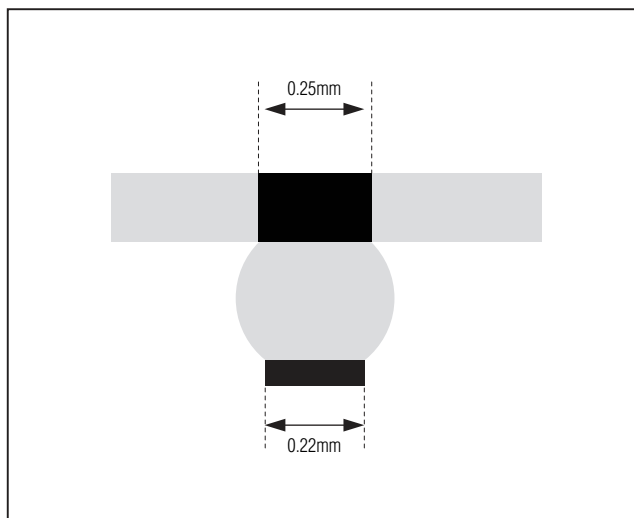

Figure 15. Recommended PCB Footprint

Audio Subsystem with Mono Class D Speaker and Class H Headphone Amplifiers

Package Information

For the latest package outline information and land patterns, go to www.maxim-ic.com/packages. Note that a "+", "#", or "-" in the package code indicates RoHS status only. Package drawings may show a different suffix character, but the drawing pertains to the package regardless of RoHS status.

| PACKAGE TYPE | PACKAGE CODE | OUTLINE NO. | LAND PATTERN NO. |
|--------------|--------------|-------------------------|------------------|
| 20 WLP | W202A2+2 | 21-0059 | — |

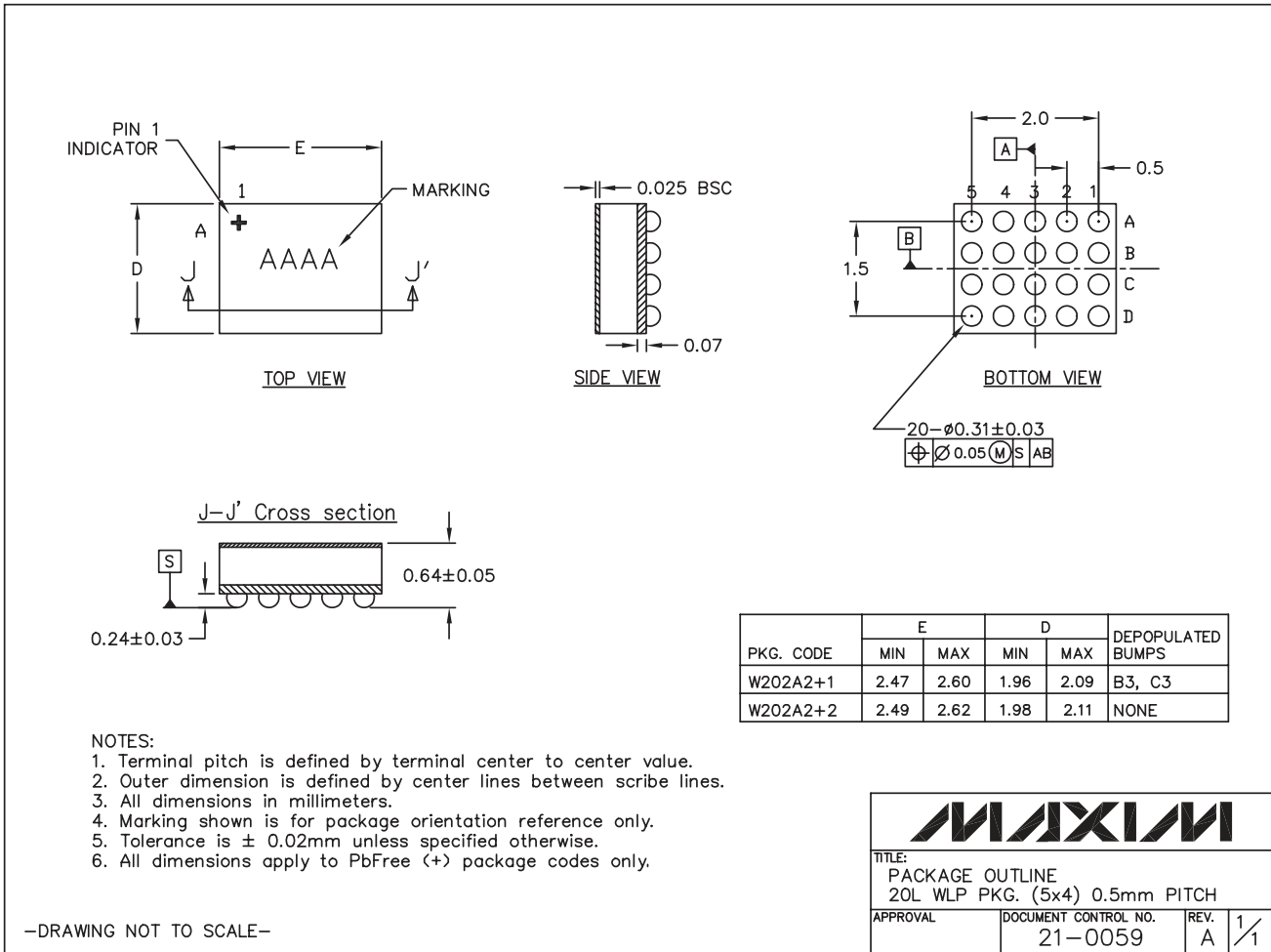

20L WLP.EPS

Audio Subsystem with Mono Class D Speaker and Class H Headphone Amplifiers

Revision History

| REVISION NUMBER | REVISION DATE | DESCRIPTION | PAGES CHANGED |
|-----------------|---------------|----------------------------------|---------------|
| 0 | 1/10 | Initial release | — |
| 1 | 7/10 | Corrected mixer bit descriptions | 25 |

MAX97001

Maxim cannot assume responsibility for use of any circuitry other than circuitry entirely embodied in a Maxim product. No circuit patent licenses are implied. Maxim reserves the right to change the circuitry and specifications without notice at any time.

Maxim Integrated Products, 120 San Gabriel Drive, Sunnyvale, CA 94086 408-737-7600 _____ **37**