

MIL-DTL-5015 / AS50151 Features and Application Series III



Features and Application

The threaded coupling, environmentally sealed MIL-DTL-5015 Series III connector with rear-removable crimp contacts was developed to replace the earlier solder type. This redesigned connector is intermateable and intermountable with the MIL-DTL-5015 Series I solder type (MS310*) as well as the MIL-DTL- 83723 Series II (USAF) crimp type and MIL-DTL-5015 Series II Front Release (MS340*). Thus, it provides for a minimum effort and high economy upgrade for existing applications.

These connectors are recommended for a wide range of applications, from commercial/industrial and mass transportation systems to the most stringent high reliability defense and aerospace requirements.

This family of connectors is offered in four receptacle mounting configurations. They include two square flange receptacles, both wall and box mounting; cable connecting receptacles; and jam nut receptacles which incorporate “O” ring seals, designed for rear panel “D” hole mounting.

Two plug styles are offered - standard plug with free rotating coupling nut with safety wire holes, and a self-locking, anti-decoupling plug, which eliminates the need for safety wiring.

Eighty-eight insert arrangements per MIL-STD-1651 are tooled and qualified to MIL-DTL-5015, utilizing 1 to 85 contacts. Contacts come in sizes 16, 12, 8, 4 and 0, terminating wire sizes from 20 gauge to 0 gauge.

These connectors are available in wide range of shell materials and finishes. Aluminum shells are offered in both electroless nickel and olive drab cadmium to both commercial and MS callouts. Other finishes such as anodic and zinc cobalt are available upon request to commercial callouts only. In addition, we offer passivated stainless steel shells with both standard and firewall-rated inserts, and carbon steel shells with firewall inserts.

Lockwiring Eliminated – Self-locking plug eliminates the need for lockwiring.

Universal I/R Tool – A single, expendable plastic tool is used for both insertion and removal of contacts.

Insert Polarization – Alternate insert clocking positions aid in mating of adjacent connectors having identical insert arrangement.

Closed-Entry Socket Insert – Hard dielectric socket face has lead-in chamfers for positive alignment of pins (even partially bent within pre-established limits) with sockets.

Interfacial Pin Insert Seal – Raised moisture barriers around each pin, which mate into lead-in chamfers of hard face socket insert, provide individual contact sealing. Interfacial seal is never touched by service tools.

Elastomer Wire Sealing Grommet – Sealing over a wide range of wire diameters is assured by a triple wire seal in each cavity at the rear of the connector.

Superior Contact Stability – Rear release crimp contact system features a stamped beryllium-copper retaining clip captivated by molded-in shoulders of each contact cavity in the insulator. A rear-inserted M81969 plastic tool expands the tines beyond the shoulder, releasing the contact.





MIL-DTL-5015 / AS5015
Performance Specifications
MS345*/AE55*

Performance Specifications

Operating Temperature Range

Classes KS and LS: -55°C to +200°C (-67°F to +392°F)
 Classes KT and W: -55°C to +175°C (-67°F to +347°F)
 Class L: -55°C to +200°C (-67°F to +392°F)
 Class A*: -55°C to +200°C (-67°F to +392°F)

Material and Finish Data (Class)

KT – carbon steel shell, olive drab cadmium, firewall
 KS – stainless steel shell, passivated, firewall
 L – aluminum shell, electroless nickel finish
 LS – stainless steel shell, passivated
 W – aluminum shell, olive drab cadmium over nickel base
 A* – aluminum shell, black anodized finish

Corrosion Resistance

Classes KS and LS withstand 1,000-hour salt spray.
 Class KT withstands 96-hour salt spray.
 Class L withstands 96-hour salt spray.
 Class W withstands 1,000-hour salt spray.

Environmental Seal

Wired, mated connectors with specified accessories attached, shall meet the altitude-immersion test specified in MIL-DTL-5015.

Durability

Minimum of 100 mating cycles

Voltage Rating

Service Rating	Maximum Operating Voltage**		Test Voltage	Test Voltage	Test Voltage	Test Voltage
	(Sea Level)		Sea Level	50,000 Ft	70,000 Ft.	110,000 Ft.
	AC (RMS)	DC	V RMS	V RMS	V RMS	V RMS
Inst.	200	250	1000	400	260	200
A	500	700	2000	600	360	200
D	900	1250	2800	675	400	200
E	1250	1750	3500	750	440	200
B	1750	2450	4500	825	480	200
C	3000	4200	7000	975	560	200

* Not MS approved, available to Aero-Electric part number only.

**To be used by designer only as a guide.

Shock and Vibration Requirements

Wired, mated connectors shall not be damaged, coupling ring shall not loosen, and there shall be no interruption of electrical continuity longer than 10 microseconds when subjected to the following:

Shock

Mated connectors withstand a pulse of approximate half sine wave of 50 G magnitude with duration of 11 milliseconds applied in three axes per MIL-STD-1344, method 2004, test condition A.

Vibration

Mated connectors withstand the following vibration levels:

- Random vibration per MIL-STD-1344, method 2005, and test condition VI, letter J.

Shell-to-Shell Conductivity

Maximum potential drop shall not exceed:

- Class W = 5 millivolts
- All other classes (except A*) = 50 millivolts

Fluid Resistance

Connectors resist specified immersions in MIL-PRF-7808 (lubricating oil), MIL-PRF-23699 (lubricating oil), MIL-PRF-5606 (hydraulic fluid), M2-V Chevron oil, Coolanol 25, MIL-DTL-83133 (turbine fuel JP-8), MIL-DTL-5624 (turbine fuels JP-4 and JP-5), SAE-AMS1424 Type I (defrosting fluid), and other solvents and cleaning agents.

MIL-DTL-5015 Series III /AS50151
Part Number Development
Rear Release



Military and Aero-Electric Part Number Development

Mil. Prefix	MS34	50	L	14S -	5	P	X	
Aero Prefix	AE5	50	L	14S -	5	P	X	-340
Shell Type								
50 = Wall mount receptacle								
51 = Cable connecting receptacle								
52 = Box mount receptacle								
54 = Jam nut receptacle								
56 = Straight plug								
59 = Self-locking plug								
Class (Material and Finish)								
A = Aluminum shell, black anodized finish (Aero part number only)								
KS = Stainless steel shell, passivated, firewall (n/a in MS3451, MS3452, MS3454)								
KT = Carbon steel shell, cadmium finish, firewall (n/a in MS3451, MS3452, MS3454)								
LS = Stainless steel shell, passivated								
L = Aluminum shell, electroless nickel finish								
W = Aluminum shell, olive drab cadmium over electroless nickel base								
Shell Size								
8S, 10S, 10SL, 12, 12S, 14, 14S, 16, 16S, 18, 20, 22, 24, 28, 32, 36 or 40								
Insert Arrangement								
See pages 82 thru 87								
Contact Style								
P = Pin								
S = Socket								
A = Pin connector less pins (with intent to use non-std contact)								
B = Socket connector less sockets (with intent to use non-std contacts)								
Polarization								
N = Normal (not included in part number)								
W, X, Y or Z = Alternate insert polarizations (see pages 77 thru 81 for position availability)								
Modification (applies to Aero part numbers only)								
01 = Less contacts (is not marked on the part)								
340 = Connector kitted with M85049/31-XXX E-nut								
341 = Connector kitted with M85049/52-1-XXX straight clamp								
342 = Connector kitted with M85049/51-1-XXX right angle clamp								
Consult factory for other modifications								

Note 1: Each connector is furnished with contacts unless ordered less contacts (L/C) as follows: One spare contact for inserts requiring 2 to 26 of each contact and two spares for inserts with 27 or more of each size, and a minimum of one sealing plug up to 15% of the number contacts. No spares or seal plugs are provided with one contact layouts. No spares or seal plugs for contact sizes 0 and 4 are provided. For contact size 8, no contact spares are provided, but seal plugs are included. In addition, one insertion/removal tool of each size is included.

Note 2: KS and KT firewall classes are only available to Military part numbers for shell types MS3450, MS3456 and MS3459. KS and KT classes are available to Aero callouts for AE551 and 554, but not for AE552 (box mount receptacle).

Note 3: Proper part number marking has no “0” in front of single digit (numeric) shell size (8S) and no “0” in front of single digit layout. Examples: J MS3450W8S-1S and J MS3450W24-2PW. Please note that J or JAN marking is required immediately in front of MS part number.



Threaded Coupling, Crimp Removable, Rear Release

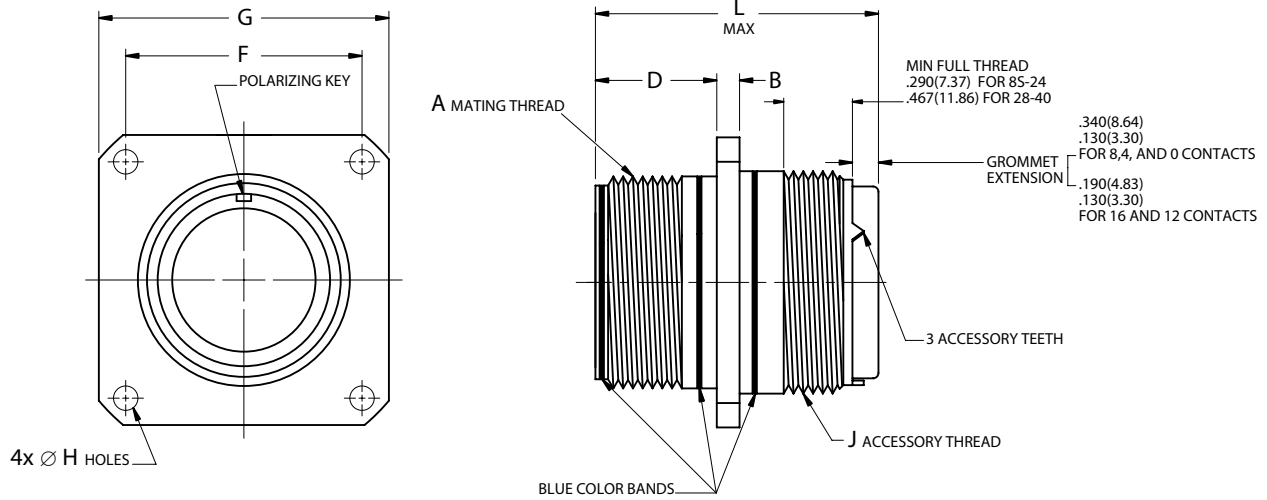

Page 65	Completed Part Number
Page 75	Contacts, Sealing Plugs and Tools
Pages 82–87	Insert Arrangements
Page 64	Performance Specifications
Pages 77–81	Insert Availability and Contact Information
Page 77	Polarization

Note 1: L MAX is same as L MAX for AE551 on next page.

Note 2: Maximum grommet O.D. is same as Ø E MAX for AE551 on next page.

5015 S III

Shell Size	A	B		D		F		G		Ø H				J
	Mating Thread Class 2A	±.015	±.38	+0.031 -0.000	+0.79 -0.00	(TP)		±.031	±.79	Classes L, LS, W +.010 -.005	Classes KS, KT +.010 -.005	Classes L, LS, W +.010 -.005	Classes KS, KT +.010 -.005	Accessory Thread Class 2A
		inch	mm	inch	mm	inch	mm	inch	mm	inch	mm	inch	mm	
8S	1/2-28 UNEF	.083	2.11	.562	14.27	.594	15.09	.875	22.23	.120	3.05	.150	3.81	1/2-20UNF
10S	5/8-24 UNEF	.083	2.11	.562	14.27	.719	18.26	1.000	25.40	.120	3.05	.150	3.81	5/8-24UNEF
10SL	5/8-24 UNEF	.083	2.11	.562	14.27	.719	18.26	1.000	25.40	.120	3.05	.150	3.81	5/8-24UNEF
12	3/4-20 UNEF	.083	2.11	.750	19.05	.812	20.62	1.094	27.79	.120	3.05	.150	3.81	3/4-20UNEF
12S	3/4-20 UNEF	.083	2.11	.562	14.27	.812	20.62	1.094	27.79	.120	3.05	.150	3.81	3/4-20UNEF
14	7/8-20 UNEF	.083	2.11	.750	19.05	.906	23.01	1.188	30.18	.120	3.05	.150	3.81	7/8-20UNEF
14S	7/8-20 UNEF	.083	2.11	.562	14.27	.906	23.01	1.188	30.18	.120	3.05	.150	3.81	7/8-20UNEF
16	1-20 UNEF	.083	2.11	.750	19.05	.969	24.61	1.281	32.54	.120	3.05	.150	3.81	1-20UNEF
16S	1-20 UNEF	.083	2.11	.562	14.27	.969	24.61	1.281	32.54	.120	3.05	.150	3.81	1-20UNEF
18	1 1/8-18 UNEF	.125	3.18	.750	19.05	1.062	26.97	1.375	34.93	.120	3.05	.177	4.50	1-1/16-18UNEF
20	1 1/4-18 UNEF	.125	3.18	.750	19.05	1.156	29.36	1.500	38.10	.120	3.05	.177	4.50	1-3/16-18UNEF
22	1 3/8-18 UNEF	.125	3.18	.750	19.05	1.250	31.75	1.625	41.28	.120	3.05	.177	4.50	1-5/16-18UNEF
24	1 1/2-18 UNEF	.125	3.18	.812	20.62	1.375	34.93	1.750	44.45	.147	3.73	.177	4.50	1-7/16-18UNEF
28	1 3/4-18 UNS	.125	3.18	.812	20.62	1.562	39.67	2.000	50.80	.147	3.73	.177	4.50	1-3/4-18UNS
32	2-18 UNS	.125	3.18	.875	22.23	1.750	44.45	2.250	57.15	.173	4.39	.209	5.31	2-18UNS
36	2 1/4-16 UN	.125	3.18	.875	22.23	1.938	49.23	2.500	63.50	.173	4.39	.209	5.31	2-1/4-16UN
40	2 1/2-16 UN	.125	3.18	.875	22.23	2.188	55.58	2.750	69.85	.173	4.39	.209	5.31	2-1/2-16UN

MS3451 per AS34511
Cable Connecting Receptacle
AE551



Threaded Coupling, Crimp Removable, Rear Release

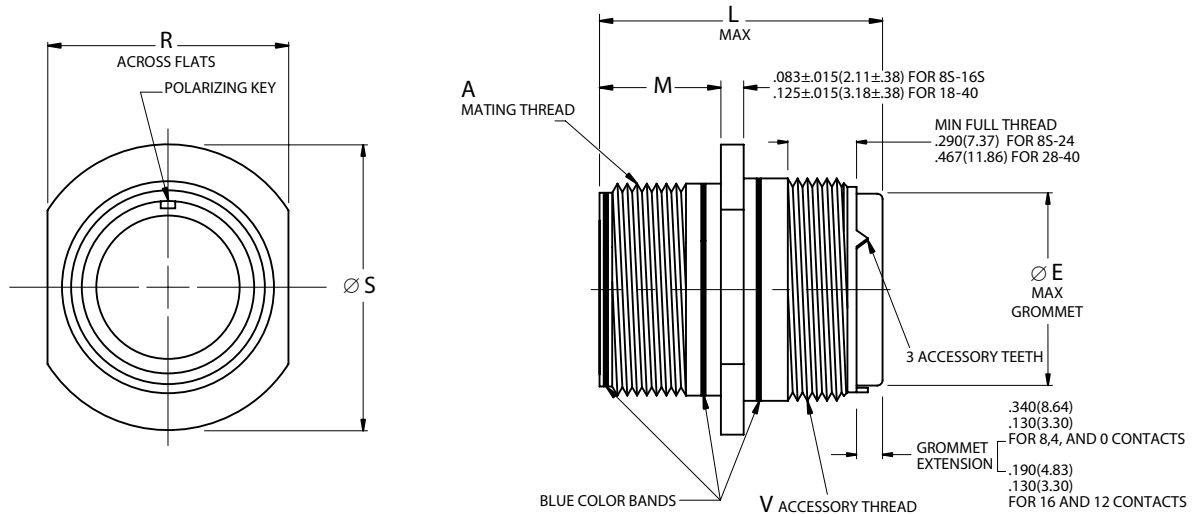

- Page 65 Completed Part Number
- Page 75 Contacts, Sealing Plugs and Tools
- Pages 82–87 Insert Arrangements
- Page 64 Performance Specifications
- Pages 77–81 Insert Availability and Contact Information
- Page 77 Polarization

5015 S III

Shell Size	A	Ø E		L MAX				M		R		Ø S		V
	Mating Thread Class 2A	Maximum		16 & 12 Contacts		8, 4 & 0 Contacts		+.031 -.000				±.031 ±.79		Accessory Thread Class 2A
		inch	mm	inch	mm	inch	mm	inch	mm	inch	mm	inch	mm	
8S	1/2-28 UNEF	.305	7.75	2.031	51.59	–	–	.562	14.27	.504/.496	12.80/12.60	.729	18.52	1/2-20UNF
10S	5/8-24 UNEF	.405	10.29	2.031	51.59	–	–	.562	14.27	.629/.621	15.98/15.77	.854	21.69	5/8-24UNEF
10SL	5/8-24 UNEF	.405	10.29	2.031	51.59	–	–	.562	14.27	.629/.621	15.98/15.77	.854	21.69	5/8-24UNEF
12	3/4-20 UNEF	.549	13.94	2.125	53.98	–	–	.750	19.05	.754/.746	19.15/18.95	.974	24.74	3/4-20UNEF
12S	3/4-20 UNEF	.549	13.94	2.031	51.59	–	–	.562	14.27	.754/.746	19.15/18.95	.974	24.74	3/4-20UNEF
14	7/8-20 UNEF	.665	16.89	2.125	53.98	–	–	.750	19.05	.879/.871	22.33/22.12	1.099	27.91	7/8-20UNEF
14S	7/8-20 UNEF	.665	16.89	2.031	51.59	–	–	.562	14.27	.879/.871	22.33/22.12	1.099	27.91	7/8-20UNEF
16	1-20 UNEF	.790	20.07	2.125	53.98	2.500	63.50	.750	19.05	1.005/.996	25.53/25.30	1.224	31.09	1-20UNEF
16S	1-20 UNEF	.790	20.07	2.031	51.59	–	–	.562	14.27	1.005/.996	25.53/25.30	1.224	31.09	1-20UNEF
18	1 1/8-18 UNEF	.869	22.07	2.125	53.98	2.500	63.50	.750	19.05	1.131/1.121	28.73/28.47	1.349	34.26	1-1/16-18UNEF
20	1 1/4-18 UNEF	.994	25.25	2.125	53.98	2.500	63.50	.750	19.05	1.256/1.246	31.90/31.65	1.474	37.44	1-3/16-18UNEF
22	1 3/8-18 UNEF	1.119	28.42	2.125	53.98	2.500	63.50	.750	19.05	1.381/1.371	35.08/34.82	1.599	40.61	1-5/16-18UNEF
24	1 1/2-18 UNEF	1.244	31.60	2.125	53.98	2.500	63.50	.812	20.62	1.506/1.496	38.25/38.00	1.715	43.56	1-7/16-18UNEF
28	1 3/4-18 UNS	1.465	37.21	2.125	53.98	2.500	63.50	.812	20.62	1.756/1.746	44.60/44.35	1.974	50.14	1-3/4-18UNS
32	2-18 UNS	1.715	43.56	2.125	53.98	2.500	63.50	.875	22.23	2.007/1.996	50.98/50.70	2.224	56.49	2-18UNS
36	2 1/4-16 UN	1.930	49.02	2.125	53.98	2.500	63.50	.875	22.23	2.257/2.246	57.33/57.05	2.474	62.84	2-1/4-16UN
40	2 1/2-16 UN	2.145	54.48	2.125	53.98	2.500	63.50	.875	22.23	2.511/2.496	63.78/63.40	2.724	69.19	2-1/2-16UN

Threaded Coupling, Crimp Removable, Rear Release

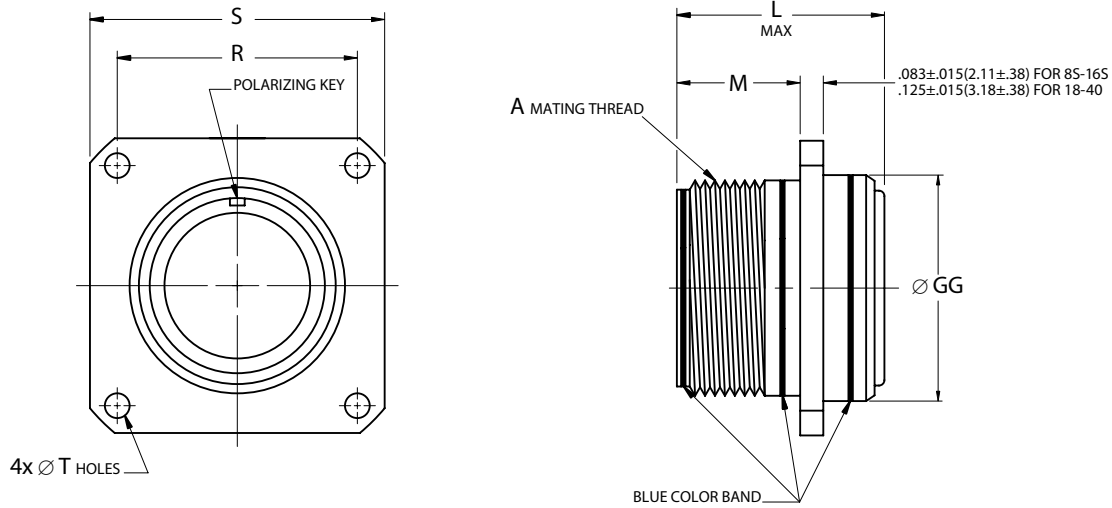

Page 65 Completed Part Number
 Page 75 Contacts, Sealing Plugs and Tools
 Pages 82–87 Insert Arrangements
 Page 64 Performance Specifications
 Pages 77–81 Insert Availability and Contact Information
 Page 77 Polarization

Note 1: The insulation material shall be above, flush with, or no more than .015 inches (.38 mm) below the metal shell.

5015 S III

Shell Size	A	Ø GG		L MAX				M		R		S		Ø T	
	Mating Thread Class 2A	±.016	±.41	16 & 12 Contacts		8, 4 & 0 Contacts		+031 -000	+079 -00	(TP)		±.031	±.79	+010 -005	+025 -013
		inch	mm	inch	mm	inch	mm	inch	mm	inch	mm	inch	mm	inch	mm
85	1/2-28 UNEF	.500	12.70	1.662	42.21	-	-	.562	14.27	.594	15.09	.875	22.23	.120	3.05
10S	5/8-24 UNEF	.625	15.88	1.662	42.21	-	-	.562	14.27	.719	18.26	1.000	25.40	.120	3.05
10SL	5/8-24 UNEF	.625	15.88	1.662	42.21	-	-	.562	14.27	.719	18.26	1.000	25.40	.120	3.05
12	3/4-20 UNEF	.750	19.05	1.662	42.21	-	-	.750	19.05	.812	20.62	1.094	27.79	.120	3.05
12S	3/4-20 UNEF	.750	19.05	1.662	42.21	-	-	.562	14.27	.812	20.62	1.094	27.79	.120	3.05
14	7/8-20 UNEF	.875	22.23	1.662	42.21	-	-	.750	19.05	.906	23.01	1.188	30.18	.120	3.05
14S	7/8-20 UNEF	.875	22.23	1.662	42.21	-	-	.562	14.27	.906	23.01	1.188	30.18	.120	3.05
16	1-20 UNEF	1.000	25.40	1.662	42.21	1.937	49.20	.750	19.05	.969	24.61	1.281	32.54	.120	3.05
16S	1-20 UNEF	1.000	25.40	1.662	42.21	-	-	.562	14.27	.969	24.61	1.281	32.54	.120	3.05
18	1 1/8-18 UNEF	1.062	26.97	1.662	42.21	1.937	49.20	.750	19.05	1.062	26.97	1.375	34.93	.120	3.05
20	1 1/4-18 UNEF	1.187	30.15	1.662	42.21	1.937	49.20	.750	19.05	1.156	29.36	1.500	38.10	.120	3.05
22	1 3/8-18 UNEF	1.312	33.32	1.662	42.21	1.937	49.20	.750	19.05	1.250	31.75	1.625	41.28	.120	3.05
24	1 1/2-18 UNEF	1.437	36.50	1.662	42.21	1.937	49.20	.812	20.62	1.375	34.93	1.750	44.45	.147	3.73
28	1 3/4-18 UNS	1.750	44.45	1.662	42.21	1.937	49.20	.812	20.62	1.562	39.67	2.000	50.80	.147	3.73
32	2-18 UNS	2.000	50.80	1.662	42.21	1.937	49.20	.875	22.23	1.750	44.45	2.250	57.15	.173	4.39
36	2 1/4-16 UN	2.250	57.15	1.662	42.21	1.937	49.20	.875	22.23	1.938	49.23	2.500	63.50	.173	4.39
40	2 1/2-16 UN	2.500	63.50	1.662	42.21	1.937	49.20	.875	22.23	2.188	55.58	2.750	69.85	.173	4.39

MS3454 per AS34541
Jam Nut Receptacle
AE554



Threaded Coupling, Crimp Removable, Rear Release

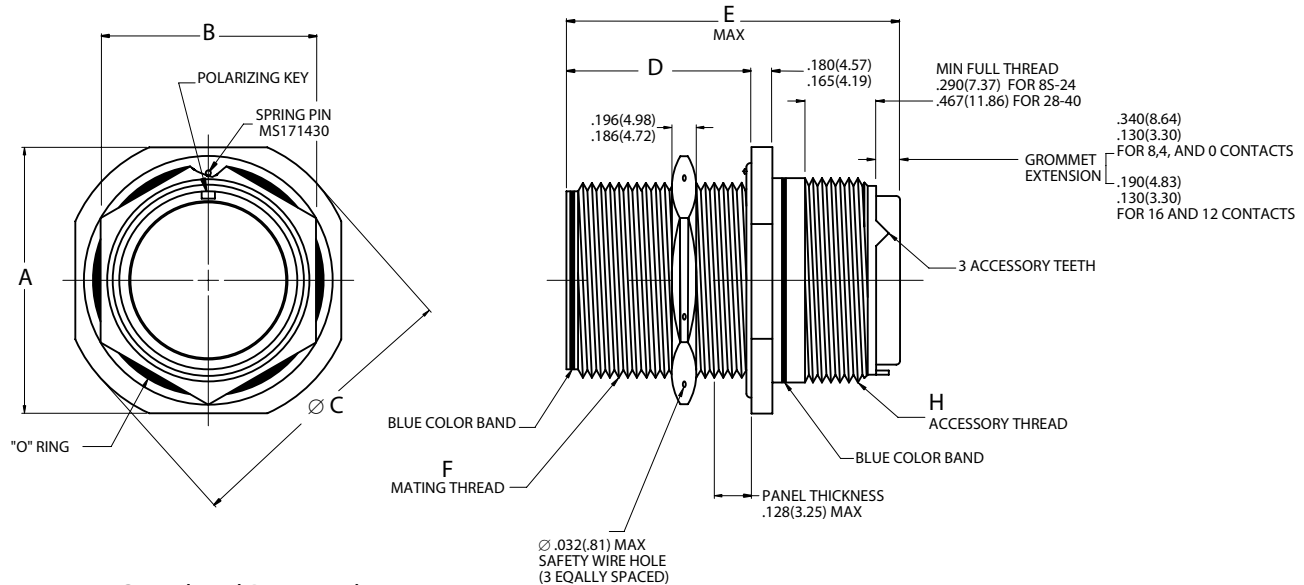

Page 65 Completed Part Number
 Page 75 Contacts, Sealing Plugs and Tools
 Pages 82–87 Insert Arrangements
 Page 64 Performance Specifications
 Pages 77–81 Insert Availability and Contact Information
 Page 77 Polarization

Note: Maximum grommet O.D. is same as $\varnothing E$ MAX on next page.

Shell Size	A		B		$\varnothing C$		D		E MAX		F	H		
	$\pm .005$	$\pm .13$	$\pm .010$	$\pm .25$	$\pm .005$	$\pm .13$	$\pm .005$	$\pm .13$	16 & 12 Contacts	8, 4 & 0 Contacts	Mating Thread Class 2A	Accessory Thread Class 2A		
	inch	mm	inch	mm	inch	mm	inch	mm	inch	mm				
8S	1.187	30.15	.687	17.45	1.272	32.31	.720	18.29	2.031	51.59	–	–	1/2-28 UNEF	1/2-20UNF
10S	1.312	33.32	.812	20.62	1.397	35.48	.720	18.29	2.031	51.59	–	–	5/8-24 UNEF	5/8-24UNEF
10SL	1.312	33.32	.812	20.62	1.397	35.48	.720	18.29	2.031	51.59	–	–	5/8-24 UNEF	5/8-24UNEF
12	1.437	36.50	.937	23.80	1.522	38.66	.970	24.64	2.125	53.98	–	–	3/4-20 UNEF	3/4-20UNEF
12S	1.437	36.50	.937	23.80	1.522	38.66	.720	18.29	2.031	51.59	–	–	3/4-20 UNEF	3/4-20UNEF
14	1.562	39.67	1.125	28.58	1.647	41.83	.970	24.64	2.125	53.98	–	–	7/8-20 UNEF	7/8-20UNEF
14S	1.562	39.67	1.125	28.58	1.647	41.83	.720	18.29	2.031	51.59	–	–	7/8-20 UNEF	7/8-20UNEF
16	1.687	42.85	1.250	31.75	1.772	45.01	.970	24.64	2.125	53.98	2.500	63.50	1-20 UNEF	1-20UNEF
16S	1.687	42.85	1.250	31.75	1.772	45.01	.720	18.29	2.031	51.59	–	–	1-20 UNEF	1-20UNEF
18	1.812	46.02	1.375	34.93	1.897	48.18	.970	24.64	2.125	53.98	2.500	63.50	1 1/8-18 UNEF	1-1/16-18UNEF
20	1.937	49.20	1.500	38.10	2.022	51.36	.970	24.64	2.125	53.98	2.500	63.50	1 1/4-18 UNEF	1-3/16-18UNEF
22	2.156	54.76	1.625	41.28	2.241	56.92	.970	24.64	2.125	53.98	2.500	63.50	1 3/8-18 UNEF	1-5/16-18UNEF
24	2.281	57.94	1.750	44.45	2.366	60.10	.970	24.64	2.125	53.98	2.500	63.50	1 1/2-18 UNEF	1-7/16-18UNEF
28	2.531	64.29	2.000	50.80	2.616	66.45	.970	24.64	2.125	53.98	2.500	63.50	1 3/4-18 UNS	1-3/4-18UNS
32	2.781	70.64	2.375	60.33	2.866	72.80	.970	24.64	2.125	53.98	2.500	63.50	2-18 UNS	2-18UNS
36	3.031	76.99	2.625	66.68	3.116	79.15	.970	24.64	2.125	53.98	2.500	63.50	2 1/4-16 UN	2-1/4-16UN
40	3.281	83.34	2.875	73.03	3.366	85.50	.970	24.64	2.125	53.98	2.500	63.50	2 1/2-16 UN	2-1/2-16UN



MS3456 per AS34561
Straight Plug
AE556

Threaded Coupling, Crimp Removable, Rear Release

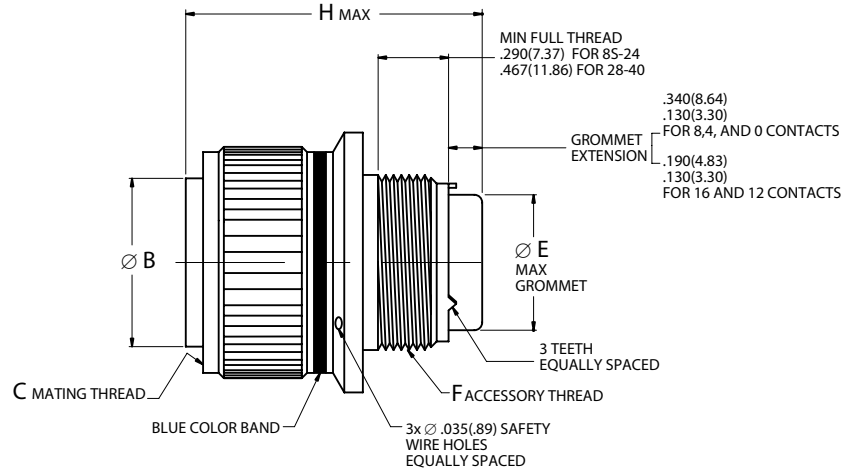
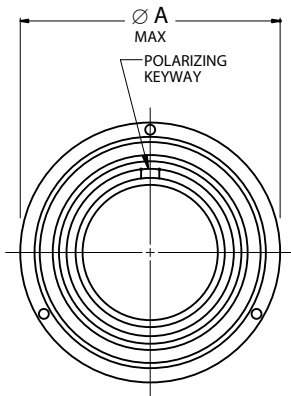

Page 65	Completed Part Number
Page 75	Contacts, Sealing Plugs and Tools
Pages 82-87	Insert Arrangements
Page 64	Performance Specifications
Pages 77-81	Insert Availability and Contact Information
Page 77	Polarization

5015 S III

Shell Size	Ø A		Ø B		C	Ø E		F	H MAX					
	Maximum		±.005	±.13		Mating Thread	Maximum		Accessory Thread		16 & 12 Contacts		8, 4 & 0 Contacts	
	inch	mm	inch	mm	Class 2B	inch	mm	inch	mm	inch	mm	inch	mm	
8S	.844	21.44	.360	9.14	1/2-28 UNEF	.305	7.75	1/2-20UNF	2.031	51.59	-	-	-	-
10S	.969	24.61	.435	11.05	5/8-24 UNEF	.405	10.29	5/8-24UNEF	2.031	51.59	-	-	-	-
10SL	.969	24.61	.443*	11.25*	5/8-24 UNEF	.405	10.29	5/8-24UNEF	2.031	51.59	-	-	-	-
12	1.062	26.97	.550	13.97	3/4-20 UNEF	.549	13.94	3/4-20UNEF	2.125	53.98	-	-	-	-
12S	1.062	26.97	.550	13.97	3/4-20 UNEF	.549	13.94	3/4-20UNEF	2.031	51.59	-	-	-	-
14	1.156	29.36	.670	17.02	7/8-20 UNEF	.665	16.89	7/8-20UNEF	2.125	53.98	-	-	-	-
14S	1.156	29.36	.670	17.02	7/8-20 UNEF	.665	16.89	7/8-20UNEF	2.031	51.59	-	-	-	-
16	1.250	31.75	.800	20.32	1-20 UNEF	.790	20.07	1-20UNEF	2.125	53.98	2.500	63.50	-	-
16S	1.250	31.75	.800	20.32	1-20 UNEF	.790	20.07	1-20UNEF	2.031	51.59	-	-	-	-
18	1.344	34.14	.925	23.50	1 1/8-18 UNEF	.869	22.07	1-1/16-18UNEF	2.125	53.98	2.500	63.50	-	-
20	1.469	37.31	1.045	26.54	1 1/4-18 UNEF	.994	25.25	1-3/16-18UNEF	2.125	53.98	2.500	63.50	-	-
22	1.594	40.49	1.170	29.72	1 3/8-18 UNEF	1.119	28.42	1-5/16-18UNEF	2.125	53.98	2.500	63.50	-	-
24	1.719	43.66	1.295	32.89	1 1/2-18 UNEF	1.244	31.60	1-7/16-18UNEF	2.125	53.98	2.500	63.50	-	-
28	1.969	50.01	1.515	38.48	1 3/4-18 UNS	1.465	37.21	1-3/4-18UNS	2.125	53.98	2.500	63.50	-	-
32	2.219	56.36	1.765	44.83	2-18 UNS	1.715	43.56	2-18UNS	2.125	53.98	2.500	63.50	-	-
36	2.469	62.71	1.975	50.17	2 1/4-16 UN	1.930	49.02	2-1/4-16UN	2.125	53.98	2.500	63.50	-	-
40	2.719	69.06	2.225	56.52	2 1/2-16 UN	2.145	54.48	2-1/2-16UN	2.125	53.98	2.500	63.50	-	-

* Tolerance for this dimension is ± .003(.08)

MS3459 per AS34591
Self-Locking Plug
AE559



Threaded Coupling, Crimp Removable, Rear Release

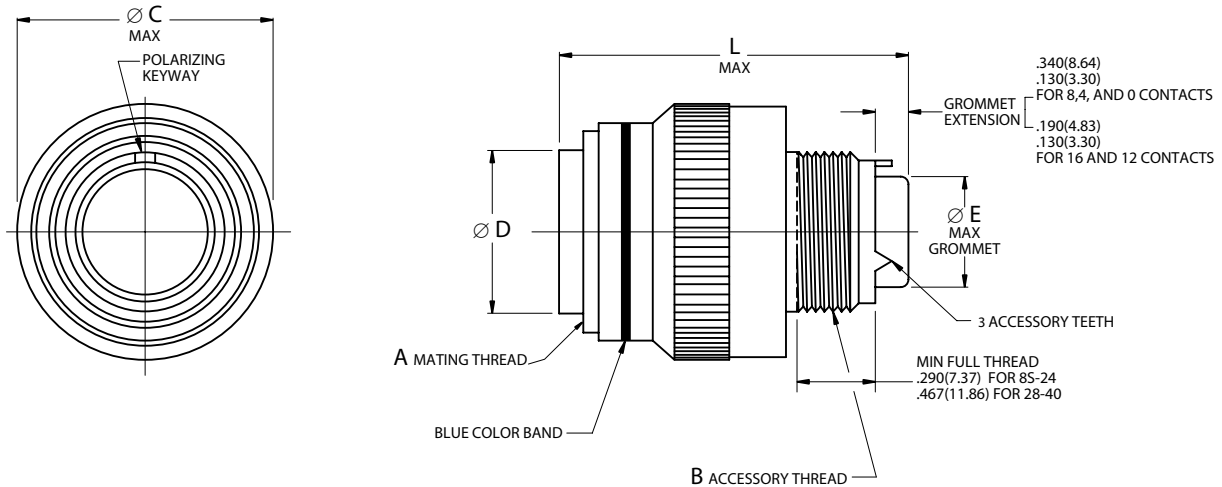

Page 65	Completed Part Number
Page 75	Contacts, Sealing Plugs and Tools
Pages 82–87	Insert Arrangements
Page 64	Performance Specifications
Pages 77–81	Insert Availability and Contact Information
Page 77	Polarization

5015 S III

Shell Size	A	B	$\varnothing C$		$\varnothing D$		$\varnothing E$		L MAX			
	Mating Thread Class 2B	Accessory Thread Class 2A	Maximum		$\pm .005$	$\pm .13$	Maximum		16 & 12 Contacts		8, 4 & 0 Contacts	
			inch	mm	inch	mm	inch	mm	inch	mm	inch	mm
8S	1/2-28 UNEF	1/2-20UNF	.963	24.46	.360	9.14	.305	7.75	2.031	51.59	-	-
10S	5/8-24 UNEF	5/8-24UNEF	1.088	27.64	.435	11.05	.405	10.29	2.031	51.59	-	-
10SL	5/8-24 UNEF	5/8-24UNEF	1.088	27.64	.443*	11.25*	.405	10.29	2.031	51.59	-	-
12	3/4-20 UNEF	3/4-20UNEF	1.213	30.81	.550	13.97	.549	13.94	2.125	53.98	-	-
12S	3/4-20 UNEF	3/4-20UNEF	1.213	30.81	.550	13.97	.549	13.94	2.031	51.59	-	-
14	7/8-20 UNEF	7/8-20UNEF	1.358	34.49	.670	17.02	.665	16.89	2.125	53.98	-	-
14S	7/8-20 UNEF	7/8-20UNEF	1.358	34.49	.670	17.02	.665	16.89	2.031	51.59	-	-
16	1-20 UNEF	1-20UNEF	1.463	37.16	.800	20.32	.790	20.07	2.125	53.98	2.500	63.50
16S	1-20 UNEF	1-20UNEF	1.463	37.16	.800	20.32	.790	20.07	2.031	51.59	-	-
18	1 1/8-18 UNEF	1-1/16-18UNEF	1.588	40.34	.925	23.50	.869	22.07	2.125	53.98	2.500	63.50
20	1 1/4-18 UNEF	1-3/16-18UNEF	1.713	43.51	1.045	26.54	.994	25.25	2.125	53.98	2.500	63.50
22	1 3/8-18 UNEF	1-5/16-18UNEF	1.788	45.42	1.170	29.72	1.119	28.42	2.125	53.98	2.500	63.50
24	1 1/2-18 UNEF	1-7/16-18UNEF	1.963	49.86	1.295	32.89	1.244	31.60	2.125	53.98	2.500	63.50
28	1 3/4-18 UNS	1-3/4-18UNS	2.213	56.21	1.515	38.48	1.465	37.21	2.125	53.98	2.500	63.50
32	2-18 UNS	2-18UNS	2.463	62.56	1.765	44.83	1.715	43.56	2.125	53.98	2.500	63.50
36	2 1/4-16 UN	2-1/4-16UN	2.713	68.91	1.975	50.17	1.930	49.02	2.125	53.98	2.500	63.50
40	2 1/2-16 UN	2-1/2-16UN	2.963	75.26	2.225	56.52	2.145	54.48	2.125	53.98	2.500	63.50

* Tolerance for this dimension is $\pm .003(.08)$



MIL-DTL-5015 Series III, Rear Release Flange and Jam Nut Receptacles Panel Cutouts

Panel Cutouts

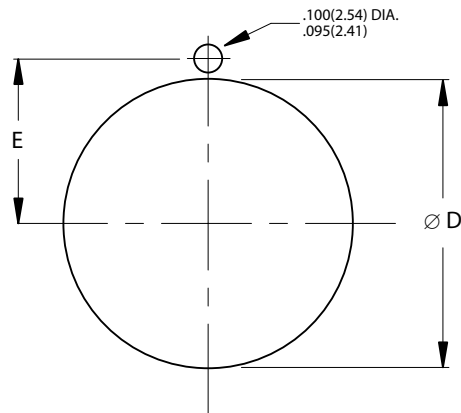
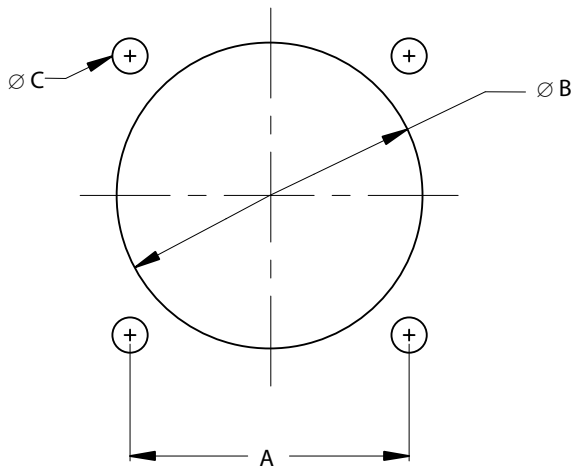

MS3454 (AE554) CUTOUT

5015 S III

Flange and Jam Nut Mounting Dimensions

Shell Size	A		Ø B		Ø C				Ø D		E	
	(TP)		±.010	±.25	Classes L, LS, W		Classes KS, KT		+.015	+.38	±.005	±.13
	inch	mm	inch	mm	inch	mm	inch	mm	inch	mm		
8S	.594	15.09	.562	14.27	.120	3.05	.150	3.81	.505	12.83	.323	8.20
10S, 10SL	.719	18.26	.688	17.48	.120	3.05	.150	3.81	.630	16.00	.385	9.78
12, 12S	.812	20.62	.812	20.62	.120	3.05	.150	3.81	.755	19.18	.448	11.38
14, 14S	.906	23.01	.938	23.83	.120	3.05	.150	3.81	.880	22.35	.510	12.95
16, 16S	.969	24.61	1.062	26.97	.120	3.05	.150	3.81	1.005	25.53	.573	14.55
18	1.062	26.97	1.188	30.18	.120	3.05	.177	4.50	1.130	28.70	.635	16.13
20	1.156	29.36	1.312	33.32	.120	3.05	.177	4.50	1.255	31.88	.698	17.73
22	1.250	31.75	1.438	36.53	.120	3.05	.177	4.50	1.380	35.05	.760	19.30
24	1.375	34.93	1.562	39.67	.147	3.73	.177	4.50	1.505	38.23	.823	20.90
28	1.562	39.67	1.812	46.02	.147	3.73	.177	4.50	1.755	44.58	.948	24.08
32	1.750	44.45	2.062	52.37	.173	4.39	.209	5.31	2.005	50.93	1.073	27.25
36	1.938	49.23	2.312	58.72	.173	4.39	.209	5.31	2.255	57.28	1.198	30.43
40	2.188	55.58	2.562	65.07	.173	4.39	.209	5.31	2.505	63.63	1.323	33.60

MS25042
Protective Cover, PLUG
AE542



Protective Cover, Plug

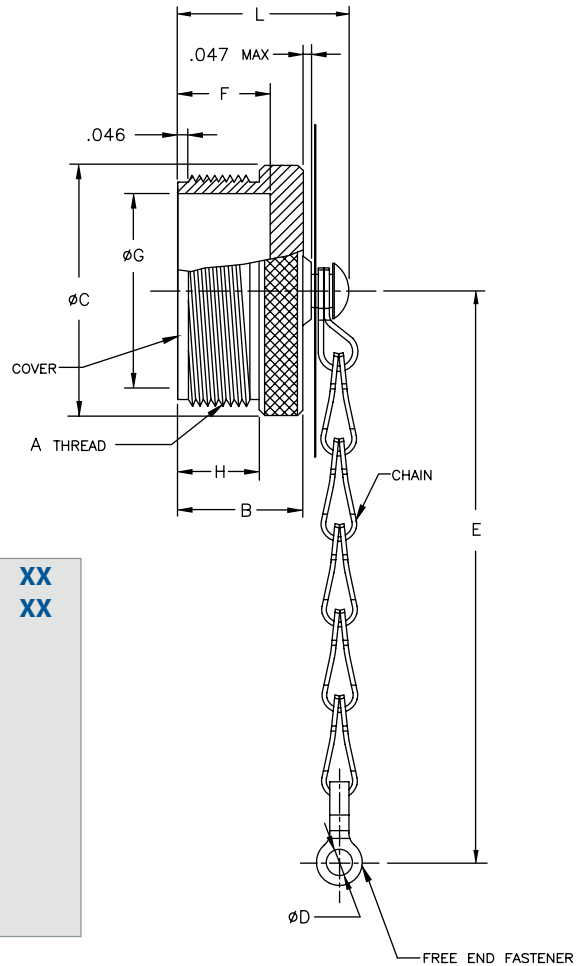

Part Number Configuration

MIL. Prefix	MS25042-	XX	XX
Aero Prefix	AE542-	XX	XX
Shell Size			
8 THRU 44 (Note: single digit for shell size 8)			
Material Finish			
DA = Aluminum, Hard Black Anodize			
D = Aluminum, Cadmium Olive Drab			
L = Aluminum, Electroless Nickel Plate			
LS = Stainless Steel, Passivated			
KT = Carbon Steel, Cadmium Olive Drab			
BN = Aluminum, Black Nickel Plate			
BZ = Bronze			

SHELL SIZE	Coupling Shell Size	A Thread Class 2A	B Max.	ØC Max.	ØD +.010 -0.005	E ±1 Link	F .016	ØG .016	H Min.	L Max.
8	8S	.500-28 UNEF	.656	.562	.156	4.000	.562	.375	.380	.969
10	10S, 10SL	.625-24 UNEF	.844	.687	.156	4.000	.562	.469	.380	.969
12	12, 12S	.750-20 UNEF	.844	.812	.156	4.500	.750	.562	.530	1.156
14	14, 14S	.875-20 UNEF	.844	0.937	.156	4.500	.750	.688	.530	1.156
16	16, 16S	1.000-20 UNEF	.844	1.062	.156	4.500	.750	.812	.530	1.156
18	18	1.125-18 UNEF	.844	1.187	.156	4.500	.750	.938	.530	1.156
20	20	1.250-18 UNEF	.844	1.312	.187	5.000	.750	1.062	.530	1.156
22	22	1.375-18 UNEF	.844	1.437	.187	5.000	.750	1.188	.530	1.156
24	24	1.500-18 UNEF	.844	1.562	.187	5.500	.750	1.312	.530	1.156
28	28	1.750-18 UNS	.844	1.812	.187	7.750	.750	1.531	.530	1.156
32	32	2.000-18UNS	.844	2.062	.218	7.750	.750	1.781	.530	1.156
36	36	2.250-16 UN	.844	2.312	.218	7.750	.750	2.000	.530	1.156
40	40	2.500-16 UN	.844	2.562	.218	7.750	.750	2.250	.530	1.156
44	44	2.750-16 UN	.844	2.812	.218	7.750	.750	2.500	.590	1.156

5015 S III



MS25043
Protective Cover, Receptacle
AE543

Protective Cover, Receptacle

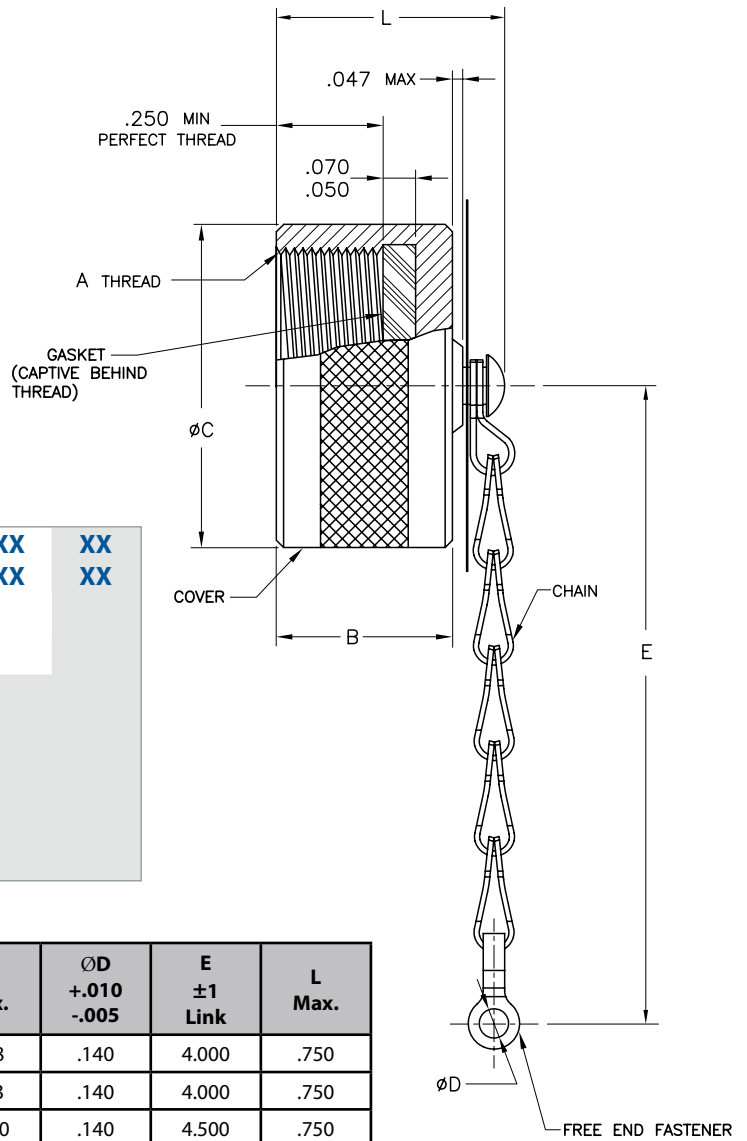

Part Number Configuration

MIL. Prefix	MS25043-	XX	XX
Aero Prefix	AE543-	XX	XX
Shell Size	8 THRU 44 (Note: single digit for shell size 8)		
Material Finish	<ul style="list-style-type: none"> DA = Aluminum, Hard Black Anodize D = Aluminum, Cadmium Olive Drab L = Aluminum, Electroless Nickel Plate LS = Stainless Steel, Passivated KT = Carbon Steel, Cadmium Olive Drab BN = Aluminum, Black Nickel Plate BZ = Bronze 		

SHELL SIZE	Coupling Shell Size	A Thread Class 2B	B Max.	ØC Max.	ØD +.010 -0.005	E ±1 Link	L Max.
8	8S	.500-28 UNEF	.469	.688	.140	4.000	.750
10	10S, 10SL	.625-24 UNEF	.469	.813	.140	4.000	.750
12	12, 12S	.750-20 UNEF	.469	1.000	.140	4.500	.750
14	14, 14S	.875-20 UNEF	.469	1.125	.140	4.500	.750
16	16, 16S	1.000-20 UNEF	.469	1.188	.140	4.500	.750
18	18	1.125-18 UNEF	.469	1.344	.140	4.500	.750
20	20	1.250-18 UNEF	.469	1.469	.140	5.000	.750
22	22	1.375-18 UNEF	.469	1.594	.140	5.000	.750
24	24	1.500-18 UNEF	.469	1.719	.171	5.500	.750
28	28	1.750-18 UNS	.531	1.969	.171	7.750	.812
32	32	2.000-18UNS	.531	2.219	.187	7.750	.812
36	36	2.250-16 UN	.531	2.469	.187	7.750	.812
40	40	2.500-16 UN	.531	2.718	.187	7.750	.812
44	44	2.750-16 UN	.531	2.969	.187	7.750	.812

5015 S III

MIL-DTL-5015 series III/AS50151
Contacts, Tools and Seal Plugs
MS345*/AE55*



Contacts, Plastic Insertion/Removal Tools and Seal Plugs

Contact Size	Application	Pin Contacts	Socket Contacts	Seal Plugs	Insertion/Removal Tools
	Type	Military No.	Military No.	Military No.	Military No.
					Plastic
16S	Power/Signal	N/A	M39029/30-217	MS27488-16-1	M81969/14-03
16	Power/Signal	M39029/29-212	M39029/30-218		
12	Power/Signal	M39029/29-213	M39029/30-219	MS27488-12-1	M81969/14-04
8	Power	M39029/29-214*	M39029/30-220*	MS27488-8-1	M81969/14-06
4	Power	M39029/29-215*	M39029/30-221*	MS27488-4-1**	M81969/14-07
0	Power	M39029/29-216*	M39029/30-222*	MS27488-0-1**	M81969/14-08

* No spare size 0, 4 and 8 contacts are provided in connector contact packages.

** Not supplied as part of connector contact packages.

Crimping and Metal Insertion/Extraction Tools

Contact Size	Crimp Tool	Positioner	Die Set	Locator	Extraction Tool
		Pin & Socket Contacts	Pin & Socket Contacts	Pin & Socket Contacts	Metal
	Military No.	Military No.	Military No.	Military No.	Military No.
16/16S	M22520/1-01	M22520/1-02	N/A	N/A	M81969/8-208
12	M22520/1-01	M22520/1-02	N/A	N/A	M81969/8-210
8	M22520/23-01	N/A	M22520/23-02	M22520/23-09	M81969/15-01
4	M22520/23-01	N/A	M22520/23-03	M22520/23-11	M81969/15-02
0	M22520/23-01	N/A	M22520/23-04	M22520/23-13	M81969/15-03

Contact and Wire Data

Contact Size	Test Current	Voltage	Crimp Well Data			Wire Range		Finished Wire ϕ Range			
	DC Test	Max. Drop	Well Dia.	Minimum Well Dept		AWG	mm ²	Minimum		Maximum	
	Amps	Millivolts	inch	inch	mm			inch	mm	inch	mm
16/16S	13	49	.067 ±.001	.250	6.35	20-16	0.52-1.31	.053	1.35	.103	2.62
12	23	42	.100 ±.002	.250	6.35	14-12	2.08-3.31	.085	2.16	.158	4.01
8	46	26	.181 ±.002	.485	12.32	10-8†	5.26-8.37	.132	3.35	.255	6.48
4	80	23	.281 ±.002	.485	12.32	6-4†	13.30-21.15	.237	6.02	.370	9.40
0	150	21	.453 ±.002	.580	14.73	2-0†	33.63-53.48	.360	9.14	.550	13.97

† MS3348 bushings required in crimp barrel to accommodate 10, 6 and 2 wire gauges. Bushings are ordered separately.

Note 1: 16S socket contacts are only used in shell sizes 8S, 10S, 10SL, 12S, 14S and 16S.

Note 2: Test Current and Maximum Voltage Drop when tested with silver-plated wire at 25°C.

Note 3: Metal Insertion tool is not req'd for size 8, 4 and 0 contacts. Metal insertion tool for size 16 contacts = M81969/8-207. Metal insertion tool for size 12 contacts = M81969/8-209.

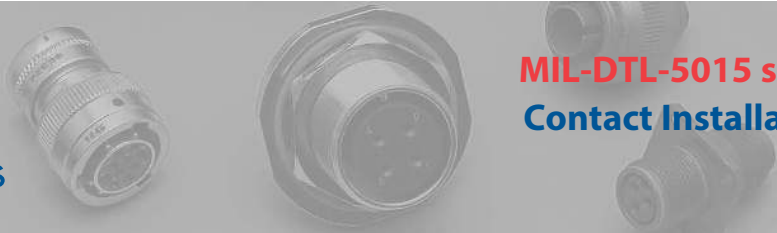

MIL-DTL-5015 series III/AS50151
Contact Installation Instructions
MS345*/AE55*

Contact Installation Instructions

Crimping Contacts

1. Select the appropriate crimp tool and ensure that the proper crimp head positioner is used.
2. Cycle the tool to be sure the indentors are open.
3. Determine the correct selector setting for the wire size from the data plate on the positioner (turret head assembly) and set the selector knob on the crimp tool to match.
4. Place the contact, mating end first, into the tool.
5. Insert the stripped wire into the hollow end of the contact. Be sure the wire is inserted as far as it will go.
6. Close the tool completely to crimp. Unless the tool is closed completely, the tool will not release the contact.
7. Remove the crimped contact from the tool. Check the inspection hole to verify that the wire is fully inserted.

Insertion of Contacts

1. Before inserting the contacts, unscrew the accessories (clamps, backshells or adapters) from rear of plug or receptacle. Slide the hardware over the wire bundle in the proper order for reassembly after all the contacts are inserted.
2. To assist insertion of contacts, lubricate insulator (grommet) cavities with isopropyl alcohol. Alcohol will evaporate and will not leave a conductive film. **Caution: Never use any lubricant other than isopropyl alcohol.**

3. Place the correct insertion tool on the contact so that the wire runs along the groove in the tool. (Tool tip will butt against the shoulder.) Hold the plug or receptacle body firmly.
4. Beginning with a center cavity, insert the contact into the insulator with a slow, even pressure until the contact snaps into position. Make sure the contact and tool are held perpendicular to the face of the insert during the contact installation or the grommet could be damaged.
 - 4.1 If contacts are not inserted all the way prior to removing insertion tool, do not try to reinsert the insertion tool. Instead, remove the contact and try again; otherwise reinserting the insertion tool may damage the inside of the contact cavity.
5. Remove tool and check the face of the connector for proper contact installation. Proper installation may also be checked by pulling back lightly on the wire to make sure the contact is properly seated.

Completion

After all the cavities have been filled, slide the hardware back into position on the connector and tighten.

Extraction of Contacts (Rework)

1. Slide the hardware back over the wire bundle.
2. Select the appropriate tool. Place the wire into the extraction tool of the pin or socket.
3. Slowly slide the extraction tool down wire into the contact cavities until the tool tip bottoms against the contact shoulder, expanding the clip retaining tines. Hold the wire firmly in the tool and pull the wired contact and tool straight out of the rear of the insulator.

Size	Pin Contact	Socket Contact	Crimp Tool	Positioner	Die Set	Locator	I/R Tool
16S*	—	M39029/30-217	M22520/1-01	M22520/1-02 Blue	—	—	M81969/14-03
16	M39029/29-212	M39029/30-218	M22520/1-01	M22520/1-02 Blue	—	—	M81969/14-03
12	M39029/29-213	M39029/30-219	M22520/1-01	M22520/1-02 Yellow	—	—	M81969/14-04
8	M39029/29-214	M39029/30-220	M22520/23-01	—	M22520/23-02	M22520/23-09	M81969/14-06
4	M39029/29-215	M39029/30-221	M22520/23-01	—	M22520/23-04	M22520/23-11	M81969/14-07
0	M39029/29-216	M39029/30-222	M22520/23-01	—	M22520/23-05	M22520/23-13	M81969/14-08

I/R = Insertion/Removal

* 16S socket contact is only used in shell sizes 8S, 10S, 10SL, 12S, 14S and 16S.

MIL-DTL-5015 series III/AS50151

Polarization, Insert Availability & Contact Information per MIL-STD-1651



Polarization (Insert Clocking)

1. In the normal insert clocking position (position N), the insert centerline coincides with the centerline of the master keyway (key) of the shell: $L = 0^\circ$.
2. In the alternate clocking positions (W, X, Y and Z), the pin insert (viewing from mating side) is rotated clockwise relative to the centerline of the master keyway (key) of the shell.
3. The socket insert is rotated counter-clockwise.
4. Plugs have keyways; receptacles have keys.

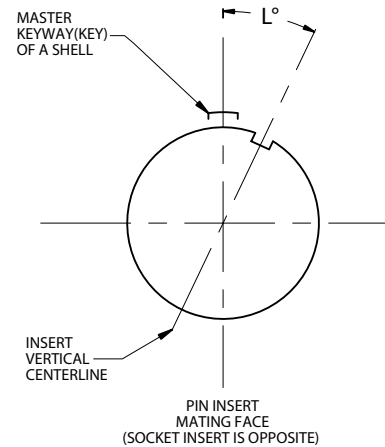

Note: Be careful with alternate positions. See table below for position availability on layouts of interest.

Insert Availability, Contact Information and Clocking Positions

Shell Size & Insert Arrangement	Aero-Electric		Contacts			Service Rating	Contact Location	Insert Positions				
	Status		Total Number	Quantity by Size				"L" Degrees				
	QPL'd	Tooled		Qty	Size			N	W	X	Y	Z
8S-1	Yes	Yes	1	1	16/16S**	A	All	0	—	—	—	—
10S-2	Yes	Yes	1	1	16/16S**	A	All	0	—	—	—	—
10SL-3***	Yes	Yes	3	3	16/16S**	A	All	0	—	—	—	—
10SL-4	Yes	Yes	2	2	16/16S**	A	All	0	—	—	—	—
12-5	Yes	Yes	1	1	12	D	All	0	—	—	—	—
12S-3	Yes	Yes	2	2	16/16S**	A	All	0	70	145	215	290
12S-4	Yes	Yes	1	1	16/16S**	D	All	0	—	—	—	—
14-3	Yes	Yes	1	1	8	A	All	0	—	—	—	—
14S-1*	Yes	Yes	3	3	16/16S**	A	All	0	—	—	—	—
14S-2	Yes	Yes	4	4	16/16S**	Inst.	All	0	—	120	240	—
14S-5	Yes	Yes	5	5	16/16S**	Inst.	All	0	—	110	—	—
14S-6	Yes	Yes	6	6	16/16S**	Inst.	All	0	—	—	—	—
14S-7	Yes	Yes	3	3	16/16S**	A	All	0	90	180	270	—
14S-9*	Yes	Yes	2	2	16/16S**	A	All	0	70	145	215	290
16-10	Yes	Yes	3	3	12	A	All	0	90	180	270	—
16-11	Yes	Yes	2	2	12	A	All	0	35	110	250	325
16-12	Yes	Yes	1	1	4	A	All	0	—	—	—	—
16S-1	Yes	Yes	7	7	16/16S**	A	All	0	80	—	—	280
16S-4	Yes	Yes	2	2	16/16S**	D	All	0	35	110	250	325
16S-5*	Yes	Yes	3	3	16/16S**	A	All	0	70	145	215	290
16S-8	Yes	Yes	5	5	16/16S**	A	All	0	—	170	265	—

* Inactive for new design

** Pin contact is size 16, socket contact is size 16S

*** Service Rating = Inst. for classes KS and KT only.



MIL-DTL-5015 series III/AS5015
Insert Availability, Contact Information and Clocking
per MIL-STD-1651

Insert Availability, Contact Information and Clocking Positions

Shell Size & Insert Arrangement	Aero-Electric		Contacts				Service Rating	Contact Location	Insert Positions				
	Status		Total Number	Quantity by Size		Contact			"L" Degrees				
	QPL'd	Tooled		Qty	Size				N	W	X	Y	Z
18-1	Yes	Yes	10	4	16	A	B,C,F,G	0	70	145	215	290	
				6	16	Inst.	All others						
18-4	Yes	Yes	4	4	16	D	All	0	35	110	250	325	
18-5	Yes	Yes	3	1	16	D	All	0	80	110	250	280	
				2	12								
18-6	Yes	Yes	1	1	4	D	—	0	—	—	—	—	
18-8	Yes	Yes	8	7	16	A	All	0	70	—	—	290	
				1	12								
18-9	Yes	Yes	7	5	16	Inst.	All	0	80	110	250	280	
				2	12								
18-10*	Yes	Yes	4	4	12	A	All	0	—	120	240	—	
18-11	Yes	Yes	5	5	12	A	All	0	—	170	265	—	
18-12	Yes	Yes	6	6	16	A	All	0	80	—	—	280	
18-20*	Yes	Yes	5	5	16	A	All	0	90	180	270	—	
20-2	Yes	Yes	1	1	0	D	---	0	—	—	—	—	
20-3*	Yes	Yes	3	3	12	D	All	0	70	145	215	290	
20-4	Yes	Yes	4	4	12	D	All	0	45	110	250	—	
20-7	Yes	Yes	8	4	16	D	A,B,G,H	0	80	110	250	280	
				4	16	A	All others						
20-8	Yes	Yes	6	4	16	Inst.	All	0	80	110	250	280	
				2	8								
20-11*	Yes	Yes	13	13	16	Inst.	All	0	—	—	—	—	
20-14	Yes	No	5	3	12	A	All	0	80	110	250	280	
				2	8								
20-15	Yes	Yes	7	7	12	A	All	0	80	—	—	280	
20-16	Yes	Yes	9	7	16	A	All	0	80	110	250	280	
				2	12								
20-17	Yes	Yes	6	1	16	A	All	0	90	180	270	—	
				5	12								
20-18	Yes	Yes	9	6	16	A	All	0	35	110	250	325	
				3	12								
20-22	Yes	Yes	6	3	16	A	All	0	80	110	250	280	
				3	8								
20-24*	Yes	Yes	4	2	16	A	All	0	35	110	250	325	
				2	8								
20-27	Yes	Yes	14	14	16	A	All	0	35	110	250	325	
20-29	Yes	Yes	17	17	16	A	All	0	80	—	—	280	
20-33	Yes	Yes	11	11	16	A	All	0	—	—	—	—	
22-1*	Yes	Yes	2	2	8	D	All	0	35	110	250	325	

5015 S III

* Inactive for new design

MIL-DTL-5015 series III/AS50151

Insert Availability, Contact Information and Clocking per MIL-STD-1651



Insert Availability, Contact Information and Clocking Positions

Shell Size & Insert Arrangement	Aero-Electric		Contacts				Service Rating	Contact Location	Insert Positions				
	Status		Total Number	Quantity by Size		Contact			"L" Degrees				
	QPL'd	Tooled		Qty	Size				N	W	X	Y	Z
22-2	Yes	Yes	3	3	8	D	All	0	70	145	215	290	
22-9	Yes	Yes	3	3	12	E	All	0	70	145	215	290	
22-12	Yes	Yes	5	3	16	D	All	0	80	110	250	280	
				2	8								
22-13*	Yes	Yes	5	1	16	D	E	0	35	110	250	325	
				4	12	A	All others						
22-14**	Yes	Yes	19	19	16	A	All	0	80	110	250	280	
22-18	Yes	Yes	8	3	16	A	C,D,E	0	80	110	250	280	
				5	16	D	All others						
22-19	Yes	Yes	14	14	16	A	All	0	80	110	250	280	
22-20*	Yes	Yes	9	9	16	A	All	0	35	110	250	325	
22-22	Yes	Yes	4	4	8	A	All	0	—	110	250	—	
22-23	Yes	Yes	8	1	12	D	H	0	35	—	250	—	
				7	12	A	All others						
22-27	Yes	Yes	9	1	8	D	J	0	80	—	250	280	
				8	16	A	All others						
22-33*	Yes	Yes	7	3	16	A	E,F,G	0	80	110	250	280	
				4	16	D	All others						
24-2	Yes	Yes	7	7	12	D	All	0	80	—	—	280	
24-4	Yes	Yes	4	3	16	D	All	0	80	110	250	280	
				1	0								
24-6	Yes	Yes	8	3	12	D	A,G,H	0	80	110	250	280	
				5	12	A	All others						
24-7	Yes	Yes	16	14	16	A	All	0	80	110	250	280	
				2	12								
24-9*	Yes	Yes	2	2	4	A	All	0	35	110	250	325	
24-10	Yes	Yes	7	7	8	A	All	0	80	—	—	280	
24-11	Yes	Yes	9	6	12	A	All	0	35	110	250	325	
				3	8								
24-12	Yes	Yes	5	3	12	A	All	0	80	110	250	280	
				2	4								
24-20	Yes	Yes	11	9	16	D	All	0	80	110	250	280	
				2	12								
24-21	Yes	No	10	9	16	D	All	0	80	110	250	280	
				1	8								
24-22	Yes	Yes	4	4	8	D	All	0	45	110	250	—	
24-27	Yes	Yes	7	7	16	E	All	0	80	—	—	280	
24-28	Yes	Yes	24	24	16	Inst.	All	0	80	110	250	280	

* Inactive for new design

** Alternate positions X, Y are cancelled after June 26, 1968.

5015 S III



MIL-DTL-5015 series III/AS5015
Insert Availability, Contact Information and Clocking
per MIL-STD-1651

Insert Availability, Contact Information and Clocking Positions

Shell Size & Insert Arrangement	Aero-Electric		Contacts			Service Rating	Contact Location	Insert Positions				
	Status		Total Number	Quantity by Size				"L" Degrees				
	QPL'd	Tooled		Qty	Size			N	W	X	Y	Z
28-1	Yes	Yes	9	2	12	D	A,E	0	80	110	250	280
				4	12	A	B,D,F,H					
				1	8	D	J					
				2	8	A	G,C					
28-2	Yes	Yes	14	12	16	D	All	0	35	110	250	325
				2	12							
28-3	Yes	Yes	3	3	8	E	All	0	70	145	215	290
28-5	Yes	Yes	5	2	16	D	All	0	35	110	250	325
				1	12							
				2	4							
28-8	Yes	Yes	12	2	12	E	L,M	0	80	110	250	280
				1	16	D	B					
				9	16	A	All others					
28-9	Yes	Yes	12	6	16	D	All	0	80	110	250	280
				6	12							
28-11	Yes	Yes	22	18	16	A	All	0	80	110	250	280
				4	12							
28-12	Yes	Yes	26	26	16	A	All	0	90	180	270	—
28-15	Yes	Yes	35	35	16	A	All	0	80	110	250	280
28-16*	Yes	Yes	20	20	16	A	All	0	80	110	250	280
28-19	Yes	Yes	10	2	16	B	H,M	0	80	110	250	280
				2	16	D	A,B					
				2	16	A	All others					
				4	12							
28-20	Yes	Yes	14	4	16	A	All	0	80	110	250	280
				10	12							
28-21	Yes	Yes	37	37	16	A	All	0	80	110	250	280
28-22	Yes	Yes	6	3	16	D	All	0	70	145	215	290
				3	4							
32-1	Yes	Yes	5	1	12	E	A	0	80	110	250	280
				2	12	D	D,C					
				2	0		B,E					
32-3	Yes	Yes	9	4	16	D	All	0	80	110	250	280
				2	12							
				2	4							
				1	0							
32-5*	Yes	Yes	2	2	0	D	All	0	80	110	250	325
32-6	Yes	Yes	23	16	16	A	All	0	80	110	250	280
				2	12							
				3	8							
				2	4							

* Inactive for new design

MIL-DTL-5015 series III/AS50151

Insert Availability, Contact Information and Clocking per MIL-STD-1651



Insert Availability, Contact Information and Clocking Positions

Shell Size & Insert Arrangement	Aero-Electric		Contacts			Service Rating	Contact Location	Insert Positions				
	Status		Total Number	Quantity by Size				"L" Degrees				
	QPL'd	Tooled		Qty	Size			N	W	X	Y	Z
32-7	Yes	Yes	35	4	16	Inst.	A,B,h,j	0	80	125	235	280
				24	16							
				7	12							
32-8*	Yes	Yes	30	24	16	A	All	0	80	125	235	280
				6	12							
32-10*	Yes	Yes	7	2	16	E	A,F	0	80	110	250	280
				1	16	B	G					
				2	8	D	B,E					
				2	4	A	C,D					
32-15	Yes	Yes	8	6	12	D	All	0	35	110	250	280
				2	0							
32-17	Yes	Yes	4	4	4	D	All	0	45	110	250	---
32-22**	Yes	Yes	54	54	16	A	All	0	80	110	250	280
32-63	Yes	Yes	5	5	4	D	All	0	—	—	—	—
32-73	Yes	Yes	46	46	16	A	All	0	36	—	—	—
36-3	Yes	No	6	3	12	D	All	0	70	145	215	290
				3	0							
36-5	Yes	Yes	4	4	0	A	All	0	—	120	240	—
36-6	Yes	Yes	6	4	4	A	All	0	35	110	250	325
				2	0							
36-7	Yes	Yes	47	40	16	A	All	0	80	110	250	280
				7	12							
36-8	Yes	Yes	47	46	16	A	All	0	80	110	250	280
				1	12							
36-9	Yes	Yes	31	14	16	A	All	0	80	125	235	280
				14	12							
				2	8							
				1	4							
36-10	Yes	Yes	48	48	16	A	All	0	80	125	235	280
40-10	Yes	Yes	29	16	16	A	All	0	65	125	225	310
				9	8							
				4	4							
40-56	Yes	Yes	85	85	16	A	All	0	72	144	216	288

* Inactive for new design

** Alternate positions U (100 degrees) and V (260 degrees) are also available per MIL-STD-1651.

5015 S III



Insert Arrangement Views

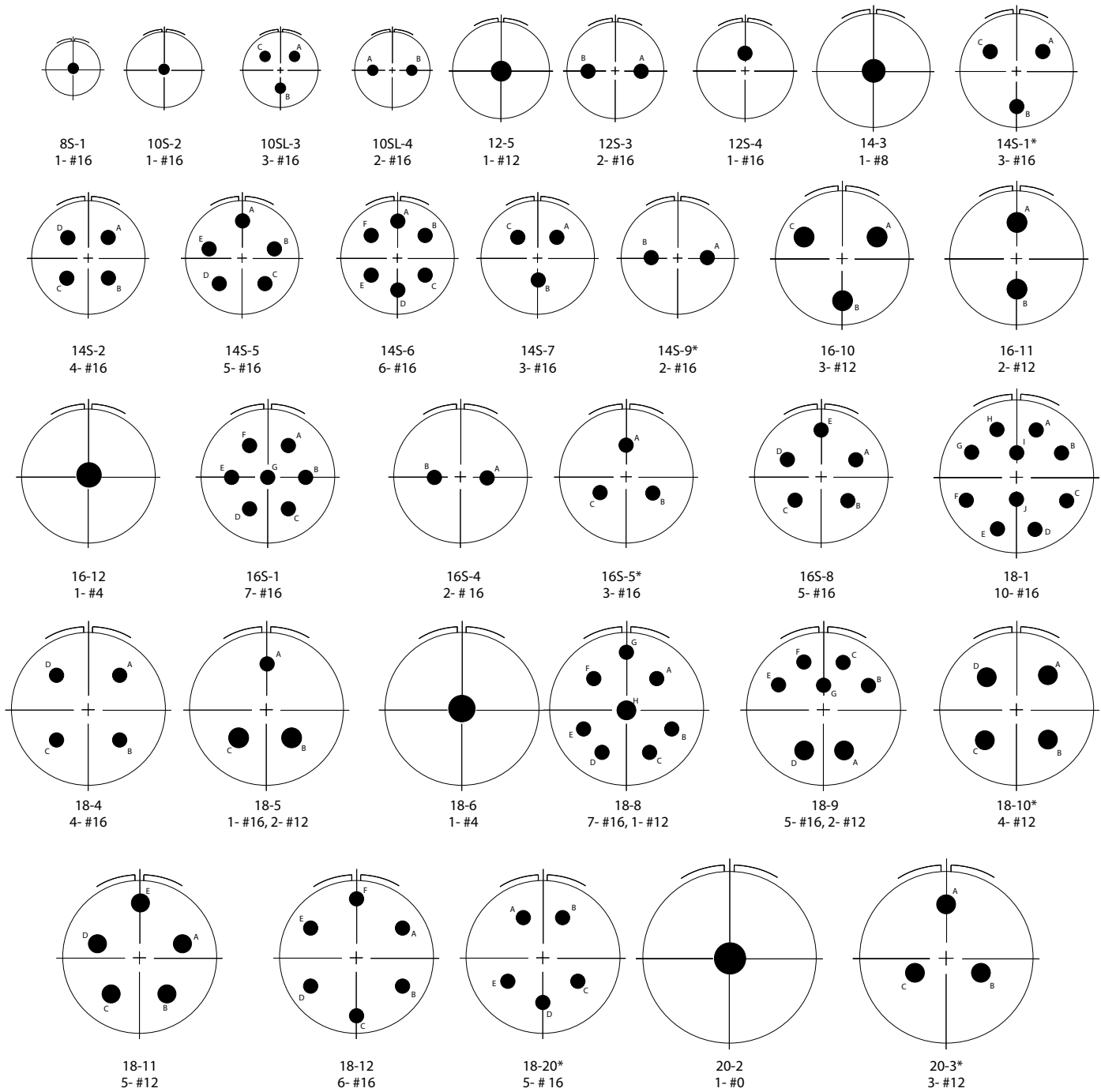

5015 S III

* Inactive for new design

MIL-STD-1651

Insert Arrangements (Pin Front View) for MIL-DTL-5015 Connectors



Insert Arrangement Views

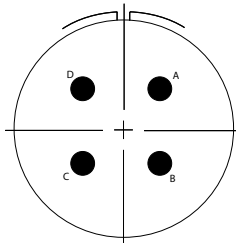

20-4
4- #12

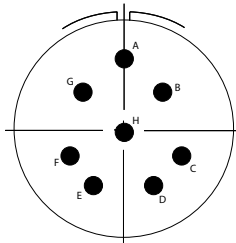

20-7
8- #16

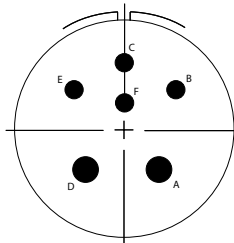

20-8
4- #16, 2- #8

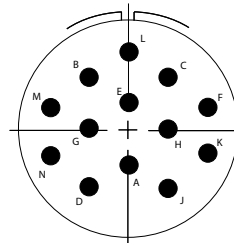

20-11*
13- #16

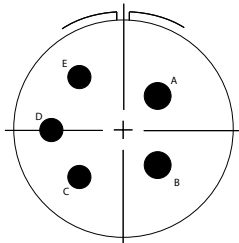

20-14
3- #12, 2- #8

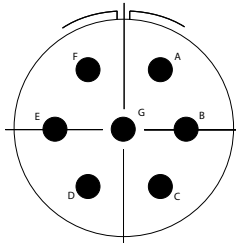

20-15
7- #12

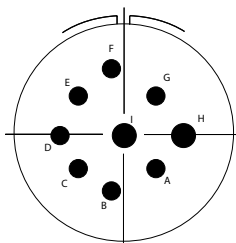

20-16
7- #16, 2- #12

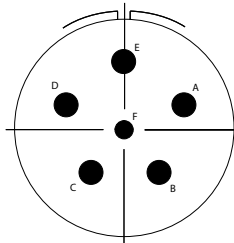

20-17
1- #16, 5- #12

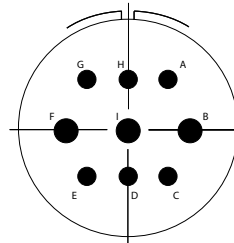

20-18
6- #16, 3- #12

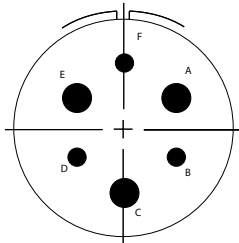

20-22
3- #16, 3- #8

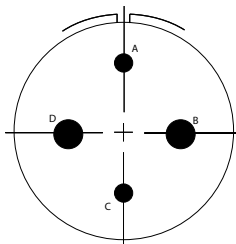

20-24*
2- #16, 2- #8

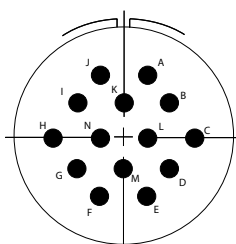

20-27
14- #16

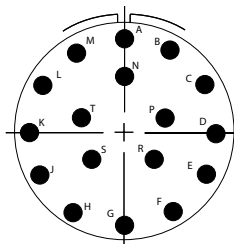

20-29
17- #16

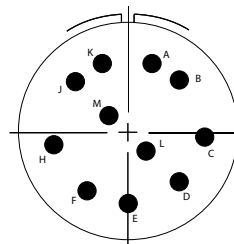

20-33
11- #16

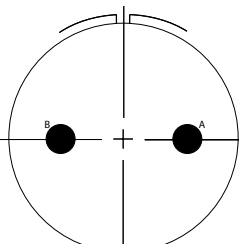

22-1*
2- #8

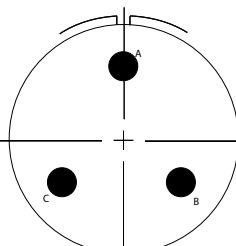

22-2
3- #8

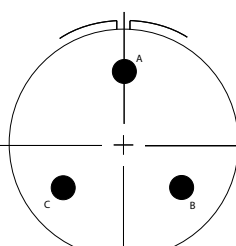

22-9
3- #12

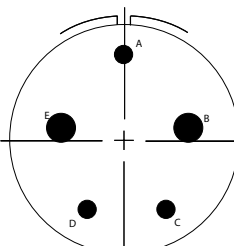

22-12
3- #16, 2- #8

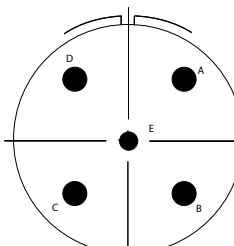

22-13*
1- #16, 4- #12

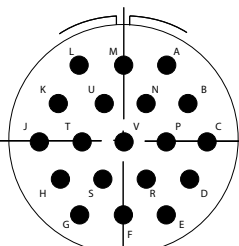

22-14
19- #16

* Inactive for new design

5015 S III



Insert Arrangement Views

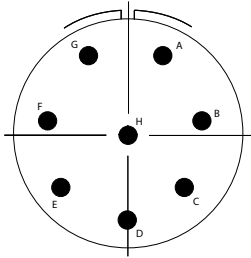

22-18
8- #16

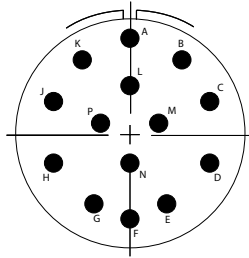

22-19
14- #16

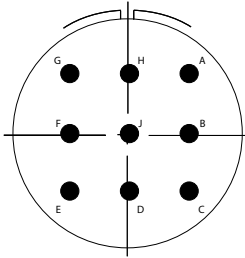

22-20*
9- #16

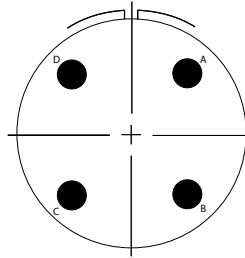

22-22
4- #8

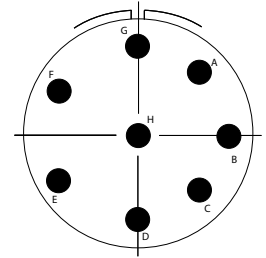

22-23
8- #12

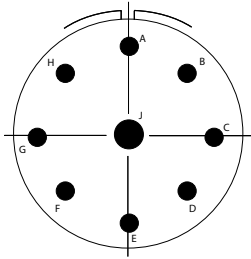

22-27
1- #8, 8- #16

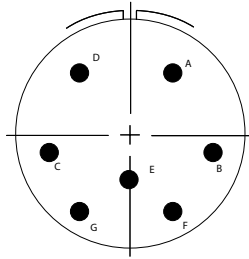

22-33*
7- #16

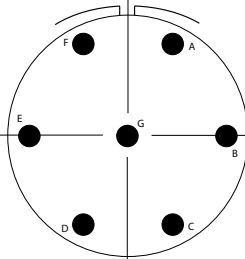

24-2
7- #12

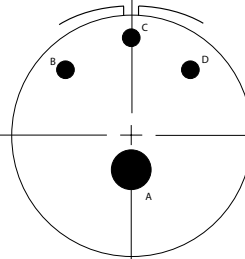

24-4
3- #16, 1- #0

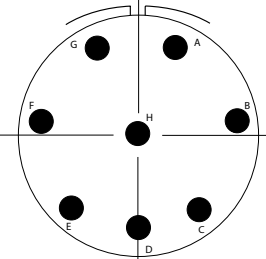

24-6
8- #12

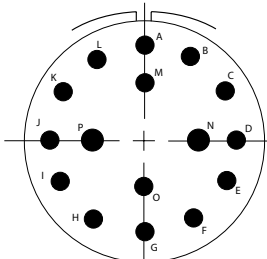

24-7
14- #16, 2- #12

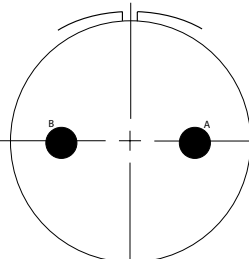

24-9*
2- #4

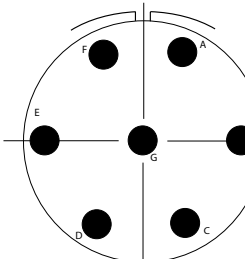

24-10
7- #8

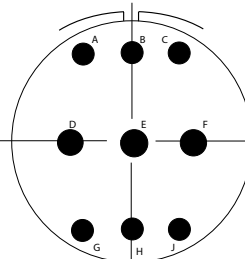

24-11
6- #12, 3- #8

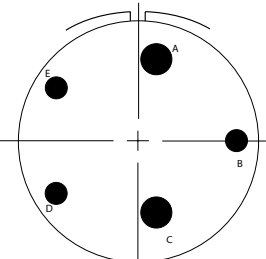

24-12
3- #12, 2- #4

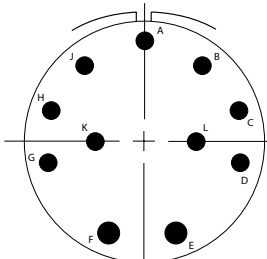

24-20
9- #16, 2- #12

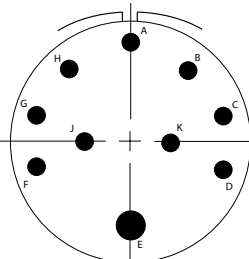

24-21
9- #16, 1- #8

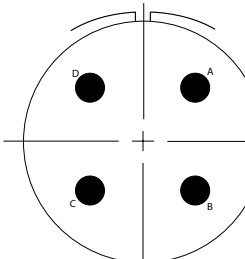

24-22
4- #8

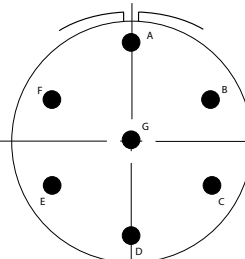

24-27
7- #16

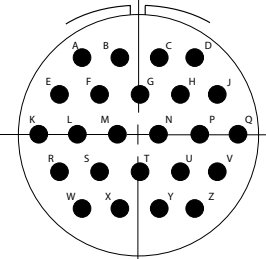

24-28
24- #16

5015 S III

* Inactive for new design

Insert Arrangement Views

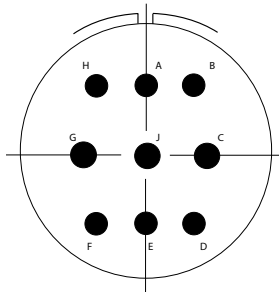

28-1
6- #12, 3- #8

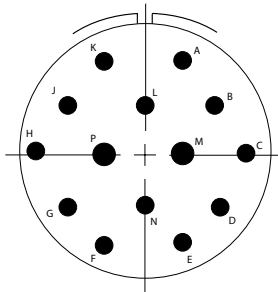

28-2
12- #16, 2- #12

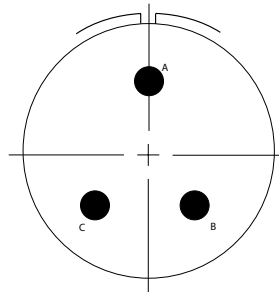

28-3
3- #8

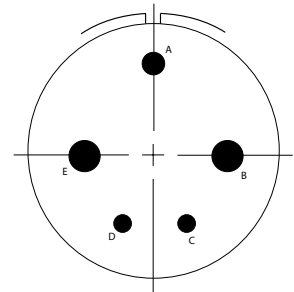

28-5
2- #16, 1- #12, 2- #4

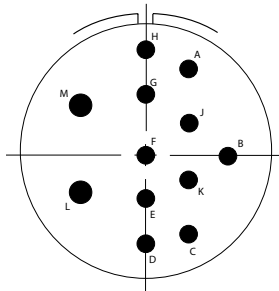

28-8
2- #12, 10- #16

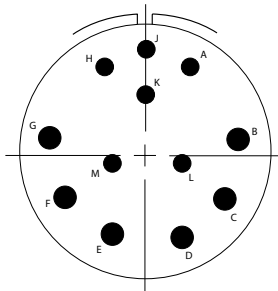

28-9
6- #16, 6- #12

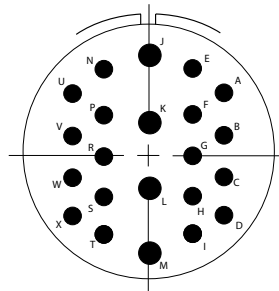

28-11
18- #16, 4- #12

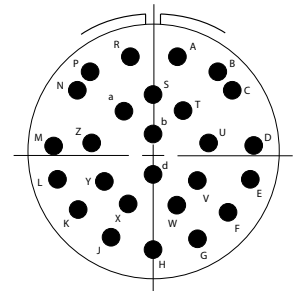

28-12
26- #16

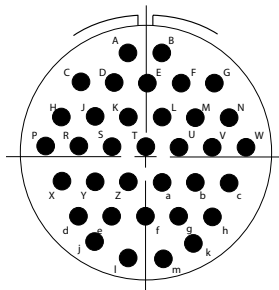

28-15
35- #16

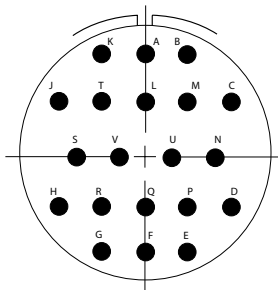

28-16*
20- #16

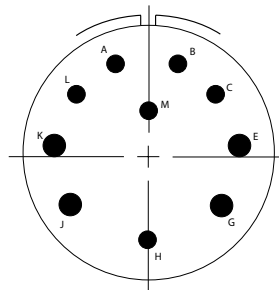

28-19
6- #16, 4- #12

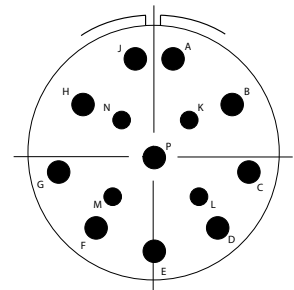

28-20
4- #16, 10- #12

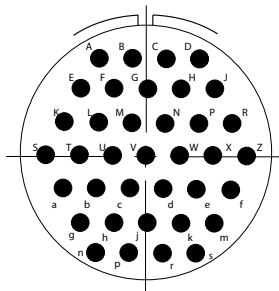

28-21
37- #16

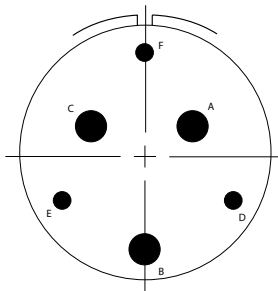

28-22
3- #16, 3- #4

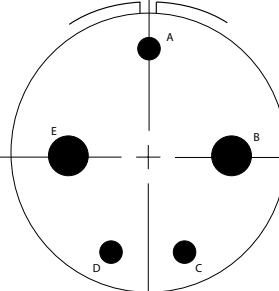

32-1
3- #12, 2- #0

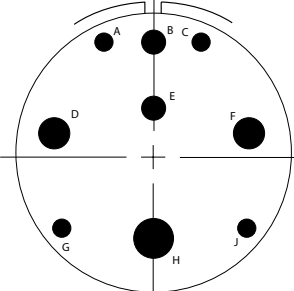

32-3
4- #16, 2- #12,
2- #4, 1- #0

* Inactive for new design

5015 S III



Insert Arrangement Views

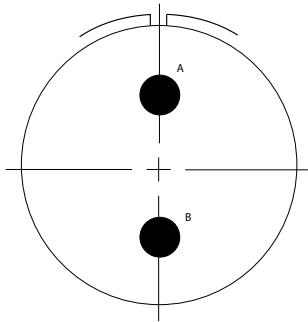

32-5*
2- #0

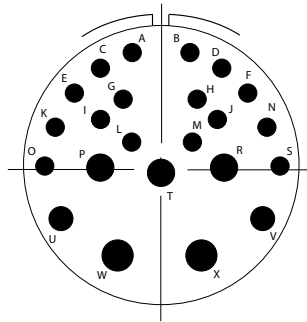

32-6
16- #16, 2- #12,
3- #8, 2- #4

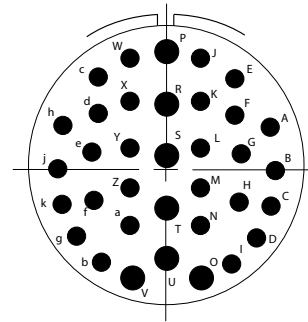

32-7
28- #16, 7- #12

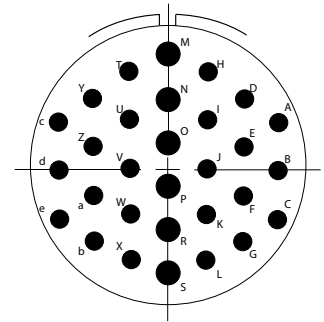

32-8*
24- #16, 6- #12

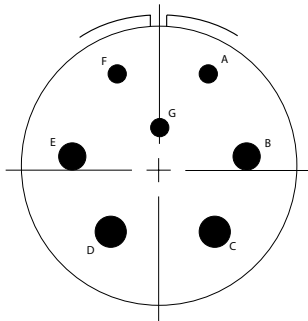

32-10*
3- #16, 2- #8,
2- #4

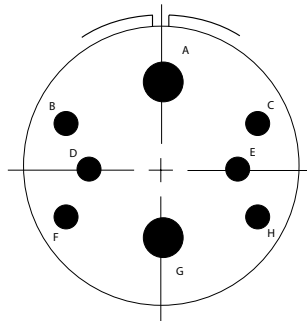

32-15
6- #12, 2- #0

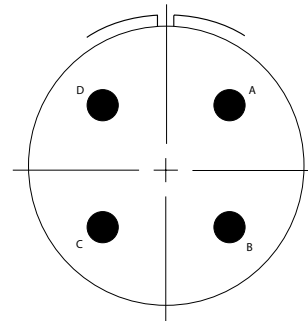

32-17
4- #4

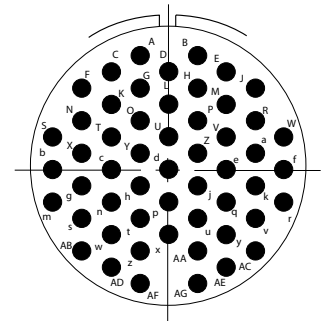

32-22
54- #16

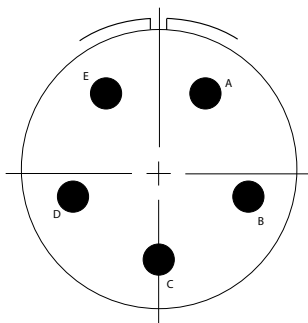

32-63
5- #4

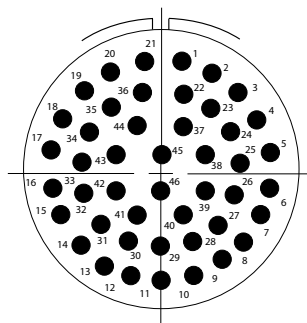

32-73
46- #16

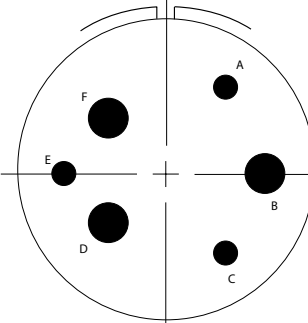

36-3
3- #12, 3- #0

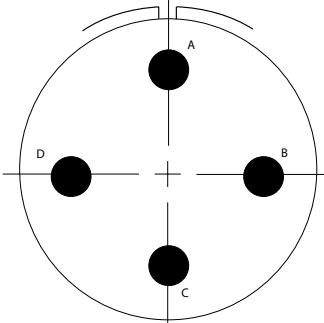

36-5
4- #0

5015 S III

* Inactive for new design

MIL-STD-1651

Insert Arrangements (Pin Front View) for MIL-DTL-5015 Connectors



Insert Arrangement Views

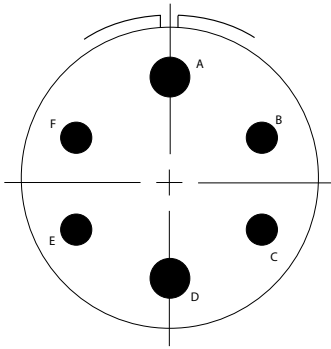

36-6
4- #4, 2- #0

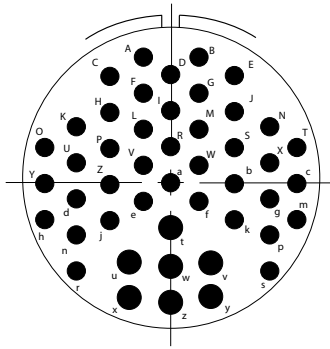

36-7
40- #16, 7- #12

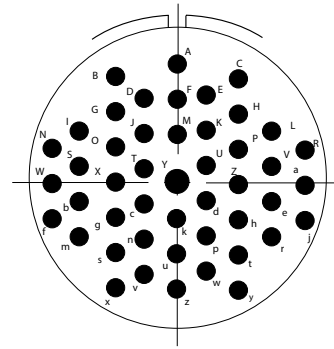

36-8
46- #16, 1- #12

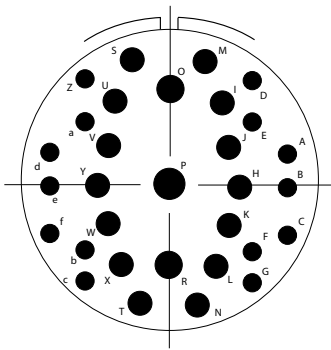

36-9
14- #16, 14- #12,
2- #8, 1- #4

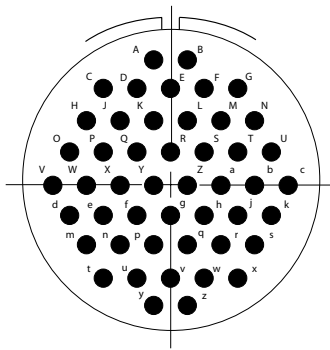

36-10
48- #16

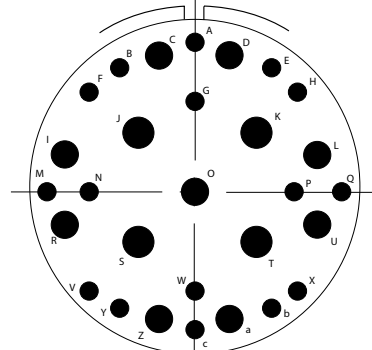

40-10
16- #16, 9- #8,
4- #4

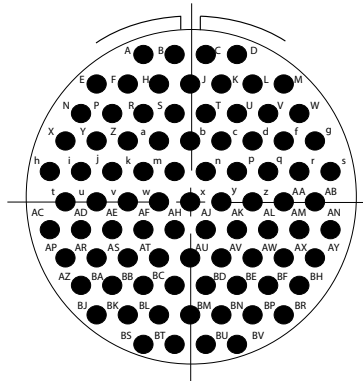

40-56
85- #16

5015 S III