



Conforms to EN60204-1, EN292, and EN692
UL and C-UL listed, CSA and BG approved



H
safety monitoring relays

SR125SMS Stop Motion Sensing Unit

- Power requirements—the SR125SMS will accept 24 VDC, 110 VAC, or 220 VAC
- Motion detection input—the SR125SMS detects the stop condition of all types of AC or DC motors by sensing the motor's back EMF across terminals Z1, Z2 and Z3
- Drive compatible—the SR125SMS will function with electronic motor control devices such as variable speed controllers, DC injection brakes, etc.
- Selectable speed limit—the SR125SMS has 1 N/O and 1 N/C outputs that are switched when motor speed reaches the adjustable preset limit (0.01 to 0.10 V) for the particular output
- Auxiliary output—the SR125SMS has 2 solid state auxiliary signaling outputs

A Go to the Engineering Guide
For in-depth information on safety standards and use.

■ Application

24VAC/DC, 110VAC, 230VAC

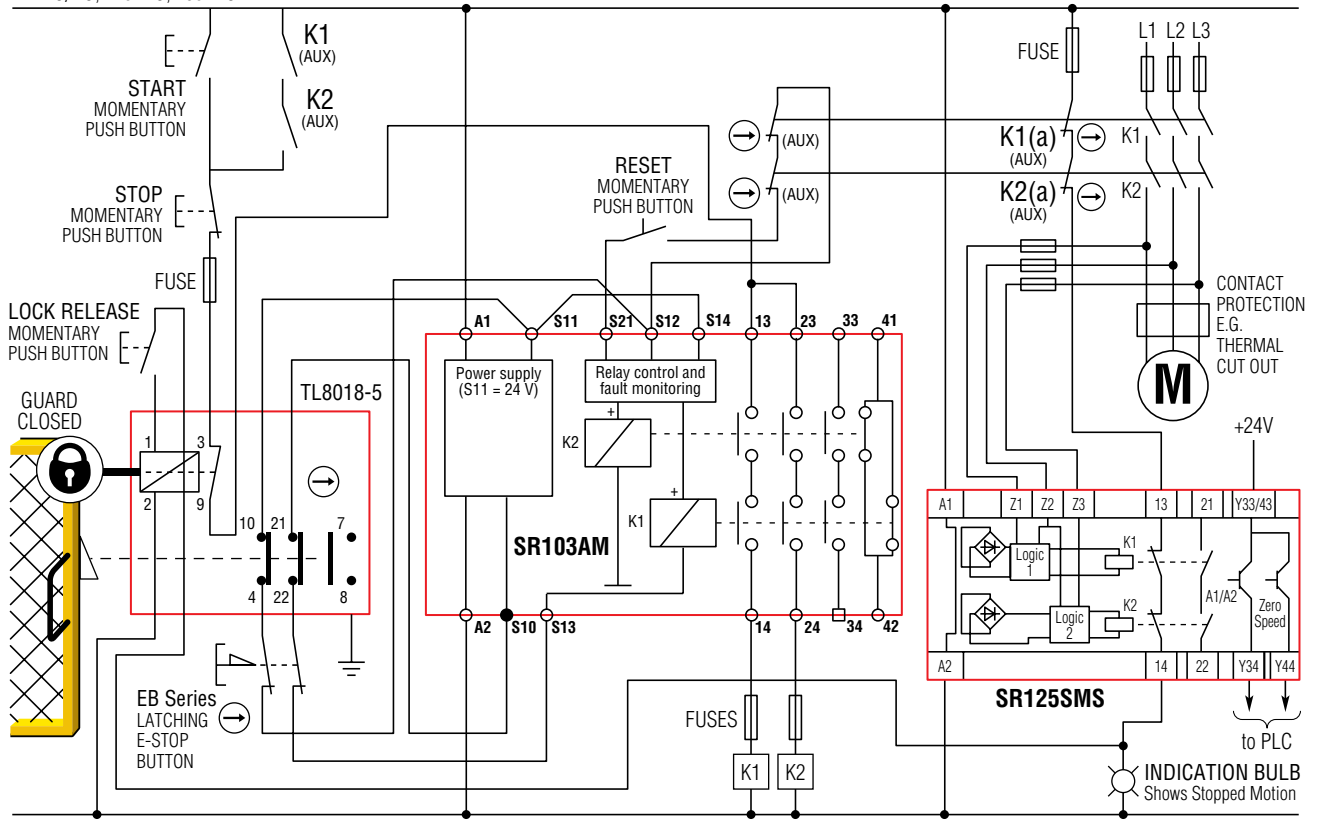

H
safety monitoring relays

For a full explanation of the circuit operating principle and fault detection, see "Common Circuit Examples" in the Engineering Section of this catalog.

Operation

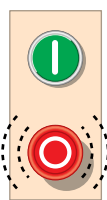

Stop signal to motor



SR125SMS detects back EMF of motor and senses when hazardous motion has ceased, then signals guard locking switch to unlock

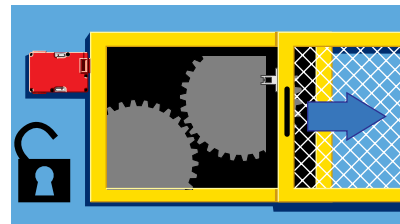
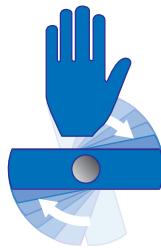

Guard locking switch unlocks guard allowing safe access to machine

Terminal Connections

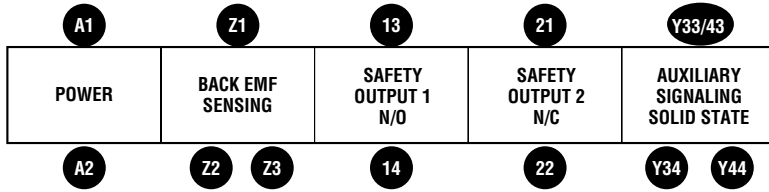

Block Diagram

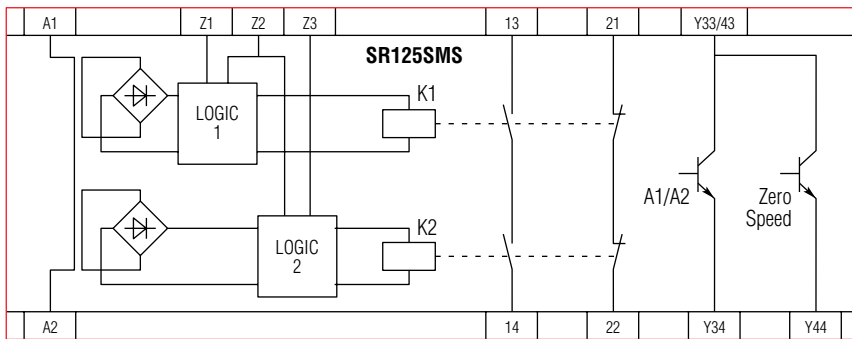

H safety monitoring relays

Dimensions — mm/in.

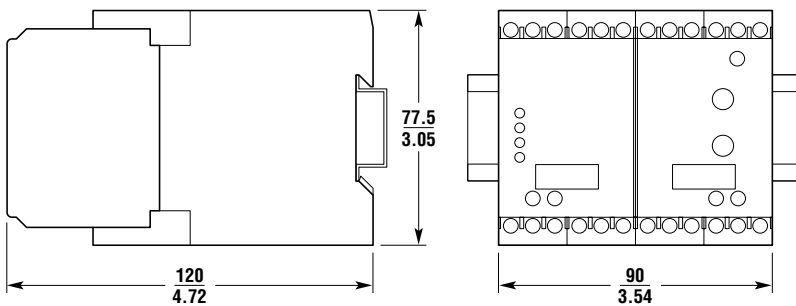

A Go to the Engineering Guide
For in-depth information on safety standards and use.

■ Specifications

Electrical	All Models	SR125SMS00	SR125SMS02	SRS125SMS03
Power Supply:	±10%	24 VDC	110 VAC	220 VAC
Power Consumption:		≤3.5 W	≤7 VA	≤7.5 VA
Internal Fuse:	Electronic			
Safety Inputs:	Back EMF sensing between Z1 and Z2 and Z3			
Maximum Motor Voltage:	500 VAC (0 to 60 Hz)			
Detection Threshold:	0.01 V			
Relay Outputs:	1 N/O + 1 N/C switched at preset detection threshold			
Auxiliary Outputs:	2 solid state for signaling			
Max Switched AC:	Inductive AC-15, 1800 VA inrush, 180 VA maintained			
Max Switched DC:	Inductive DC-13, 1.2-1.5 A/24 V			
Min Switched Current/Voltage:	10 mA/17 V (provided that the contact has never been used with higher loads)			
Impulse Withstand Voltage:	4000 V			
Max Drop-Out Time:	n/a			
Max Output Fuse:	4 A slow-acting or 6 A fast-acting			
Reset Mode:	n/a			
Mechanical				
Mounting:	35 mm (1.38 in.) DIN rail			
Case Material:	Polyamide PA6.6			
Max Wire Size:	2 x 2.5 mm (14 AWG) stranded			
Weight:	AC: 600 g (21 oz.); DC: 500 g (18 oz.)			
Color:	Red with black body			
External Adjustment:	Motor speed preset via potentiometer			
Indication:	Green = Power On	Green = Channel 1 activated,		
	Green = Channel 2 activated	Green = CH1 + CH2 activated		
Environmental				
Enclosure Protection:	IP20 terminals, IP40 (NEMA 1) housing			
Operating Temperature:	-10 to 55°C (14 to 131°F)			
Compliance				
Standards:	EN1088, EN954-1, EN292, EN692, EN60204-1,			
Approvals/Listings:	CE-marked for all applicable directives, UL and C-UL, CSA, BG			
Safety Category:	Cat. 3 per EN954-1 (SR125SMS internal operation)			

Specifications are subject to change without notice.

Note: The safety contacts of the Omron STI switches are described as normally closed (N/C)—i.e., with the guard closed, actuator in place, and the machine able to be started.

■ Ordering

Model	Supply	Inputs	Outputs	Auxiliary	Part No.
SR125SMS00	24 VDC	Back EMF Sensing	1 N/O + 1 N/C	2 Solid State	44510-1250
SR125SMS02	110 VAC	Back EMF Sensing	1 N/O + 1 N/C	2 Solid State	44510-1252
SR125SMS03	230 VAC*	Back EMF Sensing	1 N/O + 1 N/C	2 Solid State	44510-1253

*230 VAC units are available on special order. Minimum quantities may apply.