

LeCroy PP010 Passive Probe

Instruction Manual

Revision A – February 2006

Warranty

LeCroy warrants this oscilloscope accessory for normal use and operation within specification for a period of one year from the date of shipment. Spare parts, replacement parts and repairs are warranted for 90 days.

In exercising its warranty, LeCroy, at its option, will either repair or replace any assembly returned within the warranty period to the Customer Service Department of an authorized service center. However, this will be done only if the product is determined by LeCroy's examination to be defective because of workmanship or materials, and the defect is not caused by misuse, neglect, accident, abnormal conditions of operation; or, damaged by attempted repair or modifications by a non-authorized service facility.

The customer will be responsible for the transportation and insurance charges for the return of products to the service facility. LeCroy will return all products under warranty with transportation charges prepaid.

This warranty replaces all other warranties, expressed or implied, including, but not limited to, any implied warranty of merchantability, fitness, or adequacy for any particular purposes or use. LeCroy shall not be liable for any special, incidental, or consequential damages, whether in contract or otherwise.

Corporate Headquarters

700 Chestnut Ridge Road
Chestnut Ridge, NY 10977-6499
Tel: (845) 425-2000 Fax: (845) 425-8967
Internet: www.lecroy.com

© 2006 by LeCroy Corp. All rights reserved.

LeCroy, ActiveDSO, JitterTrack, WaveLink, WavePro, WaveMaster, WaveSurfer, and Waverunner are registered trademarks of LeCroy Corporation. Other product or brand names are trademarks or requested trademarks of their respective holders. Information in this publication supersedes all earlier versions. Specifications subject to change without notice.

Manufactured under an
ISO 9000 Registered
Quality Management
System

Visit www.lecroy.com to
view the certificate.

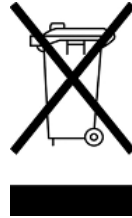

This electronic product is
subject to disposal and
recycling regulations that
vary by country and region.
Many countries prohibit the
disposal of waste electronic
equipment in standard waste
receptacles.

For more information about
proper disposal and
recycling of your LeCroy
product, please visit
www.lecroy.com/recycle.

PP010-OM-E Rev A
913945-00 Rev A

Introduction

The PP010 is a passive probe to be used with a LeCroy WaveJet oscilloscope having an input impedance of 1 M Ω . It has an attenuation ratio of 10:1.

Safety Information

This symbol appears on the product: 

It refers you to additional information contained in this manual. The corresponding information in the manual is similarly denoted.

To avoid personal injury and to prevent fire or damage to the probe or any products connected to it, review and comply with the following safety precautions.



WARNING -- ELECTRIC SHOCK HAZARD

Do not remove the probe case. Removal of the probe case may expose you to electric shock.

Do not disassemble the probe. Disassembling the probe may expose you to electric shock.

Do not disconnect the probe from the scope during measurement. Disconnecting the probe during measurement may expose you to electric.

Connect the probes grounding terminal to the ground potential of the device under test. Failure to connect to ground potential may expose you to electric shock.

Connect to properly grounded instruments. This probe is to be used only with test instruments having input connectors with the BNC shield (ring) connected to earth ground.

Connect the probe properly: Connect the probe to the measurement instrument before connecting the probe to test circuit. Do not disconnect the probe from the test instrument while the input is connected to the test circuit.

Do not connect the probe ground terminal to any point in the test circuit that is at a potential other than earth ground.



Do not apply to the input any potential that exceeds the maximum ratings of the probe. Refer to specifications.

Do not use in wet or explosive atmospheres.

For indoor use only. This probe is intended for indoor use and should be operated in a clean, dry environment.

Do not use the probe if any part is damaged. All maintenance should be referred to qualified service personnel.

 **Avoid physical injury.** The probe tip is extremely sharp. Use care when handling to prevent injury, including accidental skin puncture. Use of the probe and/or the test instrument it is connected to in a manner not specified by the manufacturer may impair the protection mechanisms.

Components

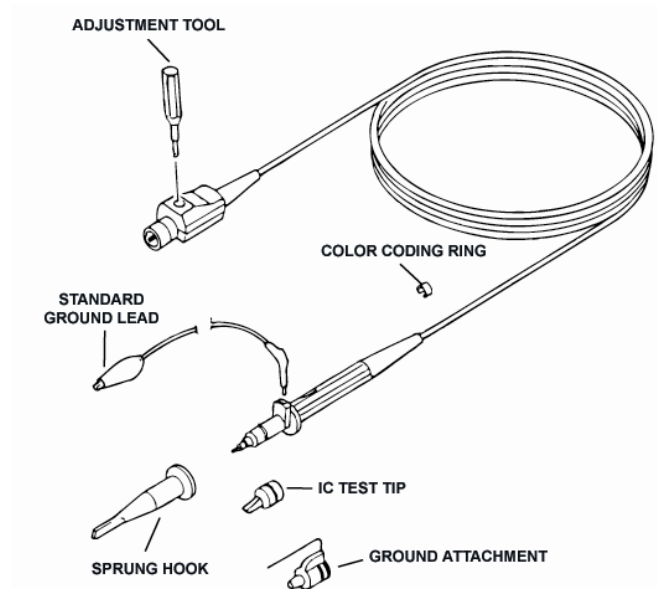

Accessories

Standard Accessory Replacement Kit PKIT2-5MM-101 contains the following items:

Part	Quantity
Standard Ground Lead	1
Sprung Hook	1
Color Coding Rings (set)	1
Adjustment Tool	1
Ground Attachment	1
IC Test Tip	1

Specifications

Electrical Characteristics

Bandwidth	DC to 200 MHz (± 3 dB)
Attenuation	10:1 $\pm 3\%$
Input RC	10 M Ω $\pm 2\%$ // 12.5 pF ± 2 pF
Compensation Range	18-35 pF
Probe Length	1.5 m
Connector Type	BNC

Environmental Conditions

Temperature (operating)	5 to 40 °C
(non-operating)	-20 to +70 °C
Humidity (operating)	80% RH (5 to 31 °C)
Altitude (operating)	up to 2000 m (6562 ft)

Electrical Ratings



Maximum Input Voltage 600 V (DC + AC_{peak})

Note: The maximum input voltage derates when frequency response is 1 MHz or higher. See voltage derating curve on the next page.

EC Declaration of Conformity

The PP010 probe meets intent of the European Council Directive 73/23/EEC for product safety per the following standard:

EN 61010-031:2002	Safety requirements for hand-held probe assemblies for electrical test and measurement Installation (Overvoltage) Category I (All mains isolated terminals) Pollution Degree 2
-------------------	---

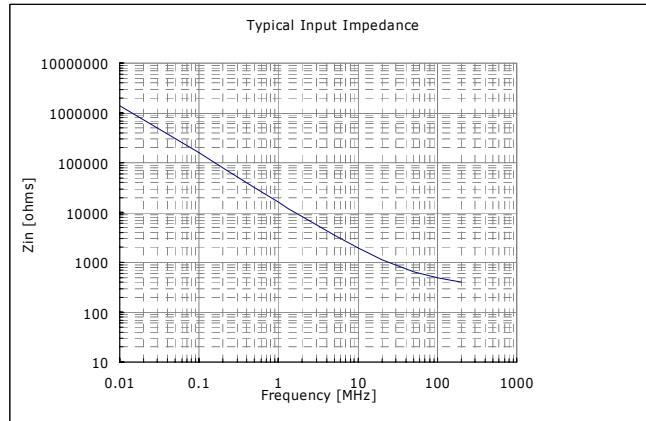
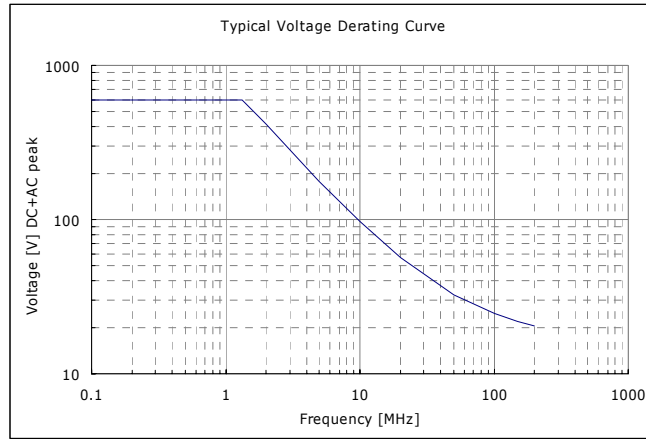

Probe Compensation

Proper compensation of the probe is required to assure good amplitude accuracy in the dynamic portions of the waveform being measured. LF compensation matches the probe to differences in oscilloscope input capacitance. The LF compensation should always be checked and adjusted as needed when first connecting a passive probe to the oscilloscope input.

LF compensation is performed by connecting the input of the probe to a low frequency square wave, such as the oscilloscope calibrator signal set to 1 kHz. The compensation is adjusted by rotating the trimmer pot accessible through the small hole in the center of the housing near the BNC connector. Use the tool supplied with the probe for this adjustment.

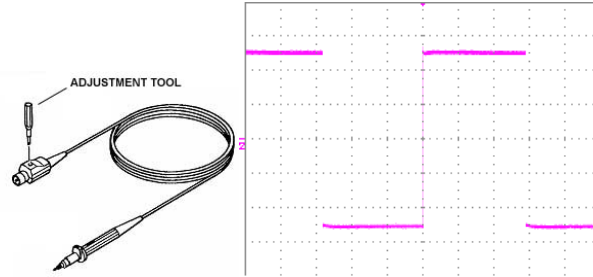

Adjusting Probe Compensation

§ § §