

Evaluating the LTC2672 Five-Channel, Low Dropout, 300 mA, Current Source Output, SoftSpan DAC

FEATURES

- ▶ Fully featured evaluation board for the [LTC2672](#)
- ▶ QuikEval evaluation software compatible
- ▶ Sample Arduino code compatible (available on the [Linduino](#) web page)

EVALUATION KIT CONTENTS

- ▶ [DC2903A](#) evaluation board
- ▶ Ribbon cable to connect to the Linduino [DC2026C](#)

EQUIPMENT NEEDED

- ▶ DC2026C controller board (must be purchased separately)
- ▶ PC running Windows® 7 or Windows 10
- ▶ Current meter

SOFTWARE NEEDED

- ▶ QuikEval evaluation software (available for download from the [DC2903A](#) product page)

DOCUMENTS NEEDED

- ▶ LTC2672 data sheet
- ▶ DC2903A design files (see the [DC2903A](#) product page)

EVALUATION BOARD PHOTOGRAPH

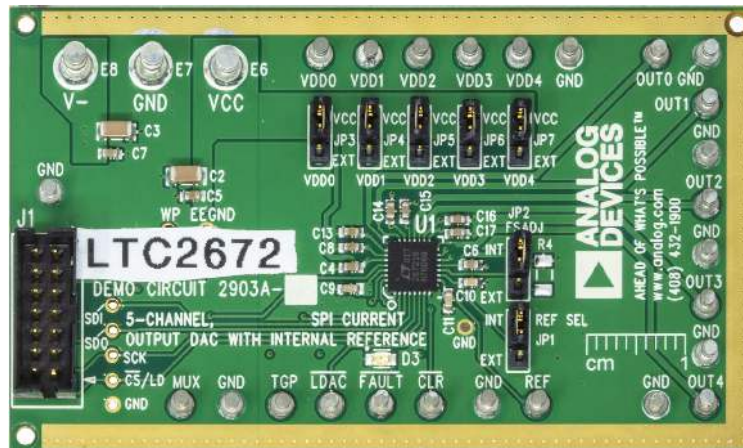

Figure 1. DC2903A Evaluation Board

GENERAL DESCRIPTION

The DC2903A is a fully featured evaluation board that evaluates the LTC2672, a five-channel, current source output digital-to-analog converter (DAC).

The DC2903A is controlled through a serial peripheral interface (SPI) from the J1 connector. The SPI signals are sent from the DC2026C controller board through the ribbon cable that is connected to the DC2903A.

The DC2903A uses QuikEval evaluation software to provide an intuitive graphical user interface (GUI) that configures and controls the LTC2672 using the SPI interface.

The LTC2672 is used for various current mode biasing applications such as tunable lasers or resistive heaters. The output current ranges are software selectable, and each channel is routed to the DC2903A MUX pin for external monitoring.

For full specifications on the LTC2672, see the LTC2672 data sheet, which must be consulted in conjunction with this user guide when using the DC2903A.

TABLE OF CONTENTS

Features.....	1	On-Board Connectors.....	4
Evaluation Kit Contents.....	1	Getting Started.....	5
Equipment Needed.....	1	Software Installation Procedures.....	5
Software Needed.....	1	Evaluation Hardware Setup.....	5
Documents Needed.....	1	Software Operation.....	5
General Description.....	1	Main Window.....	6
Evaluation Board Photograph.....	1	Using the Software.....	7
Evaluation Board Hardware.....	3	Normal View.....	7
Evaluation Board Overview.....	3	Toggle View.....	9
Power Supplies.....	3	Controls for the LTC2672 Toggle Function.....	10
Analog Outputs.....	4	Troubleshooting.....	11
Digital Interface.....	4	Hardware.....	11
Reference.....	4	Evaluation Board Schematic.....	12
Multiplexer Output.....	4	Ordering Information.....	13
Precision R _{SET} Resistor.....	4	Bill of Materials.....	13

REVISION HISTORY**4/2021—Rev. 0 to Rev. A**

Change to DC2903A User Guide Title.....	1
Changes to General Description Section.....	1
Changes to Figure 1.....	1

2/2021—Revision 0: Initial Version

EVALUATION BOARD HARDWARE

EVALUATION BOARD OVERVIEW

The DC2903A requires the power connections and connection to the DC2026C controller board shown in Figure 2. The ribbon cable provided in the evaluation kit connects the DC2903A and the DC2026C via the J1 connector. Turrets are provided to connect the DC2903A to the power supplies.

The DC2903A has other optional features to allow the user to select an external reference, change the full-scale current, and monitor various outputs through the on-board monitor MUX pin. These optional features do not need to be changed for normal operation.

POWER SUPPLIES

The DC2903A is powered using external supplies. The minimum requirement to power the DC2903A is to provide 2.1 V to 5.5 V on E6 (VCC) and connect E7 (GND) and E8 (V-) to ground (GND).

The supply connection to E8 (V-) can be from -5.5 V to ground (GND) to accommodate applications that require a negative supply.

E23 and E25 to E28 (VDD0 to VDD4, respectively) can be connected to a separate external supply to power the output stages of the individual device channels. To use an external supply on a channel, set the corresponding jumper, JP3 to JP7 (VDD0 to VDD4, respectively), to the EXT position and apply power to the appropriate turret (E23, E25, E26, E27, or E28).

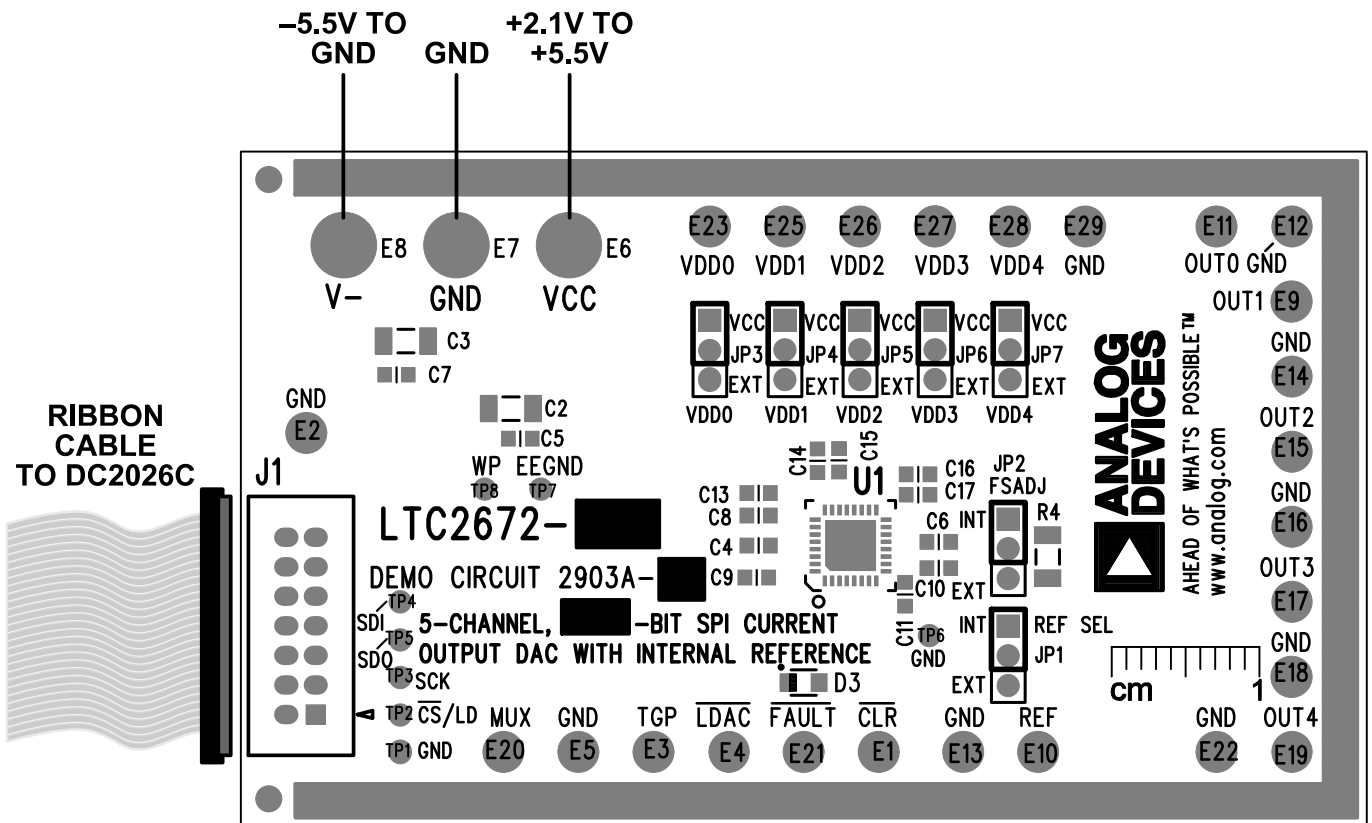

Figure 2. DC2903A Hardware Connections

003

EVALUATION BOARD HARDWARE

ANALOG OUTPUTS

The analog outputs, OUT0 to OUT4, are available on the E11, E9, E15, E17, and E19 turrets, respectively. Return paths for the ground currents are available on the E12, E14, E16, E18, and E22 (GND) turrets. Because the corresponding [LTC2672](#) analog outputs are currents, the load that is connected to the OUT0 to OUT4 outputs must have a return connection to ground (GND) via the appropriate GND turret.

DIGITAL INTERFACE

DC2026C Connections

The [DC2903A](#) uses the [DC2026C](#) to integrate with the QuikEval evaluation software through the SPI. Use the provided ribbon cable to connect J1 of the DC2903A to J1 of the DC2026C. When this connection is made, the DC2026C powers the electrically erasable programmable read-only memory (EEPROM) on the DC2903A. The QuikEval evaluation software uses the EEPROM to identify the DC2903 and load the proper module.

To ensure proper serial transfers and compatibility, the DC2026C powers the IO_{VCC} pin of the LTC2672, which is nominally 5 V.

DC2026C Connector Pin Descriptions

[Figure 3](#) shows the pins for the DC2026C J1 connector. For descriptions of each pin, see [Table 1](#).

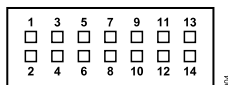

Figure 3. DC2026C J1 Connector Pins

Table 1. DC2026C Connector J1 Pin Descriptions

Pin No.	Mnemonic	Description
1	V+	Unregulated voltage from the DC2026C, nominally 7 V
2	VCCIO	I/O voltage set by JP3 on the DC2026C
3	GND	Ground
4	SCL/SCK	Serial clock from the DC2026C
5	MISO	Serial data from the DC2903A
6	CS	Chip select from the DC2026C
7	SDA/MOSI	Serial data from the DC2026C
8	GND	Ground
9	EEDA	Serial data for EEPROM
10	EEV _{CC}	V _{CC} for EEPROM
11	EESCL	Serial clock for EEPROM
12	EEGND	Ground for EEPROM
13	GND	Ground
14	NC	No connection

REFERENCE

By default, the DC2903A uses the internal reference of the LTC2672. To use an external reference, place the DC2903A JP1 jumper into the EXT position and apply an external reference to E10 (REF).

MULTIPLEXER OUTPUT

The LTC2672 has a diagnostic feature that outputs compliance voltages, output currents, and internal die temperature monitoring. The output compliance voltages and representative voltages of the output current and internal die temperature are multiplexed on-chip and are available on the DC2903A E20 connector (MUX). Refer to the LTC2672 data sheet for more details on the multiplexer functionality.

PRECISION R_{SET} RESISTOR

The LTC2672 integrates an on-chip, 20 kΩ resistor that defines the reference current generation. Additionally, the DC2903A contains an optional on-board location for a ±0.2 ppm/°C precision resistor. Refer to the LTC2672 data sheet for more details on the optional external precision resistor.

ON-BOARD CONNECTORS

[Table 2](#) describes the 33 on-board connectors on the DC2903A.

Table 2. On-Board Connectors

Connector	Function
J1	SPI/I ² C interface pin header connector
JP1	REF select
JP2	FSADJ select
JP3 to JP7	Internal or external VDDx voltage select
E1	CLR
E2, E5, E12 to E14, E16, E18, E22, E29	GND connections
E3	Toggle enable (TGP)
E4	LDAC
E6	VCC positive voltage supply
E7	GND for power supply
E8	V- negative voltage supply
E9	Channel 1 output pin (OUT1)
E10	External reference connection (REF)
E11	Channel 0 output pin (OUT0)
E15	Channel 2 output pin (OUT2)
E17	Channel 3 output pin (OUT3)
E19	Channel 4 output pin (OUT4)
E20	Multiplexer output (MUX)
E23, E25 to E28	External supplies for VDDx pins

GETTING STARTED

The QuikEval evaluation software controls and configures the on-board [LTC2672](#) through the [DC2026C](#).

SOFTWARE INSTALLATION PROCEDURES

Before connecting the DC2026C to the [DC2903A](#), take the following steps to set up the DC2903A for initial use in the QuikEval evaluation software:

1. Download the QuikEval evaluation software package from the DC2903A product page to start the QuikEval evaluation software installation.
2. Open the **ltcqev.exe** file and follow the instructions in the folder to complete the software installation process.

EVALUATION HARDWARE SETUP

When the QuikEval evaluation software installation is complete, take the following steps to set up the DC2026C and the DC2903A together:

1. Connect the DC2026C to the DC2903A via the J1 connectors with the ribbon cable provided (see [Figure 2](#)).
2. Connect the desired power supplies to E6 (VCC), E7 (GND), and E8 (V-) on the DC2903A.
3. Connect the desired load to the appropriate channel on the DC2903A E11 pin (OUT0), E9 pin (OUT1), E15 pin (OUT2), E17 pin (OUT3), or E19 pin (OUT4).

4. Connect the load to a GND pin on the DC2903A (E12, E14, E16, E18, or E22) to complete the ground return path.
5. Start the QuikEval evaluation software (see the [Software Operation](#) section).

SOFTWARE OPERATION

To start the QuikEval evaluation software, from the **Start** menu, click **Analog Devices > QuikEval**. The software window opens (see [Figure 4](#)) until the software recognizes the DC2903A. When the software recognizes the DC2903A, the main software window in [Figure 5](#) opens.

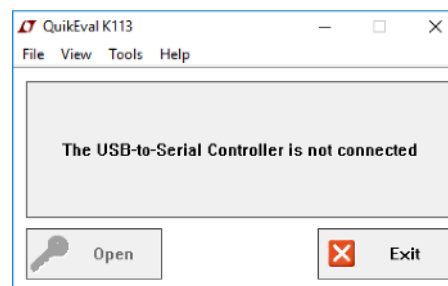

Figure 4. Select Interface Window

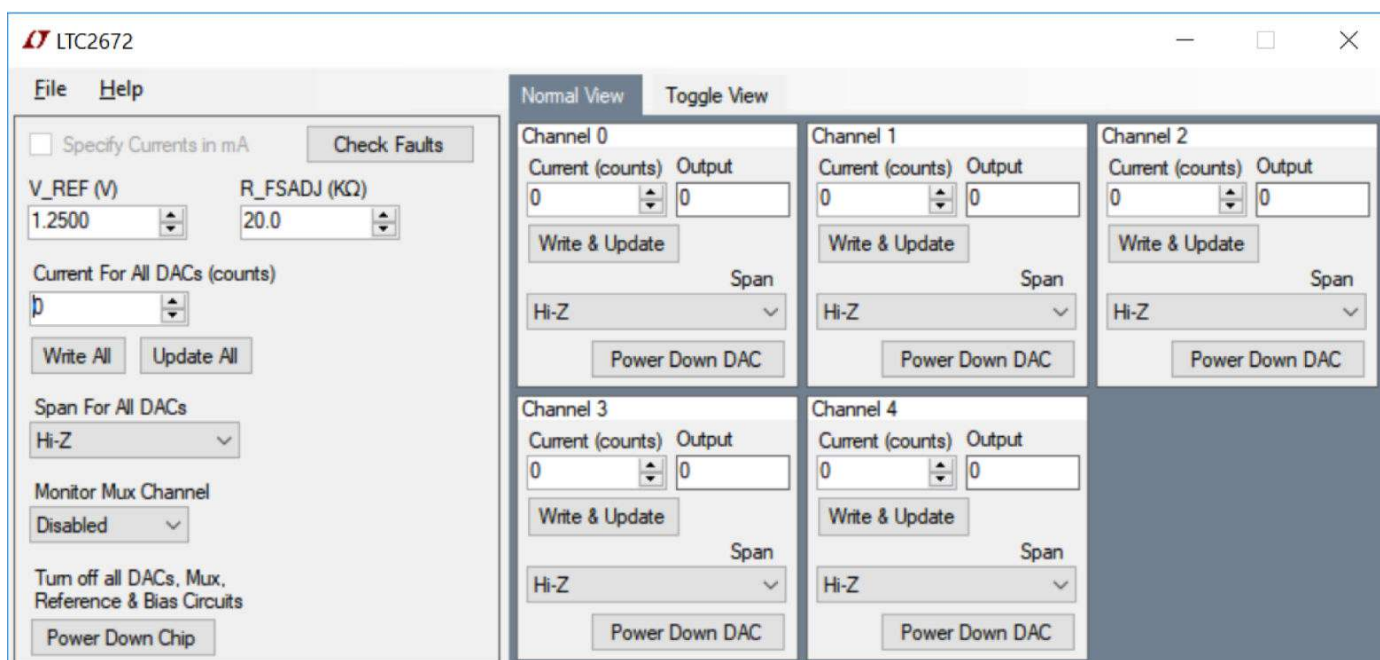

Figure 5. QuikEval Evaluation Software Main Window

GETTING STARTED

MAIN WINDOW

In the main QuikEval evaluation software window (see [Figure 5](#)), each channel can be written to individually or all channels can be written to at once as a group. Various settings for the [LTC2672](#) are available in this window, including the range, reference voltage, toggle options, and full-scale adjustment resistor (**R_FSADJ**) settings. The fault register is read and displayed after every data transfer.

Refer to the LTC2672 data sheet for more information on the device features associated with the different tab functions that are described in the following sections.

See the [Using the Software](#) section for more details on the controls displayed in the main QuikEval evaluation software window.

Reference Configuration

The [DC2903A](#) uses the LTC2672 internal 20 k Ω resistor to set the full-scale range. If a different resistor is manually populated on R4 of the DC2903A, the resistor value can be changed in the **R_FSADJ (K Ω)** text box (see [Figure 5](#)).

Similarly, if a different external reference voltage is used, the resistor value can be changed in the **V_REF (V)** text box (see [Figure 5](#)).

Setting the Channel Output Range

To set the output range for all LTC2672 channels at once, use the **Span For All DACs** dropdown menu. To set the output range for individual LTC2672 channels, use the **Span** dropdown menu for each individual channel (see [Figure 5](#)).

Setting the Channel Current Value

To set the output current for all LTC2672 channels at once, use the **Current For All DACs (counts)** text box. To set the output current for individual LTC2672 channels, use the **Current (counts)** text box for each individual channel (see [Figure 5](#)).

If all channels are in the same range, the user can select the **Specify Currents in mA** checkbox to specify the currents in mA instead of counts.

When the desired span and code are entered, click **Write All** and then click **Update All** for the configured current values to appear at the output of all DACs. To update individual channels, click **Write & Update** in the individual channel block of the GUI.

For example, in [Figure 6](#), a current of 100 mA is assigned on each channel. When the device is configured, connect a current meter to the desired output channel from the corresponding output turret through the current meter to GND, and click **Write All** and the click **Update All**. The current meter displays 100 mA.

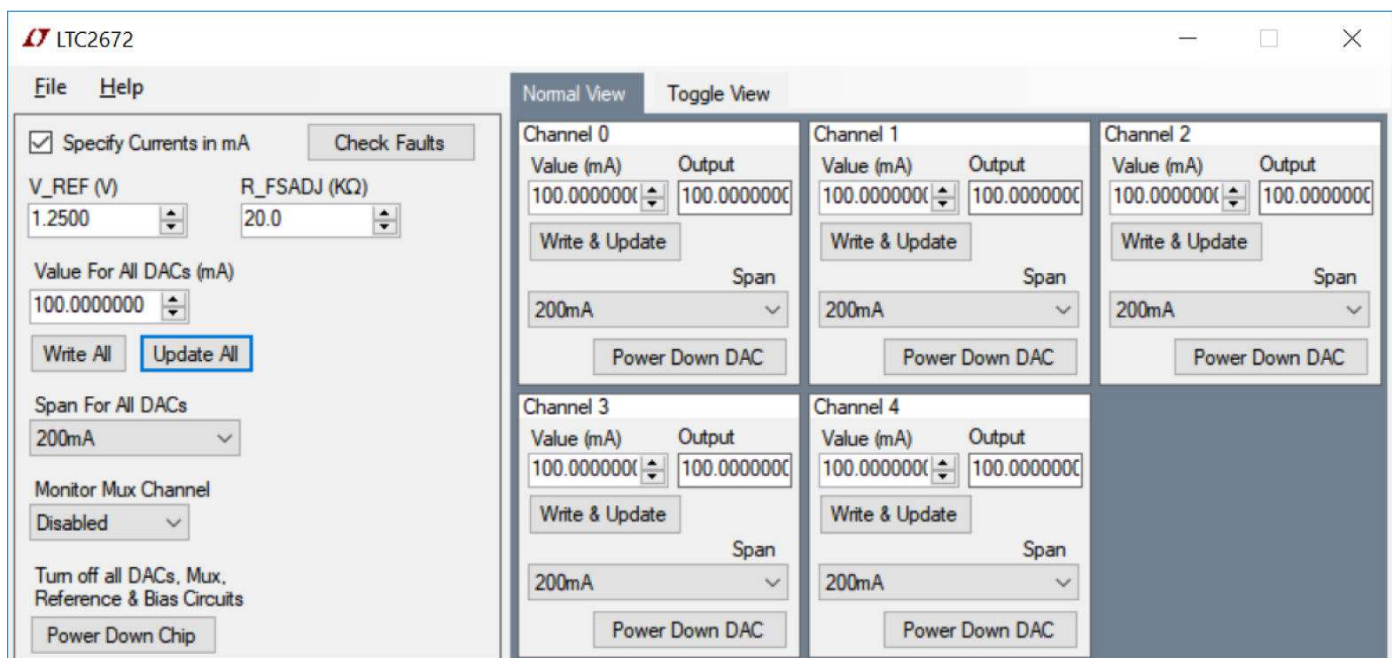

Figure 6. Example Configuration

USING THE SOFTWARE

NORMAL VIEW

When the QuikEval evaluation software initially opens, normal view is shown by default with the **Normal View** tab selected (see [Figure 7](#)). Normal view allows the user to change most settings on the **LTC2672** and the settings of each channel with the exception of settings related to the device toggle ability.

Global Controls for Normal View

Note that all controls available in the **Normal View** tab are also available in the **Toggle View** tab. See the [Toggle View](#) section for controls specific to the **Toggle View** tab.

Specify Currents in mA

When the **Specify Currents in mA** checkbox is selected, the individual **Current (counts)** text boxes for each channel take values in mA. Otherwise, the input units are in counts. The QuikEval evaluation software converts the mA values to counts using the option selected from the **Span For All DACs** dropdown menu.

Note that values cannot be specified in mA if one or more channels have an individual span setting that does not match the span for all DAC setting because the current is ambiguous in terms of counts in this case.

Currents for All DACs (Counts)

The **Current For All DACs (counts)** text box allows the user to set a current value that is sent to all DAC channels.

Note that in general, this entered value does not reflect the existing current value of the DACs.

Write All

Click **Write All** to send a write to all DAC input register commands to the **LTC2672** with the value in the **Current For All DACs (counts)** text box.

Update All

Click **Update All** to send an update to all DAC register commands to the **LTC2672**. These commands send the value from either Register A or Register B to the DAC output register for each channel, depending on the state of the A/B register bit for that channel and the state of the toggle bit.

Span for All DACs

Select an option from the **Span For All DACs** dropdown menu to send a write span of all DAC commands to the **LTC2672**.

These commands change the span (minimum and maximum output voltages) for every channel.

If one or more channels has a different span, the **Specify Currents in mA** option is enabled when a command is set, but the **Specify**

Currents in mA checkbox is not selected. To enter values in mA, select the **Specify Currents in mA** checkbox.

Monitor Mux Channel

Select an item from the **Monitor Mux Channel** dropdown menu to send a monitor multiplexer operation command to the **LTC2672**.

On the **DC2903A**, the monitor multiplexer output is available at the MUX turret.

To monitor an individual channel, probe the MUX port and select the desired channel from the **Monitor Mux Channel** dropdown menu. The monitored channel box is highlighted in yellow, and the Channel x box title changes to indicate that the channel is monitored.

Power-Down Chip

Click **Power Down Chip** to send a power-down chip command to the **LTC2672** and power down all channels. All Channel x box titles darken, and the titles change to indicate that the channels are powered down.

The reference and the monitor multiplexer also power down.

Update any or all channels to wake up the updated channel as well as the reference and monitor multiplexer.

Update a powered down channel to wake the channel up again.

Controls for Individual LTC2672 Channels in the Normal View Tab

The following sections detail the labels that appear in each Channel x box in the **Normal View** tab of the main QuikEval evaluation software window.

Currents (Counts)

Use the scroll arrows or enter a value in the **Current (counts)** text box to set the current value that is sent to the **LTC2672** during a write command that affects the corresponding channel. The units are in either mA or counts.

Output

The **Output** box is a read-only display that indicates the current output in either mA or counts. This value matches the actual measured value at the output of the DAC.

Write and Update

Click **Write & Update** to send a write to and to update the (power-up) DAC register n command to the **LTC2672** with the value in the **Current (counts)** text box.

This command causes the corresponding channel output to be the current specified in the **Current (counts)** box and wakes up the channel if the DAC channel is powered down.

USING THE SOFTWARE

Span

Select an option from the **Span** dropdown menu to send a write span of the DAC n command to the LTC2672.

This command changes the span (minimum and maximum output current) for the corresponding channel.

If one or more channels is changed to a span that is different from the other DAC spans, the **Specify Current in mA** option is disabled, and all current numeric entries switch to counts (if not already measured in counts).

Power-Down DAC

Click **Power Down DAC** to power down the channel. The Channel x box title darkens, and the title changes to indicate that the channel is powered down.

Update commands wake the channel up again.

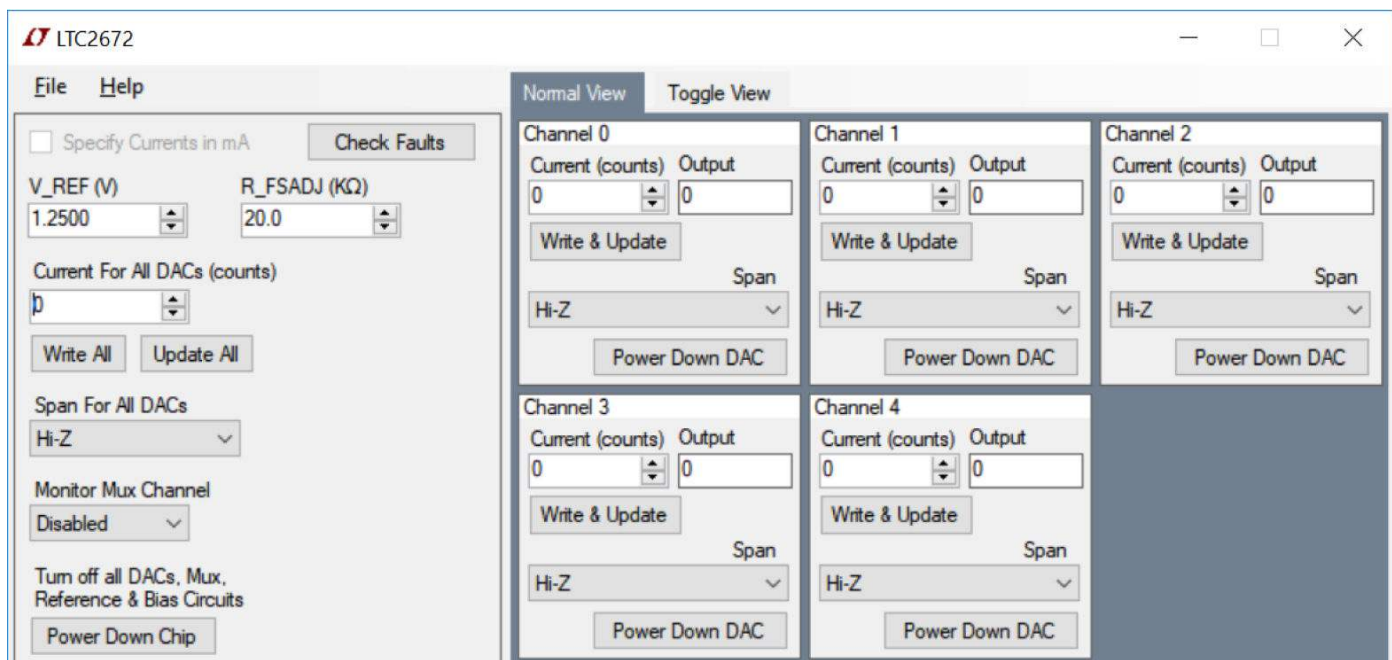

Figure 7. QuikEval Evaluation Software Normal View Tab

USING THE SOFTWARE

TOGGLE VIEW

The QuikEval evaluation software allows the user to switch the [LTC2672](#) outputs by selecting the **Toggle View** tab (see [Figure 8](#)). Toggle view allows the user to switch the output channels between Register A and Register B on each LTC2672 channel.

Global Controls for Toggle View

Write All

Click **Write All** to send a write to all the DAC input register commands to the LTC2672 with a value in the **Current For All DACs (counts)** text box.

These commands send a value to either Register A or Register B for each channel, depending on whether the A/B register bit is set for that channel.

If the A/B register bit for a channel is set, the value is sent to Register B. Otherwise, the value is sent to Register A.

Update All

Click **Update All** to send an update to all the DAC register commands to the LTC2672.

These commands send the value from either Register A or Register B to the DAC output register for each channel, depending on the state of the A/B register bit and the state of the toggle bit for that channel.

If the A/B register bit and the toggle bit for a channel are set, the value is taken from Register B.

If the A/B register bit or the toggle bit is not set, the value is taken from Register A.

A/B Select

Select or clear any of the **Bit 0** to **Bit 4** checkboxes to send a write to A/B register command to the LTC2672.

Channels with the A/B bit set write to Register B on a write command or write all command.

Channels with the A/B bit set update the DAC register from Register B if the toggle bit is set.

Channels with the A/B bit set update the DAC register whenever the toggle bit (or TGP pin) changes value.

Channels with the A/B bit set wake up when the toggle bit (or TGP pin) changes value when the channels power down.

Toggle Bit

Click the button under **Toggle Bit** to send toggle DAC channel commands to the LTC2672. The text on the button changes to

indicate the state of the toggle bit (**High** indicates true or set, and **Low** indicates false or cleared).

The value of the toggle bit is combined (AND'ed) with the TGP pin such that switching the bit is only successful if the TGP pin is tied high, and switching the TGP pin is only successful if the toggle bit is set high.

Switching the bit (or TGP pin) results in the following outcomes.

First, the source for the DAC output register changes. If the bit goes from low to high, the source changes to Register B. If the bit goes from high to low, the source changes to Register A.

Second, an update occurs that moves the contents of the new source register into the DAC output register.

If Register A is connected to the DAC and the button under **Toggle Bit** is clicked, the connection changes so that Register B is connected, and the output display populates with the contents of Register B.

Auto Toggle dt (ms)

The value in the **Auto Toggle dt (ms)** text box represents the rate in milliseconds that the output switches from Register A to Register B when the toggle bit is selected, and the auto toggle option is turned on.

Auto Toggle

Click **Auto Toggle** to cause the button under **Toggle Bit** to automatically switch at a rate determined by the value in the **Auto Toggle dt (ms)** text box.

Click **Auto Toggle** again to turn the auto toggle option off.

Controls for Individual LTC2672 Channels in the Toggle View Tab

The following labels appear in each Channel x box in the **Toggle View** tab of the main QuikEval evaluation software window.

Current (Counts)

See the [Currents \(Counts\)](#) section of the [Controls for Individual LTC2672 Channels in the Normal View Tab](#) section. The functionality of the **Current (counts)** text box in the **Toggle View** tab is the same as that of the **Current (counts)** text box in the **Normal View** tab.

Write

See the [Write and Update](#) section of the [Controls for Individual LTC2672 Channels in the Normal View Tab](#) section. The functionality of the **Write** button in the **Toggle View** tab is the same as that of the **Write & Update** button in the **Normal View** tab.

USING THE SOFTWARE

A

The **A** text box contains a read-only display that indicates the current Register A value in either mA or counts.

B

The **B** text box contains a read-only display that indicates the current Register B value in either mA or counts.

DAC Register

The DAC register text box contains a read-only display that indicates the current output in mA or counts.

The value in this text box matches the actual measured value at the output of the DAC.

CONTROLS FOR THE LTC2672 TOGGLE FUNCTION

The **LTC2672** has a double buffered output register system that supports toggling between the two input values stored in Register A and Register B. Clicking the **Toggle View** tab keeps most of the **Normal View** tab functionality with the added ability to access the input buffer registers. To fill both Register A and Register B, take the following steps in the **Toggle View** tab:

1. In toggle mode, enter the desired value for Register A in the **Current (counts)** text box of the desired Channel x box.
2. Click **Write** to send the data to Register A.
3. Select one of the Bit x checkboxes under **A/B Select** section to indicate the desired channel. Note that the **Current (counts)** value in the Channel x box is now connected to Register B.
4. Enter a new value in the **Current (counts)** box for Register B.
5. Click **Write** to send the data to Register B.
6. Click **Auto Toggle** to change which register feeds the DAC output register and to update the DAC output register. Note that Register B connects to the DAC register and the DAC register receives the value of Register B.
7. Click **Auto Toggle** again to change which register feeds the DAC output register and to update the DAC output register. Note that Register A connects to the DAC register, and the DAC register receives the value of Register A.
8. Successive toggles continue to switch the DAC output. Note that leaving the toggle bit high and pulling the TGP pin up and down also switches the DAC output.

Note that switching in the QuikEval evaluation software is only successful when the TGP pin is tied high.

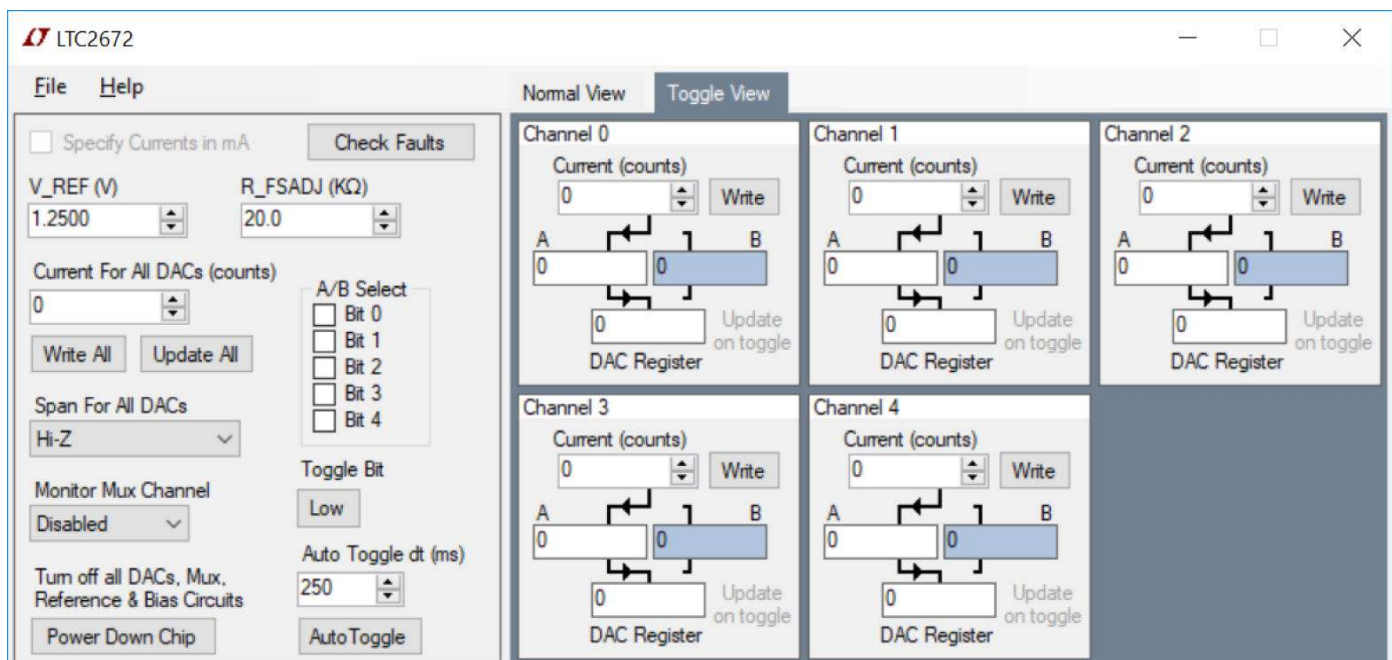

Figure 8. QuikEval Evaluation Software Toggle View Tab

TROUBLESHOOTING**HARDWARE**

A comprehensive list of frequently asked questions (FAQ) is available on the [LTC2672: FAQ](#) page in the [EngineerZone](#) site. For additional questions, submit these questions to the precision DACs section of the EngineerZone® site.

EVALUATION BOARD SCHEMATIC

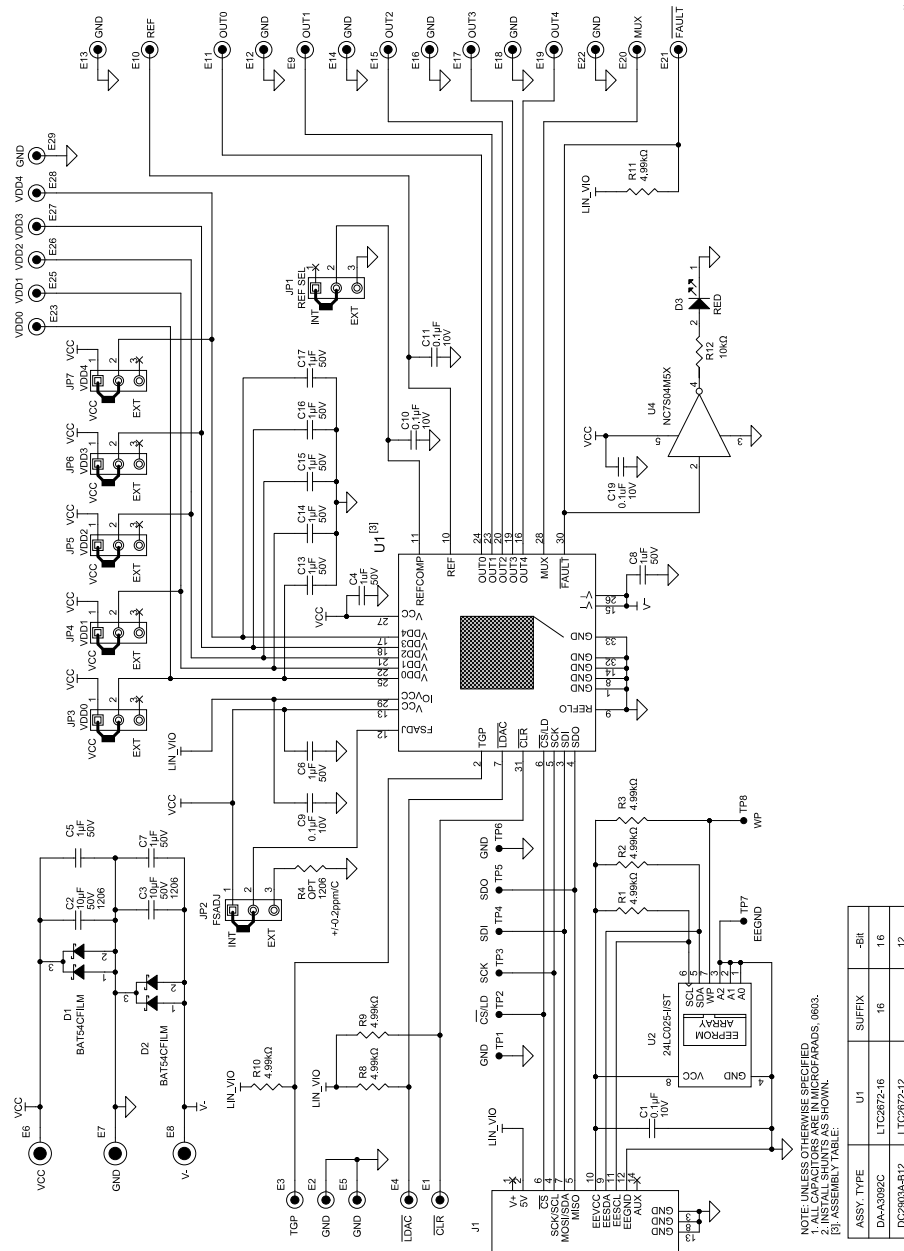

Figure 9. DC2903A Schematic

ORDERING INFORMATION

BILL OF MATERIALS

Table 3. Bill of Materials

Qty	Reference Designator	Description	Manufacturer	Part Number
7	R1 to R3, R8 to R11	Resistors, 4.99 kΩ, 1%, 1/10 W, 0603, AEC-Q200	Panasonic	ERJ3EKF4991V
1	R12	Resistor, 10 kΩ, 1%, 1/10 W, 0603, AEC-Q200	NIC	NRC06F1002TRF
10	C4 to C8, C13 to C17	Capacitors, 1 μF, X5R, 50 V, 10%, 0603	Samsung	CL10A105KB8NNNC
2	C2, C3	Capacitors, 10 μF, X5R, 50 V, 10%, 1206	TDK	C3216X5R1H106K160AB
5	C1, C9 to C11, C19	Capacitors, 0.1 μF, X5R, 10 V, 10%, 0603	ATX	0603ZD104KAT2A
2	D1, D2	Diodes, Schottky, 40 V, 300 mA, SOT-23	ST Microelectronics	BAT54CFILM
1	J1	Connector, shrouded header, male, 2 × 7, 2 mm, vertical, straight, through-hole	Molex	87831-1420
7	JP1 to JP7	Connectors, header, male, 1 × 3, 2 mm, through-hole, straight	SAMTEC	TMM-103-02-L-S
3	E6 to E8	Test points, turret, 0.094 inch, printed circuit board (PCB), 0.062 inches thick	MILL-MAX	2501-2-00-80-00-00-07-0
25	E1 to E5, E9 to E23, E25 to E29	Test points, turret, 0.064 inch, PCB, 0.062 inches thick	MILL-MAX	2308-2-00-80-00-00-07-0
1	D3	Light emitting diode (LED), red, water clear, 0805	Würth	150080RS75000
1	U4	IC, tiny logic high speed inverter, SOT23-5	FAIRCHILD SEMI	NC7S04M5X
1	U2	IC, memory, EEPROM, 2 Kbits (256 × 8), 400 kHz	Microchip	24LC025-I/ST
1	U1	Five-channel, low dropout, 300 mA, current source output, 12-/16-bit SoftSpan™ DAC	Analog Devices, Inc.	LTC2672

I²C refers to a communications protocol originally developed by Philips Semiconductors (now NXP Semiconductors).

**ESD Caution**

ESD (electrostatic discharge) sensitive device. Charged devices and circuit boards can discharge without detection. Although this product features patented or proprietary protection circuitry, damage may occur on devices subjected to high energy ESD. Therefore, proper ESD precautions should be taken to avoid performance degradation or loss of functionality.

Legal Terms and Conditions

By using the evaluation board discussed herein (together with any tools, components documentation or support materials, the "Evaluation Board"), you are agreeing to be bound by the terms and conditions set forth below ("Agreement") unless you have purchased the Evaluation Board, in which case the Analog Devices Standard Terms and Conditions of Sale shall govern. Do not use the Evaluation Board until you have read and agreed to the Agreement. Your use of the Evaluation Board shall signify your acceptance of the Agreement. This Agreement is made by and between you ("Customer") and Analog Devices, Inc. ("ADI"), with its principal place of business at One Technology Way, Norwood, MA 02062, USA. Subject to the terms and conditions of the Agreement, ADI hereby grants to Customer a free, limited, personal, temporary, non-exclusive, non-sublicensable, non-transferable license to use the Evaluation Board FOR EVALUATION PURPOSES ONLY. Customer understands and agrees that the Evaluation Board is provided for the sole and exclusive purpose referenced above, and agrees not to use the Evaluation Board for any other purpose. Furthermore, the license granted is expressly made subject to the following additional limitations: Customer shall not (i) rent, lease, display, sell, transfer, assign, sublicense, or distribute the Evaluation Board; and (ii) permit any Third Party to access the Evaluation Board. As used herein, the term "Third Party" includes any entity other than ADI, Customer, their employees, affiliates and in-house consultants. The Evaluation Board is NOT sold to Customer; all rights not expressly granted herein, including ownership of the Evaluation Board, are reserved by ADI. CONFIDENTIALITY. This Agreement and the Evaluation Board shall all be considered the confidential and proprietary information of ADI. Customer may not disclose or transfer any portion of the Evaluation Board to any other party for any reason. Upon discontinuation of use of the Evaluation Board or termination of this Agreement, Customer agrees to promptly return the Evaluation Board to ADI. ADDITIONAL RESTRICTIONS. Customer may not disassemble, decompile or reverse engineer chips on the Evaluation Board. Customer shall inform ADI of any occurred damages or any modifications or alterations it makes to the Evaluation Board, including but not limited to soldering or any other activity that affects the material content of the Evaluation Board. Modifications to the Evaluation Board must comply with applicable law, including but not limited to the RoHS Directive. TERMINATION. ADI may terminate this Agreement at any time upon giving written notice to Customer. Customer agrees to return to ADI the Evaluation Board at that time. LIMITATION OF LIABILITY. THE EVALUATION BOARD PROVIDED HEREUNDER IS PROVIDED "AS IS" AND ADI MAKES NO WARRANTIES OR REPRESENTATIONS OF ANY KIND WITH RESPECT TO IT. ADI SPECIFICALLY DISCLAIMS ANY REPRESENTATIONS, ENDORSEMENTS, GUARANTEES, OR WARRANTIES, EXPRESS OR IMPLIED, RELATED TO THE EVALUATION BOARD INCLUDING, BUT NOT LIMITED TO, THE IMPLIED WARRANTY OF MERCHANTABILITY, TITLE, FITNESS FOR A PARTICULAR PURPOSE OR NON-INFRINGEMENT OF INTELLECTUAL PROPERTY RIGHTS. IN NO EVENT WILL ADI AND ITS LICENSORS BE LIABLE FOR ANY INCIDENTAL, SPECIAL, INDIRECT, OR CONSEQUENTIAL DAMAGES RESULTING FROM CUSTOMER'S POSSESSION OR USE OF THE EVALUATION BOARD, INCLUDING BUT NOT LIMITED TO LOST PROFITS, DELAY COSTS, LABOR COSTS OR LOSS OF GOODWILL. ADI'S TOTAL LIABILITY FROM ANY AND ALL CAUSES SHALL BE LIMITED TO THE AMOUNT OF ONE HUNDRED US DOLLARS (\$100.00). EXPORT. Customer agrees that it will not directly or indirectly export the Evaluation Board to another country, and that it will comply with all applicable United States federal laws and regulations relating to exports. GOVERNING LAW. This Agreement shall be governed by and construed in accordance with the substantive laws of the Commonwealth of Massachusetts (excluding conflict of law rules). Any legal action regarding this Agreement will be heard in the state or federal courts having jurisdiction in Suffolk County, Massachusetts, and Customer hereby submits to the personal jurisdiction and venue of such courts. The United Nations Convention on Contracts for the International Sale of Goods shall not apply to this Agreement and is expressly disclaimed.