

# **IDS-205F Hardware Installation Guide**

## **Managed Industrial Ethernet Switches**

THE SPECIFICATIONS AND INFORMATION REGARDING THE PRODUCTS IN THIS GUIDE ARE SUBJECT TO CHANGE WITHOUT NOTICE. ALL STATEMENTS, INFORMATION, AND RECOMMENDATIONS IN THIS GUIDE ARE BELIEVED TO BE ACCURATE BUT ARE PRESENTED WITHOUT WARRANTY OF ANY KIND, EXPRESS OR IMPLIED. USERS MUST TAKE FULL RESPONSIBILITY FOR THEIR APPLICATION OF ANY PRODUCTS.

This equipment has been tested and found to comply with the limits for a Class A digital device, pursuant to part 15 of the FCC rules. These limits are designed to provide reasonable protection against harmful interference when the equipment is operated in a commercial environment. This equipment generates, uses, and can radiate radio-frequency energy and, if not installed and used in accordance with this hardware guide may cause harmful interference to radio communications. Operation of this equipment in a residential area is likely to cause harmful interference, in which case users will be required to correct the interference at their own expense.

Modifications to this product not authorized by Perle could void the FCC approval and negate your authority to operate the product.

Perle reserves the right to make changes without further notice, to any products to improve reliability, function, or design.

Perle, the Perle logo, and IDS Switch are trademarks of Perle Systems Limited.

©2016. Perle Systems Limited.

# Table of Contents

Preface .....	2
Overview .....	3
Switch Model View .....	4
LED Indicators .....	5
Ports .....	6
Port Status Indicators .....	7
Installation .....	8
Cautions and Warnings .....	8
Terminal Block-Power Connectors .....	9
Connecting the Console Port .....	10
Connecting Destination Ports .....	11
Resetting the Switch .....	12
Booting the Switch .....	13
Fast Setup Mode .....	13
Password Recovery .....	13
Configuring the IDS Switch .....	14
Appendix A - Technical Specifications .....	15
Appendix B - Labels .....	17
Appendix C - Mechanical Drawings .....	18
Appendix D - IDS DIN Rail and Wall Mounting .....	19
Appendix E - IDS Maintenance .....	21
Appendix F - Cables and Connectors .....	22

---

# Preface

## Audience

This guide is for the network or computer technician responsible for installing Perle IDS-205 series switches. We assume that you are familiar with the concepts and terminology of Ethernet and local area networks.

## Purpose

This document describes the hardware and physical characteristics of the Perle IDS switch. It covers hardware features as well as installation and operation of the switch. This document does not cover how to configure your Perle IDS switch. Information to configure your Perle IDS switch can be found in the Perle IDS User's Guide

## Package Contents

- IDS switch with attached DIN rail mounting bracket
- Quick Start Guide

## Document Conventions

This document contains the following conventions:

Most text is presented in the typeface used in this paragraph. Other typefaces are used to help you identify certain types of information. The other typefaces are:

**Note:** *Means reader take note:* notes contain helpful suggestions.

**Caution:** Means reader be careful. In this situation, you might perform an action that could result in equipment damage or loss of data.

### **Warning: IMPORTANT SAFETY INSTRUCTIONS**

Means danger. You are in a situation that could cause bodily injury. Before you work on any equipment, be aware of the hazards involved with electrical circuitry and be familiar with standard practices for preventing accidents. Only qualified personnel should connect power to this unit.



Warning – more information is contained within this guide



Warning – equipment rated above 40°C. Equipment may be very hot.

# Overview

This chapter discusses the following topics:

- LED Indicators
- Switch Model View
- Ports
- Port Status Indicators

The table below gives a brief overview of the models covered in this guide. For more details and for the most up-to-date list of models, please refer to the product pages at [www.perle.com](http://www.perle.com).

Standard Models	Port 1-4	Port 5	Temp
IDS-205F-XXXXXX	10/100/1000Base-T (RJ45)	100Base-X SC/ST fiber	Standard
IDS-205F-XXXXXX-XT	10/100/1000Base-T (RJ45)	100Base-X SC/ST fiber	Industrial

**Note:** xxxxxx denotes the specific type of fiber port installed. Refer to the Perle Website for up to date details on the available options.

# Switch Model View

## IDS-205F

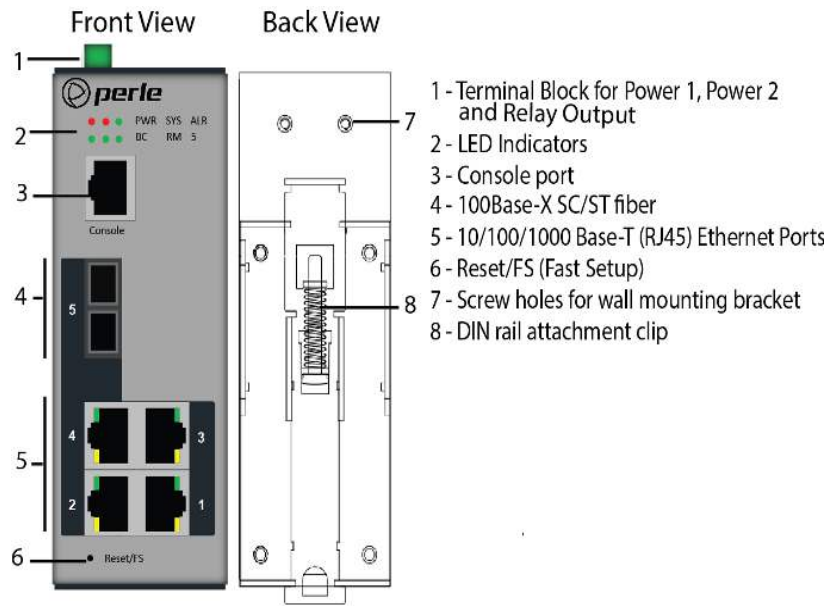

**Note:** Fiber Port may appear different, depending on the type of fiber port installed.

# LED Indicators

## P (Power Inputs)

State	Description
Green	P1 and P2 Power inputs within specifications
Yellow	P1 or P2 Providing power within specifications
Red	Neither P1 or P2 providing power within specifications

## Sys (System Status)

State	Description
Green - blinking (after power on)	System booting
Green - solid	System ready/operating normally
Green - blinking slowly	Fast Setup Mode activated/port available
Green - blinking fast	Fast Setup Mode activated/no port available
Red	Hardware fault or firmware load error

## Alr (Alarm)

State	Description
Off	No alarms configured
Green - solid	Alarms configured, but no alarms detected
Red - solid	Alarm condition detected
Red - blinking	Alarm condition detected and Alarm Relay activated

## BC (Backup Coupling)

State	Description
Off	Backup Coupling not enabled
Green - solid	Backup Coupling Link enabled

## RM (Ring Master)

State	Description
Off	Ring Master not activated
Green - solid	Ring Master Active, redundant port blocked. Coupling Link enabled
Green - flashing	Ring Master unable to establish a ring due to missing link on one of the Ring ports
Yellow - solid	Ring Master Active, redundant port unblocked - indicates a break in the Ring

## 5 (Port 5 - Fiberport Link/Activity)

State	Description
Off	Link Down
Green - blinking	Link and activity
Green - blinking slowly	Port in error disable or suspended state



---

# Ports

## 10/100/1000Base-T Ports

These ports provide the standard gigabit Ethernet interface. They provide speeds of 10/100 or 1000 Mb/s through twisted pair (UTP) cables of up to 100 meters (328ft) in length.

## RJ-45 Console Port

This is a console management port which will provide access to the switch management function using our industry standard CLI command set. This port has an RJ-45 connector. See RJ-45-Console Port Pinouts for pinouts.

## 100Base-X SC/ST Fiber Ports

These ports provide a built in fiber module that provides fiber connectivity at 100 Mb/s. These fiber ports are available on the switches in a variety of distances, wavelengths and connector types. Consult the full model list at [www.perle.com](http://www.perle.com).

## Power Connector

The power input connector has provisions for dual inputs. Two independent power sources can be used to power the switch. If one power input fails, the other power input will power the switch.

## Alarm Relay Connector

The Alarm Relay can be energized by the software or hardware under certain conditions. It can then be used to trigger an external alarm circuit such as a light or sounding device. This connector provides a Normally Closed (NC) dry contact on the connector block.

---

# Port Status Indicators

## Ethernet Port Status Indicators

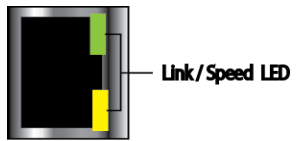

## Port Link / Speed (Green and Yellow LEDs)

State	Description
Green	1000 Mbps
Green / Yellow	100 Mbps
Yellow	10 Mbps
On solid	Port Link
Random blinking	Port Link and Activity
Slow blinking	Error disabled
Rapid blinking	Port in Fast Setup Mode

---

# Installation

This chapter discusses the following topics:

- Cautions and Warnings
- Terminal Block-Power Connectors
- Grounding the IDS Switch
- Connecting Power to the IDS Switch
- Wiring the Relay Alarm
- Connecting the Console Port
- RJ45 Console Port
- Resetting the Password
- Connecting Destination Ports
- Configuring the IDS Switch

## Cautions and Warnings

### General Cautions and Warnings

**Warning:** Power sources must be off prior to beginning the power connection steps. Read the installation instructions before you connect the unit to its power source.

**Warning:** Ensure that the voltage and current ratings of the intended power source are appropriate for the IDS switch as indicated on the product label.

**Warning:** Ensure that the installation and electrical wiring of the equipment is performed by trained and qualified personnel and that the installation complies with all local and national electrical codes.

**Warning:** This unit should be installed in a restricted access location where access can only be gained by service personnel or users who have been instructed about the reasons for the restrictions applied to the location and about any precautions that shall be taken; and access is through the use of a tool or lock and key, or any means of security, and is controlled by the authority responsible for the location.

**Warning:** If the unit is installed vertically in a living or office environment, the device must be operated exclusively in switch cabinets with fire protection characteristics in accordance with EN-60950-1

**Warning:** The working voltage inputs are designed for operation with Safety extra low Voltage (SELV). Connect only to SELV circuits with voltage restrictions in line with IEC/EN 60950-1.

### Hazardous Location Warnings

**Warning:** This equipment shall be installed in an enclosure that provides a degree of protection not less than IP54 in accordance with EN-60079-15 and accessible only by the use of a tool.

**Warning:** The equipment shall only be used in an area of not more than pollution degree 2, as defined in IEC 60664-1.

**Warning:** These devices are open-type devices that are to be installed in an enclosure with tool removable cover or door, suitable for the environment.

**Warning:** This equipment is suitable for use in Class 1, Division 2, Groups A, B, C, D, or only non hazardous locations.

**Warning:** WARNING-EXPLOSION HAZARD - Do not disconnect equipment unless power has been removed or the area is known to be non-hazardous.

**Warning:** WARNING-EXPLOSION HAZARD - Substitution of any components on this switch may impair suitability for Class 1, Division 2.

**Warning:** Transient protection shall be provided that is set at a level not exceeding 140% of the peak rated voltage value at the supply terminals to the equipment.

**Warning:** Ensure power has been removed at the source of the alarm circuit prior to proceeding with the connections to the alarm relay.

**Warning:** Ensure that voltage and current supplied by the alarm circuits are within the stated Alarm Relay specifications.

**Warning:** In hazardous location installations, failure to remove from the source prior to completing the wiring connections to the alarm relay could cause an electrical arc resulting in a possible explosion.

**Warning:** Power supply of the equipment must be rated appropriately (see Appendix for specifications) with limited power. Limited power means complying with one of the following requirements.

Class 2 circuit according to Canadian Electrical Code, Part 1, C22.1

Class 2 circuit according to National Electrical Code, NFPA-70

Limited Power Supply (LPS) according to EN/IEC 60950-1;

Limited-energy circuit according to EN/IEC 61010-1

**Warning:** If this equipment is used in a manner not specified by the manufacturer, the protection provided by the equipment may be impaired.

**Warning:** In case of malfunction or damage, no attempts at repair should be made. Do not dismantle the product. All repairs need to be made by a qualified Perle representative.

**Warning:** Explosion hazard. Do not remove or replace lamps, fuses or plug-in modules (as applicable) unless power has been disconnected or the area is free of ignitable concentrations.

**Warning:** Explosion hazard. Do not disconnect while the circuit is live or unless the area is free of ignitable concentrations.

## Terminal Block-Power Connectors

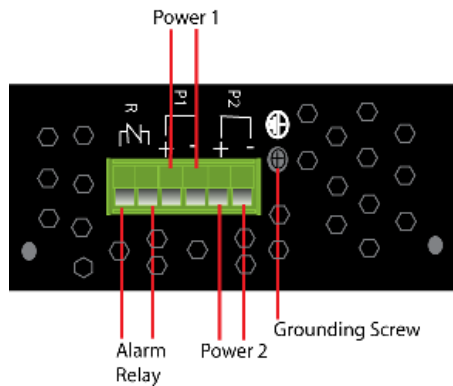

## Grounding the IDS Switch

**Caution:** Minimum temperature rating of the cable to be connected to the field wiring terminals is 105° C.

If your installation requires additional grounding, follow this procedure.

Grounding the chassis requires the following items:

- One grounding lug (not provided)
- One 12 AWG (3.31 mm<sup>2</sup>) wire (not provided)

- 1 Attach the ground wire to the grounding lug; follow the instructions from the ground lug manufacturer.
- 2 Attach the grounding lug to the chassis and secure with the grounding screw provided.

## Connecting Power to the IDS Switch

The IDS switch has two power inputs that can be connected simultaneously to provide redundant power. If one power source fails the other source acts as a backup, and automatically powers the switch. Conductors suitable for use in an ambient temperature of 98° C must be used for the Power Supply Terminals.

- 1 Ensure the power source is off prior to connection.
- 2 Strip 2x12-20AWG (3.31 mm<sup>2</sup> - 0.52 mm<sup>2</sup>) twisted pair copper wires 7-8 mm.
- 3 Loosen the terminal block screws and connect positive (+) / negative (-) wires into the +/- terminals.
- 4 Tighten terminal screws (0.5Nm torque). Ensure the wires are securely fastened.
- 5 Re-insert the Terminal Block connector if removed. Turn on power source. Check LED indicators in the guide for power status.
- 6 Connect P2 (power source 2, beginning at Step 1).
- 7 Ensure that there is one individual conductor for each clamping point.

## Wiring the Relay Alarm

The IDS switch has a Normally Closed (NC) relay with terminals located on the top panel of the unit. The IDS switch can be connected to an external powered device such as a siren or light for visual or audible notification of an alarm status.

- 1 Ensure the power source is off prior to connection.
- 2 Strip 2x12-20AWG (3.31 mm<sup>2</sup> - 0.52 mm<sup>2</sup>) twisted pair copper wires 7-8 mm.
- 3 Loosen the terminal block screws and connect wires into the terminals.
- 4 Tighten terminal screws. Ensure the wires are securely fastened.
- 5 Re-insert the Terminal block connector if removed.
- 6 Turn on power source.

## Connecting the Console Port

The IDS switch can be fully configured and managed from the console port. The console port provides direct access to the Command Line Interface (CLI). See Console Port and RJ45-Console Port Pinouts for proper console port pinouts.

### RJ45 Console Port

The console port uses a shielded cable with an 8-pin female connector (with DTE pinouts).

Front View

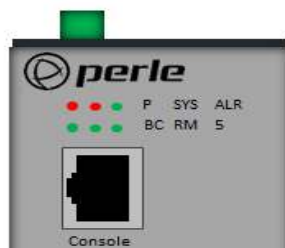

- 1 Connect an RJ45 cable to the IDS switch console port (RJ45) and the other end of the cable to a COM port on your PC.
- 2 Choose Start > Control Panel > Systems or equivalent on the Windows Operating System you are using.

- 3 Click the Hardware tab and choose Device Manager, Expand the Ports(COM & LPT) section. This will expand the drop down to show the number of com ports on your system. Connect the cable to one of these ports (probably com1 or com2).
- 4 Start an terminal-emulation program (such as Putty or SecureCRT) on the COM port where you have connected the cable PC.
- 5 Configure this COM port within the terminal emulation program with the following parameters:
  - 9600 baud
  - 8 data bits
  - 1 stop bit
  - No parity
  - None (flow control)
- 6 Connect power to the switch as described in Connecting Power to the IDS Switch.
- 7 The PC will display the bootloader sequence.
- 8 When the booting (see Booting, Resetting the Switch) of the IDS is completed, press Enter to display the setup prompt.

**Warning:** If you connect or disconnect the console cable with the power applied to the switch or any device on the network, an electrical arc can occur. This could cause an explosion when installed in a hazardous location. Ensure the power is removed from all devices prior to making the cable connection.

## Connecting Destination Ports

### Data Port Connections

By default all of the 10/100/1000 ports will automatically set themselves up to match the speeds of all attached devices. If auto negotiation is not supported by one or more attached devices, the ports can be configured to operate at fixed speeds and duplex settings.

**Warning:** In hazardous location installations, failure to remove the power from the source prior when completing the wiring connections to the Ethernet ports could cause an electrical arc resulting in a possible explosion.

To connect to 10Base-T, 100Base-TX or 1000Base-T follow these steps:

- 1 When connecting to devices, workstations, servers or routers connect a straight through Ethernet cable to a 10/100/1000 RJ45 connector on the front of the IDS switch. Gigabit Ethernet requires CAT5 or better.
- 2 Once the device is connected and link is established the link LEDs will turn on. These LEDs will indicate whether you have a 10,100 or 1000 Mb/s link to the switch. See. (LED Indicators) for more details.

**Note:** It may take a few seconds for the device to become active. By default the IDS switch will have Rapid Spanning Tree (RSTP) protocol enabled. This protocol will first check the network for any cabling loops prior to bringing the port up, in order to prevent network disruptions.

To connect to the 100Base-X Fiber devices:

- 1 Connect a fiber with the appropriate connector and fiber type for the specific IDS model. Ensure that the device being connected to matches the fiber characteristics of the switch.
- 2 Once the fiber is connected and a link is established the LED (5) will display link and activity.

## Resetting the Switch

The Reset/Fast Setup button is located near the bottom of the switch. A small tool such as a paper clip is needed to access the recessed button.

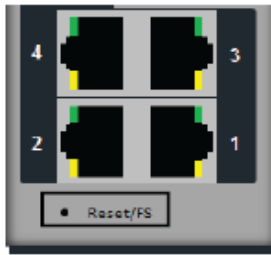

### Soft Reset

To reset/restart the switch you can perform a soft reset. Press and immediately release the reset button to perform a soft reset.

LED	Behavior
PWR	The PWR LED will remain solid yellow during the boot process. Once the system software has been loaded the PWR LED will reflect the status of the power inputs.

### Hard Reset

Hard Reset performs a power-off for the switch without requiring a disconnection of power. Once powered off, the switch can be powered back on by pressing the reset switch again or by disconnecting power at source and re-applying. Press and hold the reset button for at least 8 seconds. The switch will perform a complete power down and stay in the powered off state. Press the reset button to power the switch on.

LED	Behavior
ALL	All LEDs will be off after 8 seconds.

### Reset to Factory Default Configuration

The IDS-205F can be reset to the Factory default configuration. When this is done, all configuration, user IDs, passwords and security certificates are deleted. The start-up and backup software are unaffected. Follow this procedure:

- Power off the switch
- Press and hold the reset button
- While continuing to hold the reset button, apply power to the switch
- ALR LED will go on after power up; when it goes out; release the reset button

The switch is now reset to factory default configuration.

## Booting the Switch

When first applying power to the IDS switch, it will startup and go through the boot process. The LEDs will behave according to the table below.

LED	Behavior
PWR	Yellow during the booting process. Once the system software has been loaded, the PWR LED will reflect the status of the power inputs.
SYS	Green blinking - Boot process underway.

## Fast Setup Mode

This mode allows you to perform initial configuration of the switch using your Web browser. Fast Setup Mode can be activated when the switch is in Factory Default Mode. This mode assigns an IP address to the switch and to a connected PC to permit configuration. Your switch will be shipped to you in Factory default mode. See the Quick Start Guide that came with your IDS switch on how to connect to your switch for the first time.

LED	Behavior
PWR	Press and hold the Reset/FS button. Release button when LED changes from Red to Yellow.
Port Link / Speed	Rapid blinking on the first available RJ-45 port to which the PC can be connected.

## Password Recovery

When the switch is not in factory default the "Fast Setup Mode" sequence will activate Password recovery.

**Note:** The password recovery feature can be disabled in the software.

LED	Behavior
ALR	On solid - during reset process Off - to indicate that reset has completed



---

## Configuring the IDS Switch

The IDS switch can be configured, operated and monitored using any of the following methods. See the IDS User's Guide for more details.

### CLI

A familiar text-based Command Line Interface that is based on accepted industry standard syntax and structure. The CLI can be accessed from the console port. Once a valid IP address is configured on the switch, Telnet or SSH can also be used to access the switch for administration purposes. See the IDS Command Line Reference Guide for more information.

### Web Device Manager

The Perle Web Device Manager is an embedded Web based application that provides an easy to use browser interface for managing the switch. This interface provides the ability to configure and manage the switch. This is accessible through any standard desktop web browser. Requires switch to have a valid IP address.

### Fast Setup

This utility provides the ability to do either an initial setup (out of the box) or a recovery setup. In order to use this utility a PC must be connected to one of the switches data ports and the function is activated using the reset button on the front panel.

### SNMP

The switch can be managed with an SNMP compatible management station that is running platforms such as HP Openview or Perle's PerleVIEW NMS.

# Appendix A - Technical Specifications

This appendix provides the technical specification for the IDS-205F(-XT) switches.

<b>Specifications</b>			
Dual input terminal block		9.6 to 60 VDC SELV, limited-energy per 61010-1 cl.9.4	
Models	Rated Voltage (CLASS 2)	Max. Rated Current	Alarm Relay Output
IDS - 205F(-XT)	9.6 Vdc	0.350A	1.0A at 24Vdc 0.5A at 48Vdc
Rated Cable Temperatures IDS-205F IDS-205F(-XT)		>74°C >90°C	
Overload Current Protection		Fuse	
Reverse Polarity Protection		Yes	
Weight		610 grams	
<b>Interfaces</b>			
10/100/1000Base-T (RJ45)		Industry standard RJ-45 connector	
Fiber 100Base-X		Fixed Fiber (SC/ST) - varies by model	
Console		RJ-45 connector	
LED Indicators		PWR - Power Inputs SYS - System Status ALR - Alarm BC - For Future Use RM - For Future Use 5 - Fiber Port Link/Activity Ports 1-4 G/Y - Link/Activity/Speed	
Reset/FS (Fast Setup) switch		Inset on front panel	
Terminal Block		Rated at 105°C (221°F)	
<b>Environmental</b>			
Operating Temperature Commercial Models (IDS-205F)		-10°C to 60°C (14°F to 140°F) -10°C ≤ TAMB ≤ 60°C	
Industrial Models (IDS-205F-XT)		-40°C to 75°C (-40°F to 167°F) -40°C ≤ TAMB ≤ 75°C	
Storage Temperature Commercial Models (IDS-205F) Industrial Models (IDS-205F-XT)		-25°C to 75°C (-13°F to 167°F) -40°C C to 85°C (-40°F to 185°F)	
Operating Humidity		5% to 90% non-condensing	
Storage Humidity		5% to 95% non-condensing	
Operating Altitude		Up to 3,048 m (10,000 ft)	

IP Ingress Protection	IP20
<b>Regulatory Approvals</b>	
Standard Safety	cUL 60950-1, EN 60950, EN/IEC 60950
Industrial Safety	UL 61010-1, UL 61010-2-201 EN 61010-1, EN 61010-2-201
EMI/EMC	FCC 47 Part 15 - Class A CISPR22:2008 / EN55022:2010 Class A CISPR 24:2010/EN55024:2010
Standard emissions	FCC 47 Part 15 Class A CISPR 22:2008/EN55022:2010(Class A) CISPR 24:2010EN 55024:2010
Hazloc (Hazardous locations)	ANSI/ISA 12.12.01 Class1 Division 2 Groups A-D A TEX Class 1 Zone 2
Minimum EMC and Immunity	EN/IEC 61000-4-2(ESD); Contact discharge +/- 6kV Air Discharge +/- 8kV EN/IEC 61000-4-4(EFT); DC power line, +/- 2kV, Data line +/- 4kV EN/IEC 61000-4-5(SURGE); DC power line Line/Line +/- 4kV, Line/Earth +/- 2kV, Data line/earth +/- 2kV EN/IEC 61000-4-6 (CS); 150kHz to 80 MHz: 10V EN/IEC 61000-4-8 (Magnetic Field) EN/IEC 61000-6-2 (General Immunity)
Laser Safety	EN 60825-1:2007 FDA/CDRH 21 CFR1040.10/CFR1040.11
IEEE Compliance	802.3-10BaseT 802.3u-100Base-TX 100BaseFX 802.3x-Flow Control 802.3z-1000BaseLX 802.3ab-1000BaseTX

Note: The safety certifications apply only to ambient temperatures under 60°C (140°F). However, the IDS switch can function in the environmental conditions listed above.

## Contacting Technical Support









Contact information for the Perle Technical Assistance Center (PTAC) can be found at the link below. A Technical Support Query may be made via this webpage.  
[www.perle.com/support\\_services/support\\_request.shtml](http://www.perle.com/support_services/support_request.shtml)



## Warranty / Registration

This product is covered by the Perle Ethernet Switches Warranty. Details can be found at:  
[https://www.perle.com/support\\_services/warranty.shtml](https://www.perle.com/support_services/warranty.shtml)

# Appendix B - Labels

## IDS-205F

  
 Model: IDS-205F-CMD2  
 P/N: 07012050  
 S/N: 326-012616T00088  
  





  
 Input : 9.6-60VDC, 0.35A max, Class2  
 MAC : 004002910104

		
<p>           DEMKO 16 ATEX 1636X            II 3 G Ex nA nC IIC T5 Gc            -10°C ≤ Tamb ≤ 60°C            Rated Cable Temp. &gt;74°C            60 Renfrew Drive,            Markham, Ontario,            Canada. L3R 0E1         </p>	<p>           IND. CONT. EQ.            FOR HAZ. LOC.            Class I, Division 2,            Groups A, B, C and D            Temp Code: T5            Max. Ambient 60 Deg. C            Min. Ambient -10 Deg. C         </p>	<p>           IND. CONT. EQ.            Surrounding Air Temp:            Max. 60 Deg. C            Min. -10 Deg. C            Made in Canada         </p>

Class 1 Laser Product: IEC 60825-1

## IDS-205F-XT

  
 Model: IDS-205F-CMD2-XT  
 P/N: 07012250  
 S/N: 326-212616T00093  
  





  
 Input : 9.6-60VDC, 0.35A max, Class2  
 MAC : 004002910136

		
<p>           DEMKO 16 ATEX 1636X            II 3 G Ex nA nC IIC T4 Gc            -40°C ≤ Tamb ≤ 75°C            Rated Cable Temp. &gt;90°C            60 Renfrew Drive,            Markham, Ontario,            Canada. L3R 0E1         </p>	<p>           Class I, Division 2,            Groups A, B, C and D            Temp Code: T4            Max. Ambient 75 Deg. C            Min. Ambient -40 Deg. C         </p>	<p>           IND. CONT. EQ.            Surrounding Air Temp:            Max. 75 Deg. C            Min. -40 Deg. C            Made in Canada         </p>

Class 1 Laser Product: IEC 60825-1

# Appendix C - Mechanical Drawings

## 5-port RJ-45

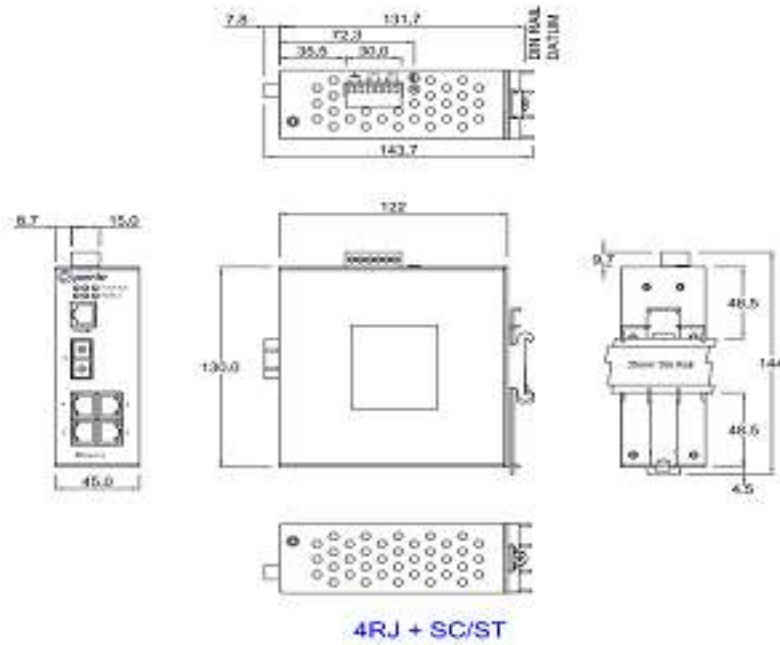

# Appendix D - IDS DIN Rail and Wall Mounting

This appendix provides instruction on the following:

- Mounting the IDS Switch on a DIN Rail
- Removing the IDS from the DIN Rail
- Wall Mounting the IDS

## Mounting the IDS Switch on a DIN Rail

- 1 The DIN rail clip will be fixed to the back of the IDS unit when you receive the switch.
- 2 Position the IDS switch such that the top hooks of the DIN rail clip attach onto the top of the DIN rail.
- 3 Rotate the bottom of the IDS switch towards the rail. This will snap the bottom hooks of the DIN rail clip onto the bottom of the DIN rail.

See diagram below



## Removing the IDS from the DIN Rail

- 1 The DIN rail attachment clip has a slot at the bottom of the latch that is visible beneath the switch when it is mounted.
- 2 Insert a flat blade screwdriver into the slot and twist the base to release the clip. Alternatively a downward force on the clip will release the clip.
- 3 When the clip is released, pull the bottom of the switch out slightly and remove the switch from the DIN rail.

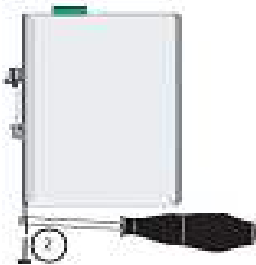

## Wall Mounting the IDS

If you have purchased the optional wall mounting kit then proceed as below:

- 1 Remove the DIN rail clip from the rear panel on the IDS switch.
- 2 Attach the wall mount plates to the IDS switch as shown below using the screws provided in the kit.

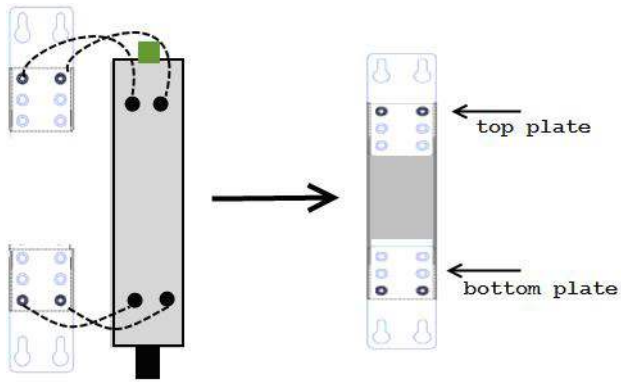

- 3 Use the wall mount plates as a guide to mark the spot where the screws will be placed.
- 4 Drive the screws into the wall leaving about 2 mm of the screw protruding from the wall to allow room for sliding the wall mount panel between the wall and the screws.
- 5 Once the screws are fixed to the wall, insert the four screw heads through the large parts of the keyhole shaped screw openings
- 6 Pull the IDS switch down to lock the IDS switch to the wall mount.
- 7 Tighten the four screws securely to the wall.

**Note:** for best results use screws with the following attributes Head diameter .5 - .6 mm  
Shaft diameter 3 -3.5 mm

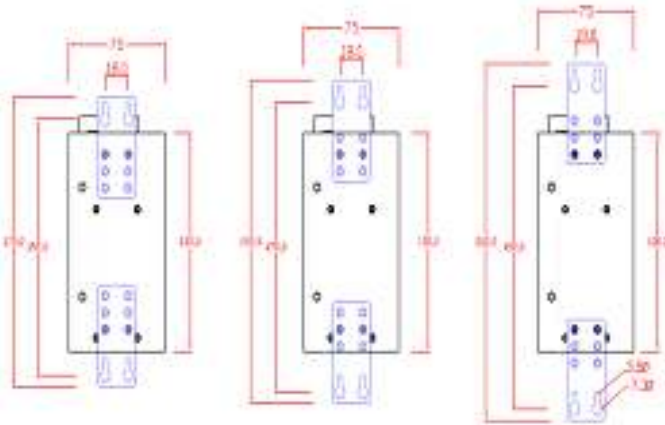

---

## Appendix E - IDS Maintenance

- Ensure there is clearance of 50.8mm (2 inches) on all sides of the IDS switch to provide proper airflow through the unit
- Do not use solvents or cleaning agents on this unit
- Keep vent holes clear of debris
- If case gets dirty wipe with a dry cloth
- Ensure all cables are in good working condition
- Replace any frayed cables or cables without clips



# Appendix F - Cables and Connectors

This appendix discusses the following topics:

- RJ45-Console Port Pinouts:
- Ethernet cables
- Ethernet Connector - 8 pin RJ45
- Fiber Port Cabling Requirements

## RJ45-Console Port Pinouts

The console port uses a shield cable with an 8-pin female connector (with DTE pinouts).

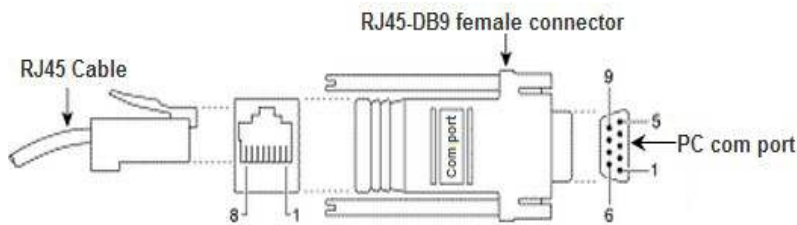

RJ-45 Console	Function	Direction
1	RTS	OUT
2	DTR	OUT
3	TXD	OUT
4	GND	-
5	GND	-
6	RXD	IN
7	DSR	IN
8	CTS	IN

## Ethernet Cables

The 10/100/1000BaseT(X) ports located on the IDS switch's front panel are used to connect to Ethernet-enabled devices. These Ethernet ports will automatically adjust depending on the type of Ethernet cable used (straight-through or cross-over), and the type of device (NIC-type or HUB/Switch-type) connected to the port.

### Requirements:

- Cat 5 UTP or STP, Cat 5e cables
- 24-22 AWG (0.20mm<sup>2</sup> - 0.33mm<sup>2</sup>)
- Straight through or Ethernet Crossover cable

**Note:** An optional cable adapter is available to provide RJ45 to DB9 conversion: Perle's optional RJ45 to DB9-F crossover adapter model DB0020C enables a straight through Ethernet cable to connect the RJ45 console port to a PC serial port.

## Ethernet Connector - 8-pin RJ-45

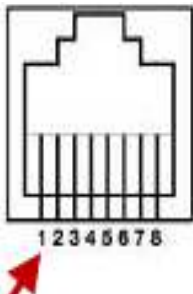

### MDI Port Pinouts

Pin	Signal
1	Tx+
2	Tx-
3	Rx+
6	Rx-

### MDI-X Port Pinouts

Pin	Signal
1	Rx+
2	Rx-
3	Tx+
6	Tx-

## Fiber Port Cabling Requirements

### Duplex SC or ST Connector

- Multimode 50/125 or 62.5/125 micron fiber cable
- Single mode 9/125 micron fiber cable

### Simplex (BIDI, single strand) SC or ST connector

- Multimode 50/125 or 62.5/125 micron fiber cable
- Single mode 9/125 micron fiber cable

Connect the fiber cable to Port 5 on the IDS switch and the other end to a compliant fiber device. If you are making your own fiber cables, remember that the RX on one side needs to go to TX on the other side and vice versa. See diagram below.

