



MAX5661 Evaluation Kit/Evaluation System

General Description

The MAX5661 evaluation kit (EV kit) is a fully assembled and tested circuit board that evaluates the MAX5661, single, 16-bit DAC with precision high-voltage amplifiers. The MAX5661 EV kit also includes Windows® 98SE/2000/XP-compatible software, which provides a simple graphical user interface (GUI) for exercising the MAX5661's features.

The MAX5661 evaluation system (EV system) consists of a MAX5661 EV kit and a Maxim CMAXQUSB+ serial interface board.

The CMAXQUSB+ board connects to a PC's USB port and provides an SPI™ interface that is compatible with the MAX5661.

Order the complete EV system (MAX5661EVCMAXQU+) for a comprehensive evaluation of the MAX5661 using a PC. Order the EV kit (MAX5661EVKIT+) if the CMAXQUSB+ command module has already been purchased with a previous Maxim EV system or if you already have a MAX5661-compatible SPI interface.

The EV kit includes a preinstalled MAX5661GCB+.

Windows is a registered trademark of Microsoft Corp.

SPI is a trademark of Motorola, Inc.

Features

- ◆ 10-Bit Programmable Full-Scale Output Adjustment for Up to $\pm 25\%$ Over Range
- ◆ Programmable Voltage Output
Unipolar Range: 0 to +10.24V $\pm 25\%$
Bipolar Range: $\pm 10.24V \pm 25\%$
- ◆ Programmable Current Output
Unipolar Range: 0 to 20.45mA
Unipolar High Range: 3.97mA to 20.45mA
- ◆ Flexible Analog Supplies
 $\pm 13.48V$ to $\pm 15.75V$ for Voltage Output
 $+13.48V$ to $+40V$ for Current Output
- ◆ Proven PCB Layout
- ◆ Windows 98SE/2000/XP-Compatible Evaluation Software
- ◆ Fully Assembled and Tested
- ◆ EV System Includes USB Connectivity

Ordering Information

PART	TYPE	INTERFACE
MAX5661EVKIT+	EV Kit	User-supplied SPI interface
MAX5661EVCMAXQU+	EV System	CMAXQUSB+ board

+Denotes lead(Pb)-free and RoHS compliant.

Note: The MAX5661 EV kit software is included with the MAX5661 EV kit but is designed for use with the complete EV system. The EV system includes both the Maxim CMAXQUSB+ board and the EV kit. If the Windows software will not be used, the EV kit board can be purchased without the Maxim CMAXQUSB+ board.

Component Lists

MAX5661 EV System

PART	QTY	DESCRIPTION
MAX5661EVKIT+	1	MAX5661 EV kit
CMAXQUSB+	1	Serial-interface board

MAX5661 EV Kit

DESIGNATION	QTY	DESCRIPTION
C1, C4, C6, C11, C13	5	0.1 μ F $\pm 10\%$, 16V X7R ceramic capacitors (0402) TDK C1005X7R1C104K
C2, C3	2	0.1 μ F $\pm 10\%$, 50V X7R ceramic capacitors (0603) TDK C1608X7R1H104K
C5	1	0.022 μ F $\pm 10\%$, 50V X7R ceramic capacitor (0603) TDK C1608X7R1H223K
C7	1	2.2 μ F $\pm 10\%$, 6.3V X5R ceramic capacitor (0603) TDK C1608X5R0J225K

DESIGNATION	QTY	DESCRIPTION
C8	1	3300pF $\pm 5\%$, 50V C0G ceramic capacitor (0603) TDK C1608C0G1H332K
C9, C16	2	10 μ F $\pm 20\%$, 50V X7R ceramic capacitors (2220) TDK C5750X7R1H106K
C10, C15, C17, C18	4	10 μ F $\pm 20\%$, 16V X7R ceramic capacitors (1206) TDK C3216X7R1C106K
C12	1	1 μ F $\pm 10\%$, 16V X7R ceramic capacitor (0805) TDK C2012X7R1C105K
C14	1	1 μ F $\pm 10\%$, 16V X7R ceramic capacitor (0603) TDK C1608X7R1C105K
D1	1	30V Schottky diode (SOD323) Central Semi CMDSH2-4L
D2	1	33V zener diode (SOD123) Central Semi CMHZ5257B



MAX5661 Evaluation Kit/Evaluation System

Component List (continued)

DESIGNATION	QTY	DESCRIPTION
J1	1	2 x 20 right-angle socket
J2	1	6-pin header
JU1–JU4, JU6, JU7, JU8, JU10, JU11	9	2-pin headers
JU5, JU12	2	3-pin headers
R1	1	499 \pm 1%, 1/2W resistor (through hole)
R5, R8, R10	3	47 \pm 5% resistors (0603)
R7, R9, R13, R14	4	47k \pm 5% resistors (0402)
R11	1	1.3k \pm 5% resistor (0402)
R12	1	2k \pm 1%, 1/2W resistor (through hole)
R15	1	2k \pm 5% resistor (0402)
U1	1	Maxim MAX5661GCB+ (64 LQFP)
U2	1	Maxim MAX6241AES (8 SO)
—	7	Shunts
—	1	PCB: MAX5661 Evaluation Kit+

Quick Start

Recommended Equipment

- The MAX5661 EV system
 - MAX5661 EV kit
 - CMAXQUSB+ command module (USB cable included)
- One +5V power supply for VCC (VCC power supply)
- One +15V power supply for VDDI and VDDV (VDD power supply)
- One -15V power supply for VSSV (VSS power supply)
- Two digital voltage meters (OUTI voltage meter and OUTV voltage meter)
- One digital current meter (OUTI current meter)
- A user-supplied Windows 98SE/2000/XP PC with a spare USB port

Note: In the following sections, software-related items are identified by bolding. Text in **bold** refers to items directly from the EV kit software. Text in **bold and underlined** refers to items from the Windows operating system.

Procedure

- Visit www.maxim-ic.com/evkitsoftware to download the most recent revision of the EV kit software, 5661Rxx.ZIP. Save the EV kit software to a temporary folder and unzip the 5661Rxx.ZIP file

Component Suppliers

SUPPLIER	PHONE	WEBSITE
Central Semiconductor Corp.	631-435-1110	www.centalsemi.com
TDK Corp.	847-803-6100	www.component.tdk.com

Note: Indicate that you are using the MAX5661 when contacting these component suppliers.

MAX5661 EV Kit Files

FILE	DESCRIPTION
INSTALL.EXE	Installs the EV kit files on your computer
MAX5661.EXE	Application program
FTD2XX.INF	USB device driver file
UNINST.INI	Uninstalls the EV kit software
TROUBLESHOOTING_USB.PDF	USB driver installation help file

- Install the MAX5661 EV kit software on your computer by running the INSTALL.EXE program inside the temporary folder. The program files are copied and icons are created in the Windows **Start** menu.
- Preset the VCC power supply to +5V. Turn off the power supply.
- Preset the VDD power supply to +15V. Turn off the power supply.
- Preset the VSS power supply to -15V. Turn off the power supply.

Do not turn on the power supply until all connections are completed.

- On the CMAXQUSB+ command module, ensure the shunt of JU1 is in the 5V position. Refer to CMAXQUSB+ user's guide.
- On the EV kit, make sure the shunts of all jumpers are in positions, as shown in Table 1.
- Carefully connect the boards by aligning the MAX5661 EV kit's 40-pin connector with the CMAXQUSB+ board's 40-pin connector. Gently press them together. The two boards should be flush against each other.
- Connect the positive terminal of the VCC power supply to the VCC pad on the EV kit and connect the negative terminal of the VCC power supply to the PGND pad on the EV kit.

MAX5661 Evaluation Kit/Evaluation System

Table 1. MAX5661 EV Kit Jumper Functions

JUMPER	LABELED	POSITION	FUNCTION
JU1	$\overline{\text{CLR}}$	Open*	Normal operation
		1-2	Loads DAC register from DAC clear register or zero
JU2	$\overline{\text{LADC}}$	Open*	Normal operation
		1-2	Loads DAC register from DAC input register
JU4, JU3	CFG1, CFG0	Open, Open*	Outputs controlled by serial interface
		Open, 1-2	OUTV on, set to bipolar mode
		1-2, Open	OUTI on, set to 0 to 20mA range
		1-2, 1-2	Both outputs disabled
JU5	4TO20MA	1-2	Selects OUTI range from 3.97mA to 20.45mA
		2-3*	Selects OUTI range from 0 to 20.45mA
JU6	ILD	Open	OUTI without loading resistor
		1-2*	OUTI with 500 Ω loading resistor
JU7	VCLD	Open	OUTV without loading capacitor
		1-2*	OUTV with 1 μ F loading capacitor
JU8	VRLD	Open	OUTV without loading resistor
		1-2*	OUTV with 2k Ω loading resistor
JU10	SEN+	Open	Connects voltage-sense input SEN+ remotely
		1-2*	Connects voltage-sense input SEN+ to the top terminal of the loading resistor on the board
JU11	SEN-	Open	Connects voltage-sense input SEN- remotely
		1-2*	Connects voltage-sense input SEN- to GND on the board
JU12	VICV	1-2*	VDDC connects to VDDI
		2-3	VDDC connects to VDDV

*Indicates default position.

- 10) Connect the positive terminal of the VDD power supply to both the VDDI and the VDDV pads on the EV kit and connect the negative terminal of the VDD power supply to the PGND pad on the EV kit.
- 11) Connect the NEGATIVE terminal of the VSS power supply to the VSSV pad on the EV kit and connect the POSITIVE terminal of the VSS power supply to the PGND pad on the EV kit.
- 12) Connect the positive lead of the OUTI voltage meter to the OUTI pad on the EV kit and connect the negative lead of the OUTI voltage meter to the GND pad on the EV kit.
- 13) Connect the positive lead of the OUTV voltage meter to the OUTV pad on the EV kit and connect the negative lead of the OUTV voltage meter to the GND pad on the EV kit, which is above the OUTV pad.
- 14) Connect the positive lead of the OUTI current meter to the OUTI pad on the EV kit and connect the negative lead of the current meter to the ILOAD pad on the EV kit. Remove the shunt of JU6.
- 15) Turn on all three power supplies. Sequence is not important.
- 16) Connect the USB cable from the PC to the CMAXQUSB+ board. **A Building Driver Database** window should pop up in addition to a **New Hardware Found** message if this is the first time the EV kit board is connected to the PC. If you do not see a window that is similar to the one described above after 30s, try removing the USB cable from the CMAXQUSB+ and reconnect it. Administrator privileges are required to install the USB device driver on Windows 2000 and XP. Refer to the document TROUBLESHOOTING_USB.PDF included with the software if you have any problems during this step.
- 17) Follow the directions of the **Add New Hardware Wizard** to install the USB device driver. Choose the **Search for the best driver for your device** option.

MAX5661 Evaluation Kit/Evaluation System

Specify the location of the device driver to be **C:\Program Files\MAX5661** (default installation directory) using the **Browse** button.

- 18) Start the MAX5661 EV kit software by opening its icon in the **Start** menu.
- 19) Check the **outv_on** checkbox then press the **Execute Write** button.
- 20) Enter 0xBE80 in the **Input of Shift Register** edit box and select **Actions | Load DAC Input Register and DAC Register from Shift Register** next to the **Input of Shift Register** group box. Verify the OUTV voltage is approximately 5.0V.

Detailed Description of Software

The evaluation software's main window is shown in Figure 1. There are five register group boxes and one **Actions** drop-down list in the main window. The five register group boxes are **Control_Bits Register**, **DAC**

Input Register, **DAC Register**, **Clear Register**, and **Input of Shift Register**.

Control_Bits Register

The **Control_Bits Register** group box contains 14 individual control bits, 4 of them are read only. Under the **Execute Read** button, there is one set of 14 grayed-out checkboxes that represent the read-back status of those 14 control bits. Under the **Execute Write** button, there is another set of 14 checkboxes for the user to configure the IC. Four of them have been grayed out since they are read only. The name of each checkbox is listed in between the two columns of checkboxes. On the right side are the detailed descriptions for each checkbox.

A fault status indicator is located on the right side of the last three checkboxes. It indicates the current status of the MAX5661's **FAULT** pin and it is updated every second. It only works if the **out_fault_en** checkbox has been checked.

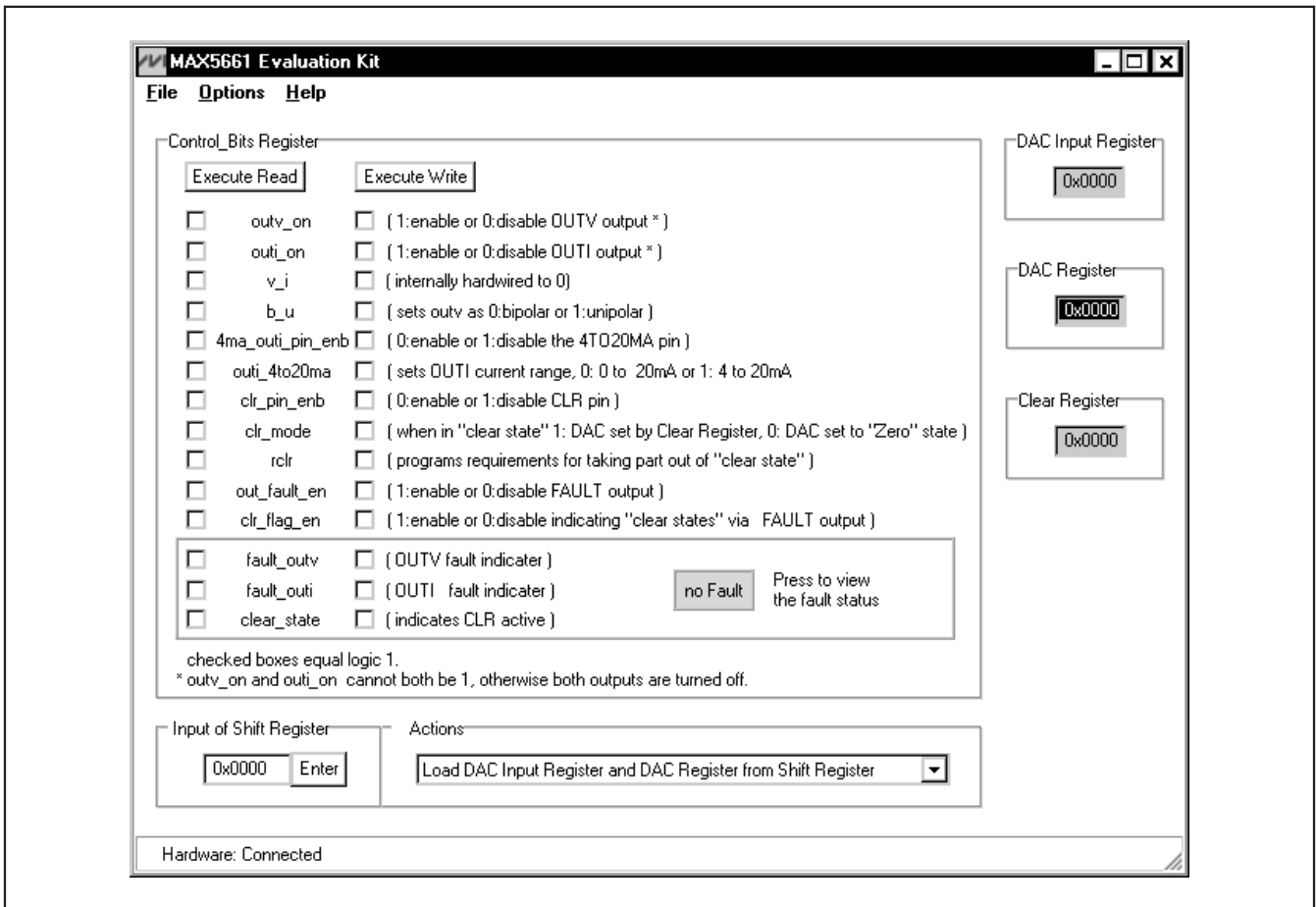

Figure 1. MAX5661 Evaluation Software Main Window

MAX5661 Evaluation Kit/Evaluation System

Evaluate: MAX5661

DAC Input Register, DAC Register, and Clear Register Group Boxes

DAC Input Register, DAC Register, and Clear Register display the current contents of these registers. Any change in the **Actions** drop-down list updates these registers.

Input of Shift Register Edit Box and Actions Drop-Down List

Input the value in the **Input of Shift Register** edit box and use the **Actions** drop-down list to choose the desired action as shown in Figure 2.

Detailed Description of Hardware

MAX5661 EV System

The MAX5661 EV system consists of a MAX5661 EV kit and the Maxim CMAXQUSB+ serial interface board.

CMAXQUSB+ Board

The CMAXQUSB+ serial interface board is a command module that receives commands from a PC through the USB port to create an SPI or SMBus™/I²C-compatible interface.

CMAXQUSB+ Power Supply

Jumper JU1 of the CMAXQUSB+ board selects between the 5V DC voltage that comes from the USB connector and the MAX8511 regulated 2.5V or 3.3V output voltages. Set the CMAXQUSB+ jumper JU1 at the 5V position to evaluate the MAX5661 EV kit.

MAX5661 EV Kit

The MAX5661 EV kit board provides a proven layout for evaluating the MAX5661. The EV kit comes with MAX5661GCB+.

SMBus is a trademark of Intel Corp.

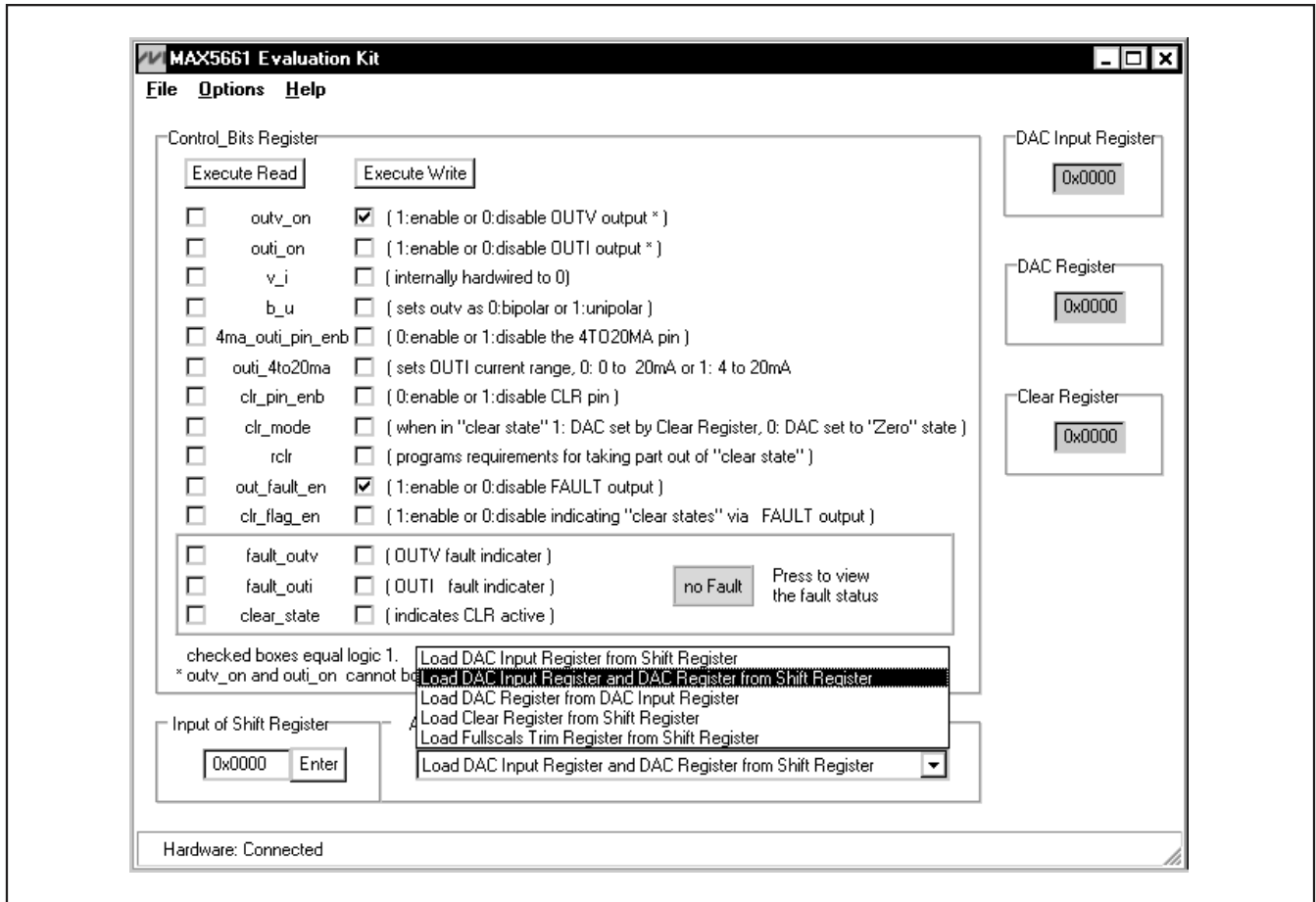

Figure 2. Actions Drop-Down List

MAX5661 Evaluation Kit/Evaluation System

MAX5661 EV Kit Power Supply

There are five different power-supply pads on the MAX5661 EV kit board. They are VCC, VDDV, VDDI, VSSV, and VDDC.

The MAX5661 EV kit provides current-output and voltage-output configurations. However, only one output is active at any given time regardless of the configuration. Unused outputs do not require a power-supply voltage. Do not leave power-supply inputs unconnected. Connect unused supply inputs to PGND (see Table 2).

The VDDC supplies the MAX5661 DAC core. It can be connected to either VDDI or VDDV through jumper JU12 as shown in Table 1.

The VCC powers the rest of the MAX5661 internal circuitry. The range of VCC is from +4.75V to +5.25V.

OUTI Load Resistor and Related Jumper

There is a 499 Ω load resistor on the EV kit board for the current output. Jumper JU6 controls it either by connecting or disconnecting to the current output as shown in Table 1.

OUTV Load Capacitor, Load Resistor, Sensors, and Related Jumpers

There is a 1 μ F load capacitor and a 2k Ω load resistor on the EV kit board for the voltage output. Jumper JU7 connects the load capacitor to the voltage output and jumper JU8 connects the load resistor to the voltage output as shown in Table 1.

Jumper JU10 connects the sense input SEN+ to the OUTV pad on the MAX5661 EV kit board and JU11 connects the sense input SEN- to the GND pad next to the OUTV pad. See Table 1 for jumper settings.

Configuration and Setting Jumpers

$\overline{\text{LDAC}}$ and $\overline{\text{CLR}}$ inputs allow asynchronous updates of the MAX5661 DAC output. The MAX5661 EV kit's jumper JU1 controls the $\overline{\text{CLR}}$ input pin of the MAX5661 and jumper JU2 controls the $\overline{\text{LDAC}}$ input pin as shown in Table 1. Shorting JU1 sets the DAC code to the value stored in the DAC clear register or to zero-scale. The function of the $\overline{\text{CLR}}$ pin can be enabled or disabled by software using the `clr_pin_enb` bit. Shorting JU2 updates the DAC outputs with the data stored in the input register.

Jumpers JU3 and JU4 control configuration inputs CNF0 and CNF1. These two inputs determine which output of the MAX5661 is enabled as shown in Table 1. Leave both jumpers open to use the serial interface to control the output configuration.

Table 2. Operating Modes and Supply Voltage Limits

MODE	VDDV (V)	VSSV (V)	VDDI (V)	VDDC
Voltage from OUTV	+13.25 to +15.75	-13.25 to -15.75	VDDV	VDDV
Current from OUTI	PGND	PGND	+12 to +40	VDDI
Voltage from OUTV and Current from OUTI*	+13.25 to +15.75	-13.25 to -15.75	VDDV to +24	VDDV

*On-the-fly switching. Only one output is active at a time.

MAX5661 Evaluation Kit/Evaluation System

Evaluate: MAX5661

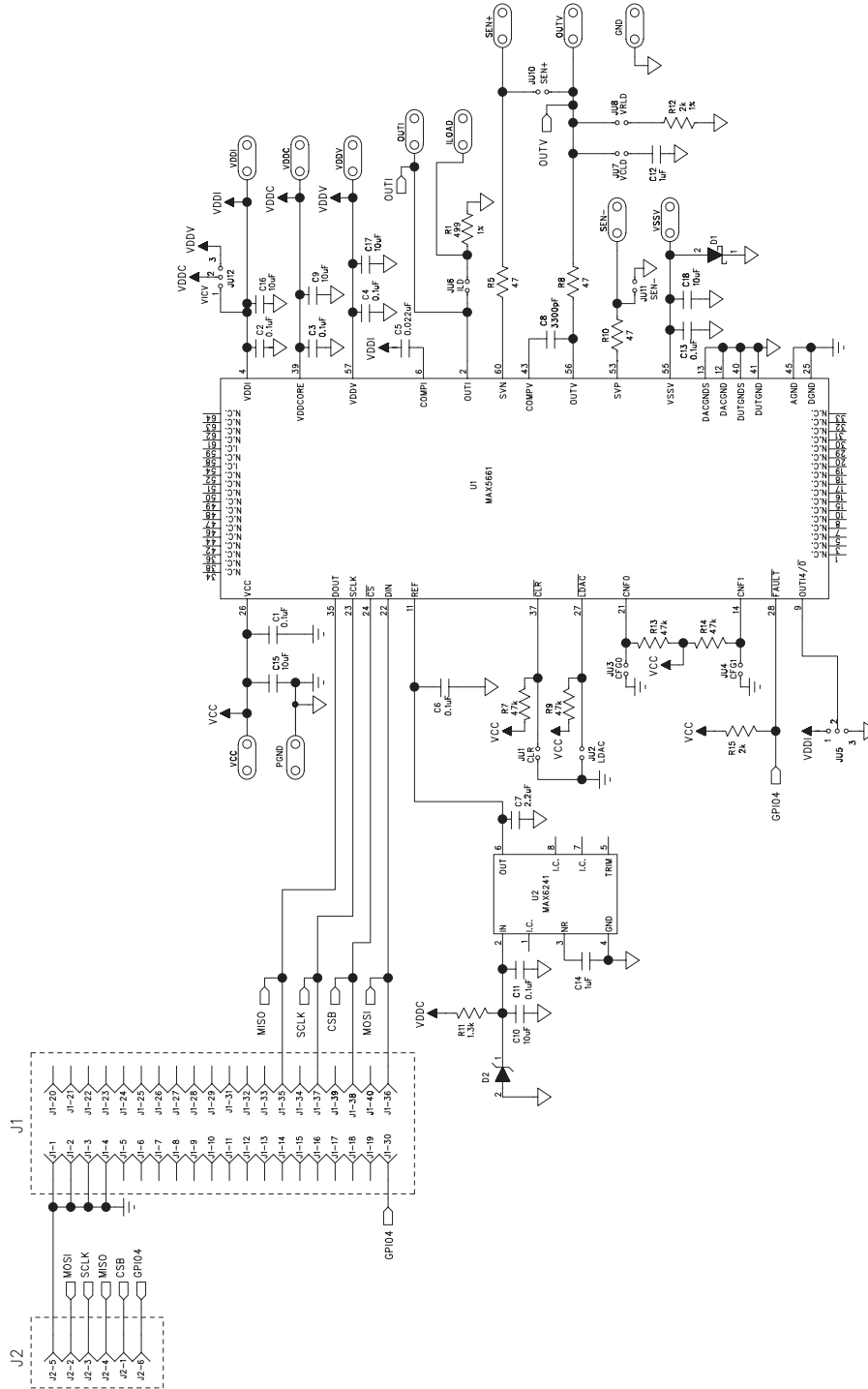

Figure 3. MAX5661 EV Kit Schematic

MAX5661 Evaluation Kit/Evaluation System

Evaluate: MAX5661

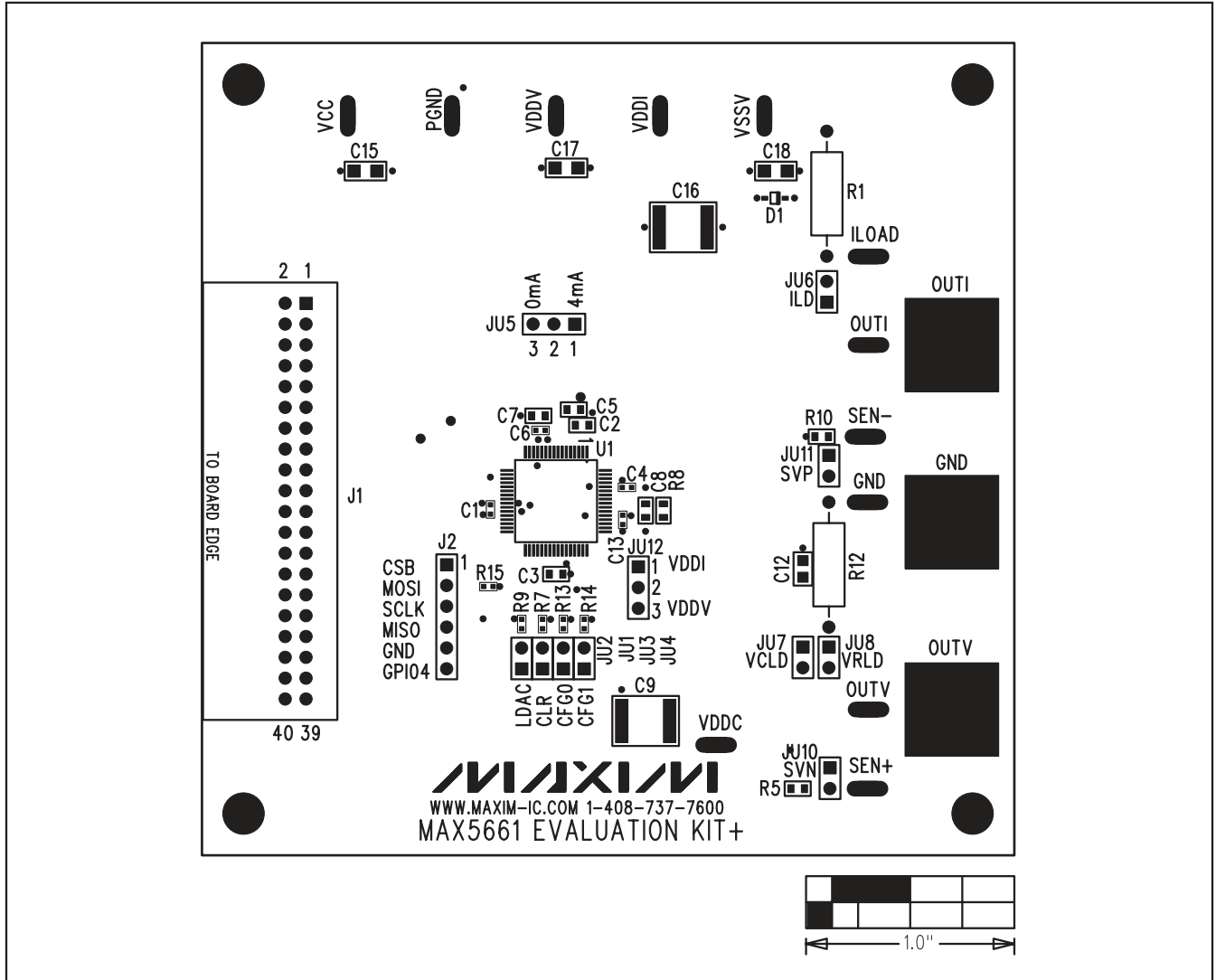

Figure 4. MAX5661 EV Kit Component Placement Guide—Component Side

MAX5661 Evaluation Kit/Evaluation System

Evaluate: MAX5661

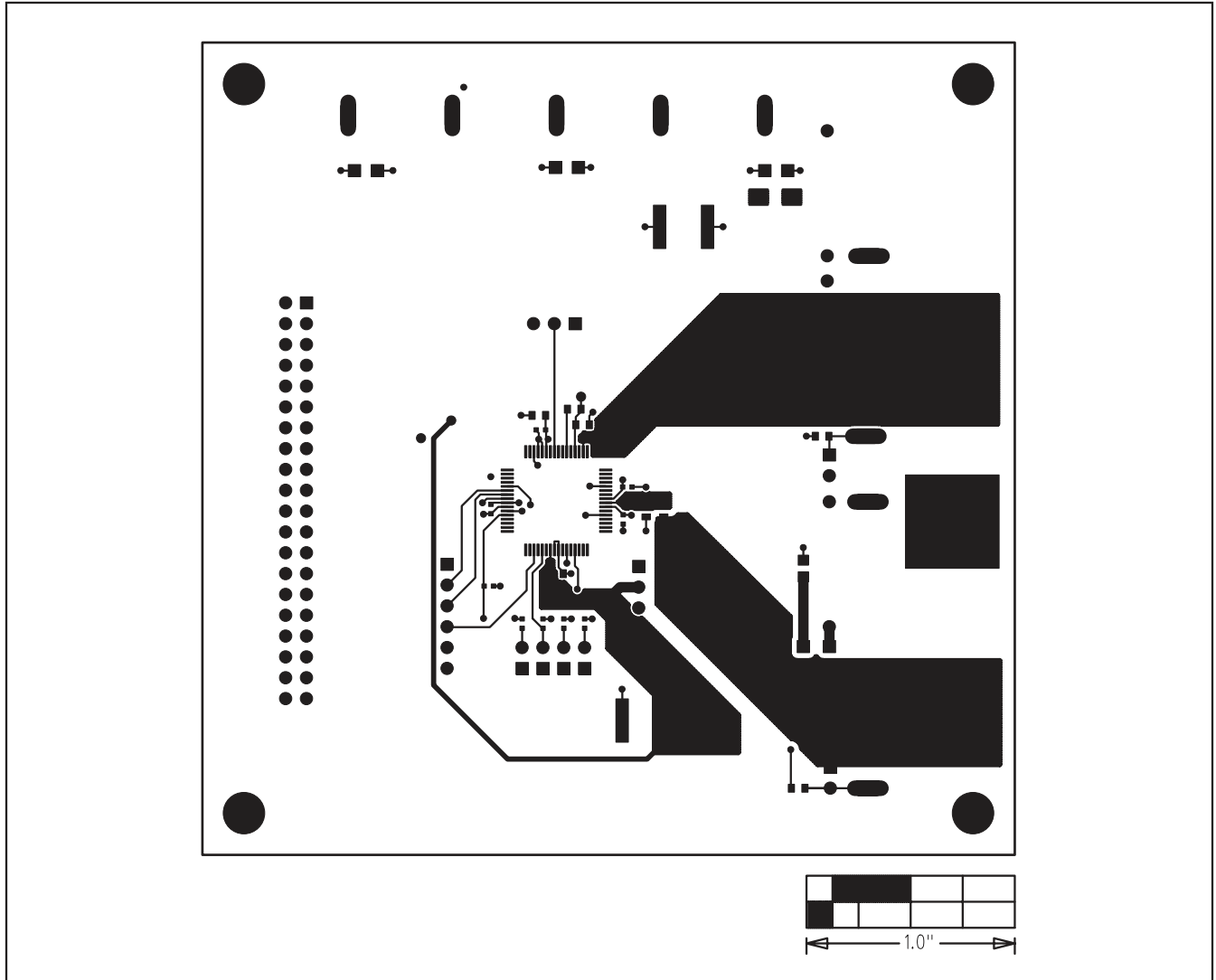

Figure 5. MAX5661 EV Kit PCB Layout—Component Side

MAX5661 Evaluation Kit/Evaluation System

Evaluate: MAX5661

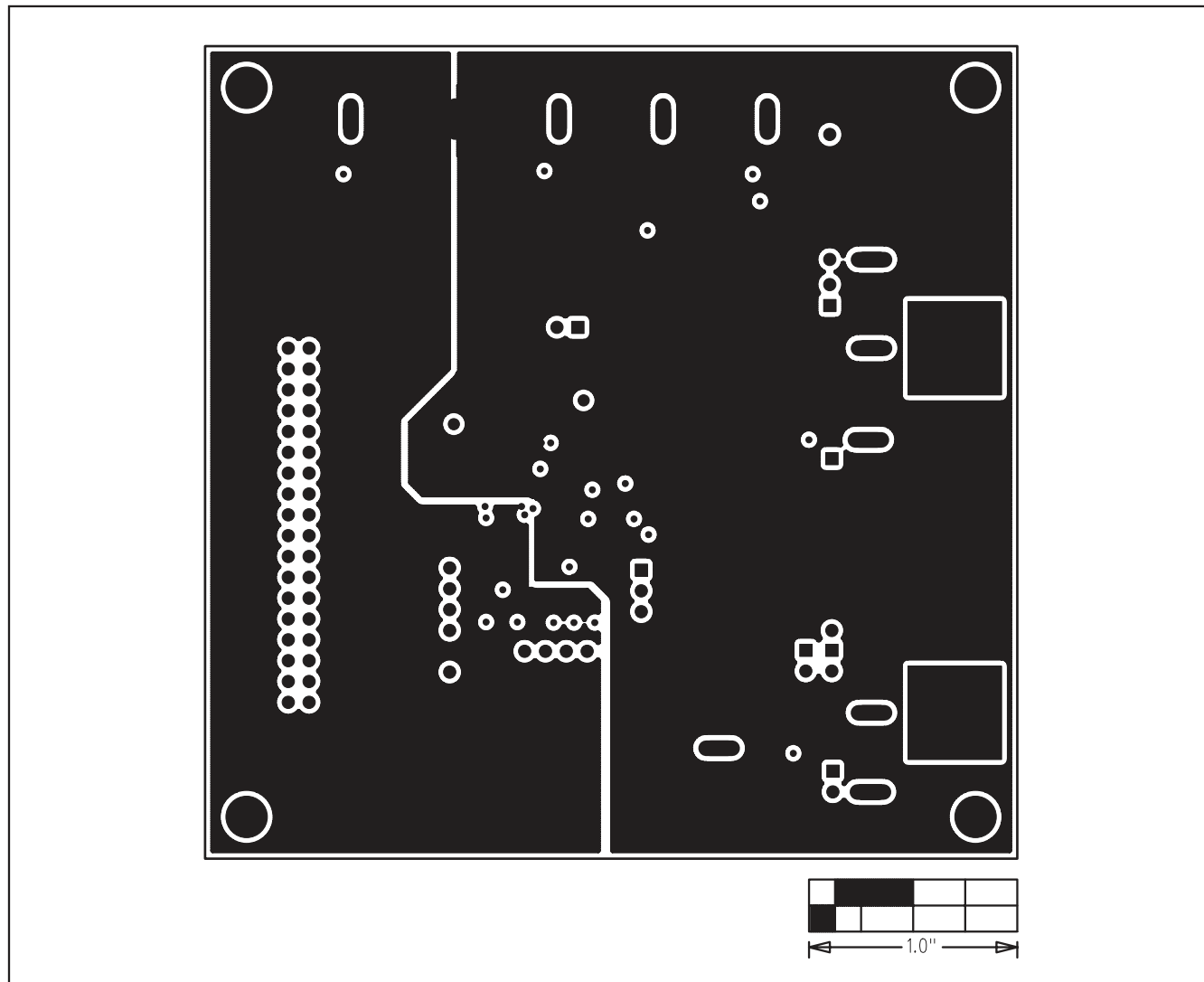

Figure 6. MAX5661 EV Kit PCB Layout—Layer 2 (GND)

MAX5661 Evaluation Kit/Evaluation System

Evaluate: MAX5661

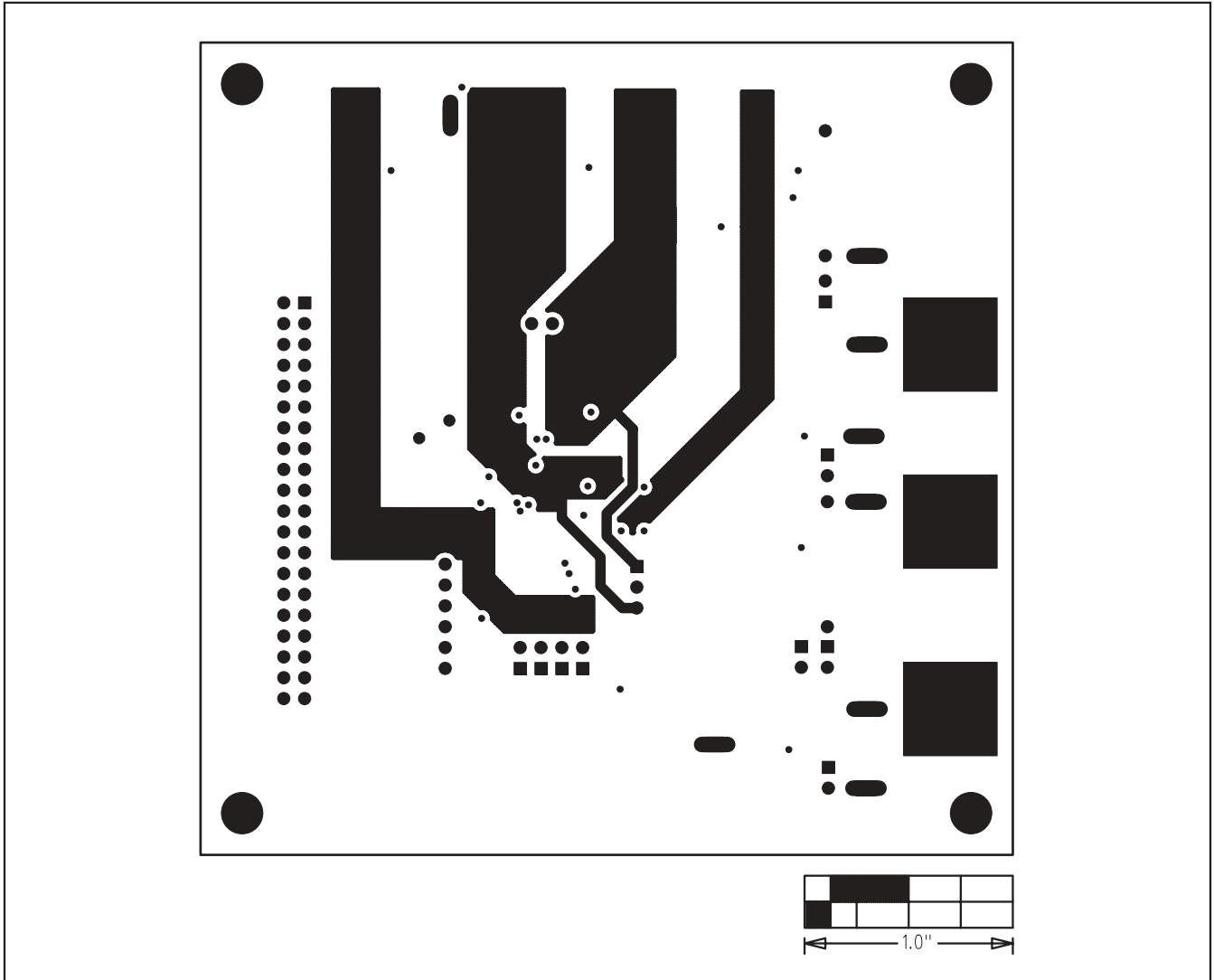

Figure 7. MAX5661 EV Kit PCB Layout—Layer 3 (Power)

MAX5661 Evaluation Kit/Evaluation System

Evaluate: MAX5661

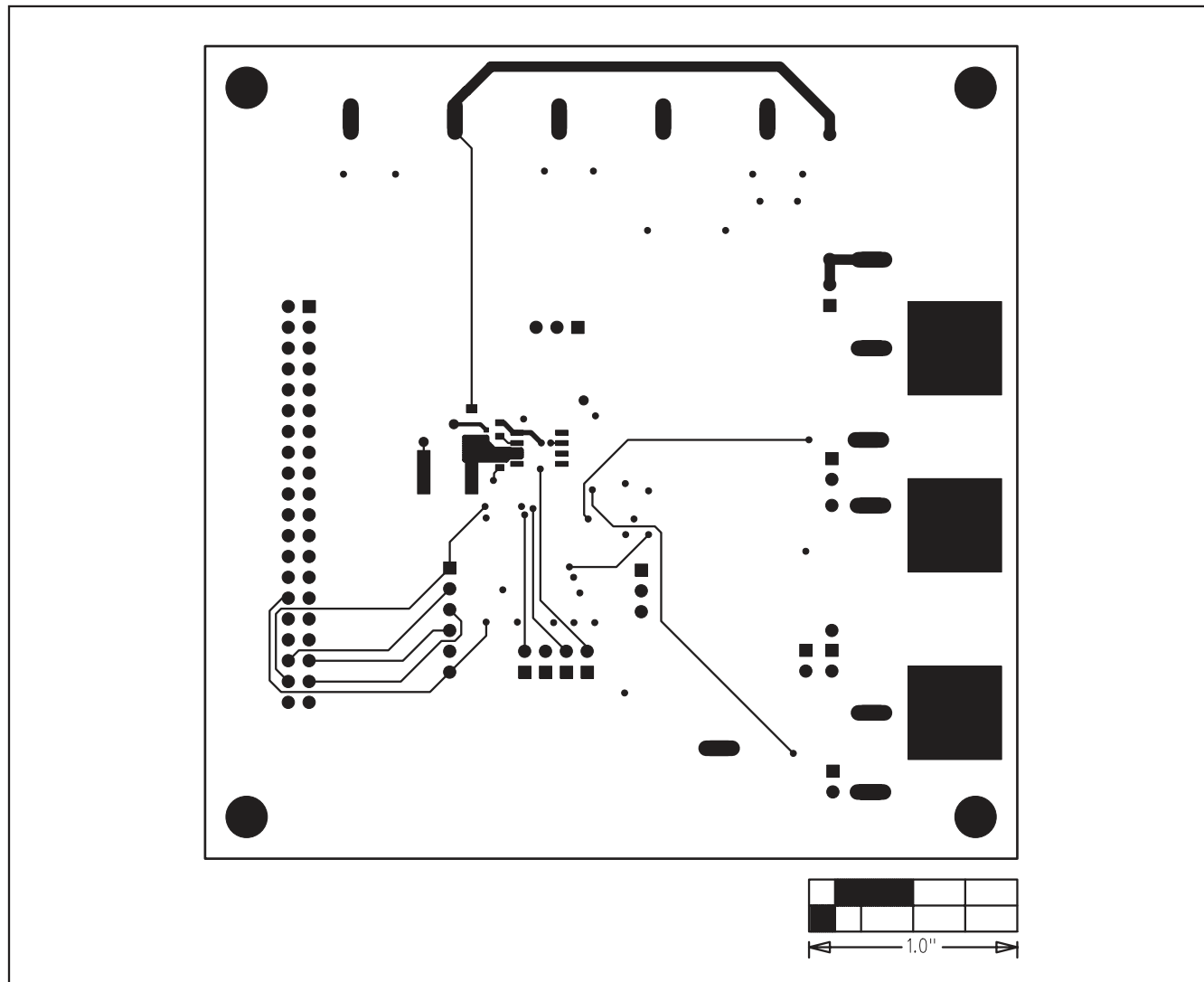

Figure 8. MAX5661 EV Kit PCB Layout—Solder Side

MAX5661 Evaluation Kit/Evaluation System

Evaluate: MAX5661

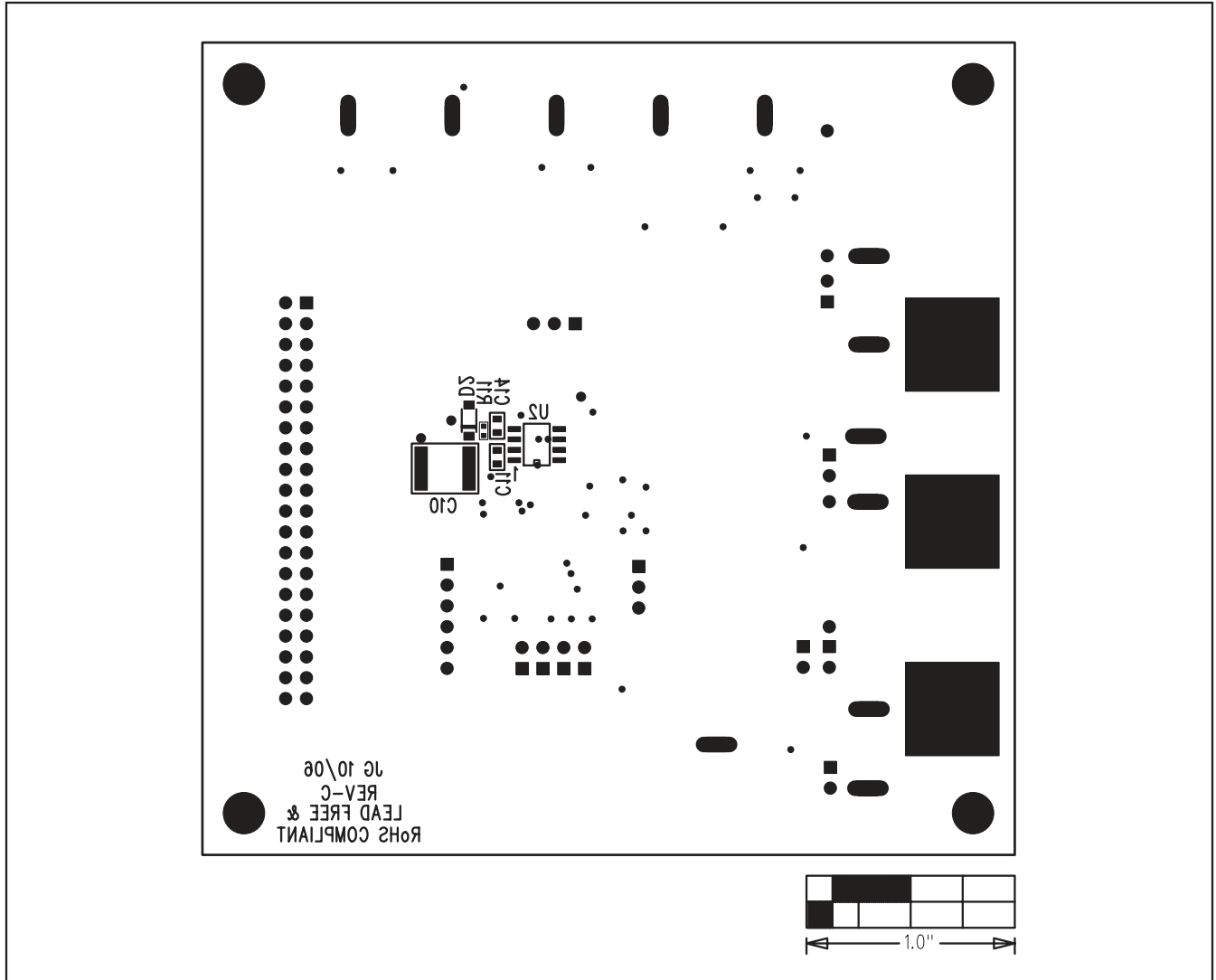

Figure 9. MAX5661 EV Kit Component Placement Guide—Solder Side

Maxim cannot assume responsibility for use of any circuitry other than circuitry entirely embodied in a Maxim product. No circuit patent licenses are implied. Maxim reserves the right to change the circuitry and specifications without notice at any time.

Maxim Integrated Products, 120 San Gabriel Drive, Sunnyvale, CA 94086 408-737-7600 13