

Order Code	TCK-089
Inductance	33 μ H \pm 20% (at 1 kHz / 1 V)
Impedance (DCR)	230 m Ω max.
Rated Current	0.88 A max.
Operating Temperature	-40°C to +125°C
RoHS Exemptions	No Exemptions

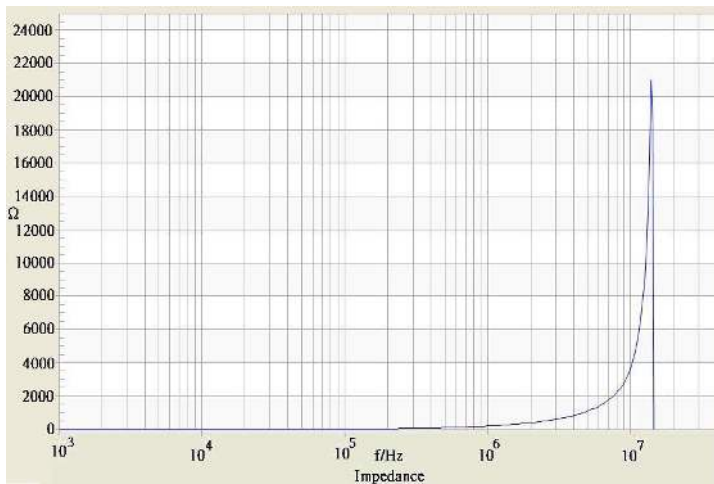

Impedance Curve



Outline Dimensions

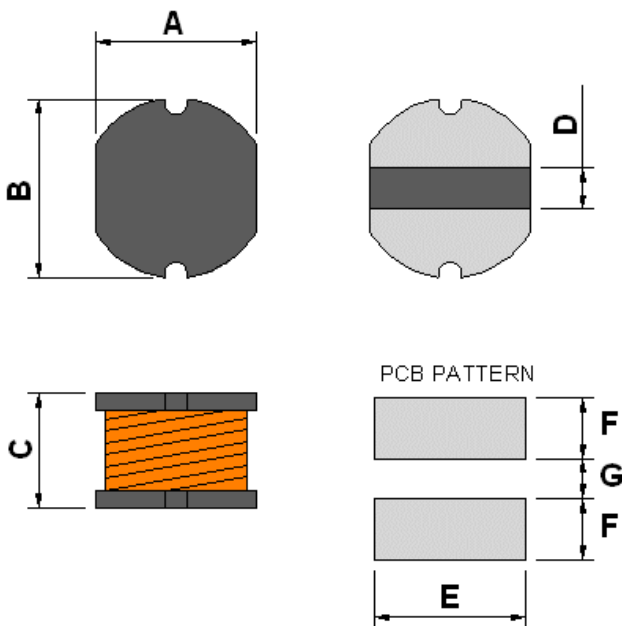

Dimensions [mm]	
A	5.2 \pm 0.5
B	5.8 \pm 0.5
C	4.5 \pm 0.55
D	1.3 typ.
E	5.5
F	2.15
G	1.7

All specifications valid at +25°C, unless otherwise stated.