

APPROVED: \_\_\_\_\_  
 DATE: \_\_\_\_\_ TITLE: \_\_\_\_\_

Rev	AWO #	Description	Date	Appr
-		RELEASED	2/23/16	

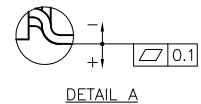

Note:  
 0.4mm compression  
 required to fully  
 seat O-Ring

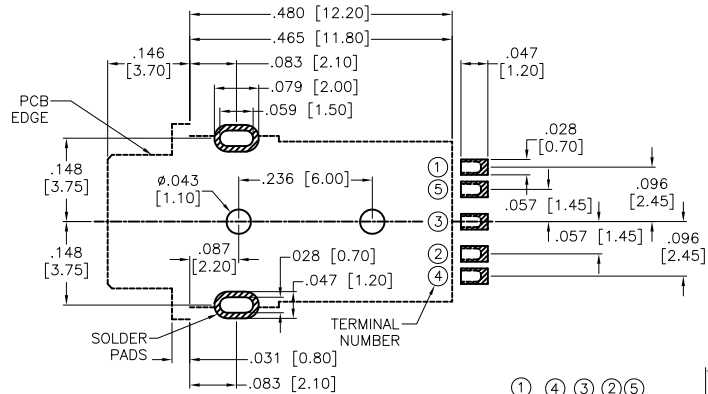
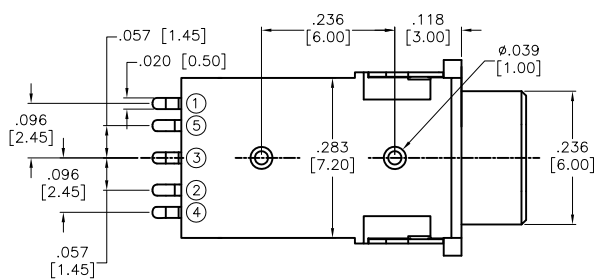
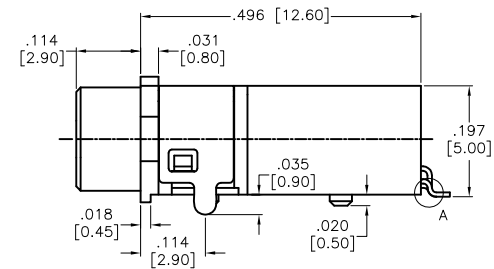
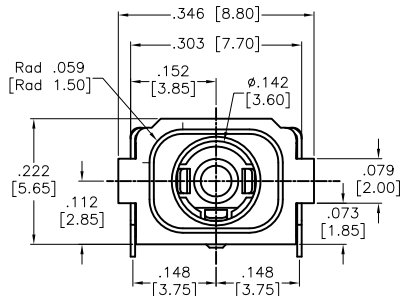
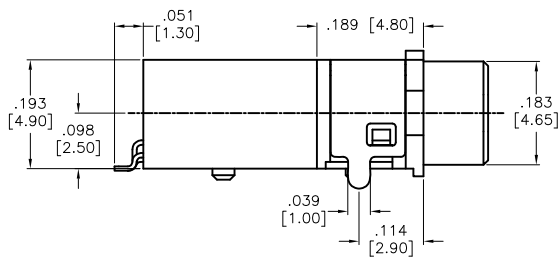
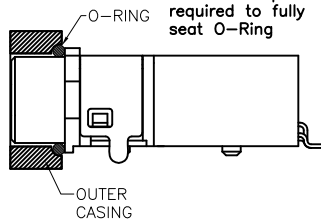

RECOMMENDED PCB LAYOUT

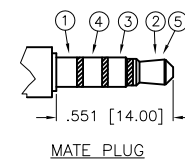
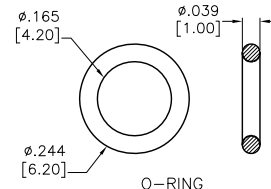

MATE PLUG

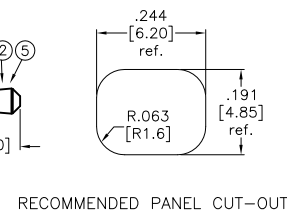

RECOMMENDED PANEL CUT-OUT

SPECIFICATIONS:

Material:  
 Insulator: Hi-Temp Thermoplastic, Rated UL94V-0  
 Insulator Color: Black  
 Contacts: Copper Alloy  
 Shield: Brass, Nickel plated  
 O-Ring: Silicone, 94V-0  
 Plating:  
 Gold Flash over Nickel underplate overall  
 Electrical:  
 Rating: 12 VDC, 1A max.  
 Contact Resistance: 50 mohm Max intinal  
 Insulation Resistane: 100 Mohm Min @ 500 VDC  
 Dielectric Withstanding Voltage: 500 VRMS For 1 Minute.  
 Temperature Rating:  
 Operating temperature: -25°C to +85°C  
 Environmental:  
 Waterproof Rating: IP67  
 Lead free, RoHS compliant.

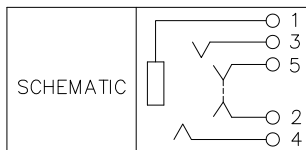

UNLESS OTHERWISE SPECIFIED ALL DIMENSIONS ARE INCHES [MM] TOLERANCES: EXCEPT AS NOTED		
INCHES		HOLES
.X ± .10	∅X ± .10	
.XX ± .020	∅XX ± .015	
.XXX ± .015	∅XXX ± .010	
APPROVALS		DATE
DRAWN	HR	2/23/16
CHECKED	TW	2/23/16
APPROVED		

<b>ADAM TECH</b>		
909 Rahway Avenue, Union, NJ 07083 Phone: 908-687-5000 Fax: 908-687-5710		
TITLE <b>3.5MM WATERPROOF STEREO JACK</b> <b>WATERPROOF RATE: IP67</b>		
SIZE <b>X</b>	PART NO. <b>ASJ-181-1A-HDW-WP</b>	REV. -
REF: S00021C	SCALE: NTS	SHEET 1 OF 1