

- Low Voltage Operation . . . 2.5 V to 7 V
- Low Power . . . 3.5 mA  
(f = 500 kHz, Duty = 50%)
- Internal Undervoltage Lockout Protection
- Internal Short Circuit Protection
- Wide Operating Frequency . . . 50 kHz to 1 MHz
- Internal Precision Reference . . . 1.25 V ±1% (25°C)
- On/Off Switch for CH1/3 Pair and Ch2 (see Function Table)
- 0 to 100% Dead Time Control
- Totem Pole Output Stage
- Small Package . . . 16 Pin TSSOP

PW PACKAGE  
(TOP VIEW)

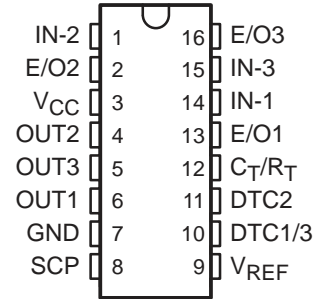

## description

The TPS5100 is a triple PWM control circuit, primarily designed to compose the power supply for LCD display. Each PWM channel has own error amplifier, PWM comparator, dead-time control and output driver. The trimmed voltage reference, oscillator, undervoltage lockout and short circuit protection are common for all channels.

This device includes two boost exclusive circuits (ch1,3) and a buck-boost exclusive circuit (ch2). The operating frequency is set with external resistor and capacitor, and dead time is continuously adjustable from 0% to 100% duty cycle with resistive divider network. Soft start function can be implemented by adding a capacitor to dead time divider network. Two dead time control inputs are assigned for ch1,3 pair and ch2 individually and each dead time control input can be used to control on/off operation. TPS5100 can operate from 2.5 V supply voltage and ch1,3 pair and ch2 operate with reverse phase switching each other to achieve efficient operation in low power and battery powered system.

The TPS5100 is characterized for operation from -20°C to 85°C.

FUNCTION TABLE

CONDITION	OUTPUT		
	CH-1	CH-2	CH-3
DTC1/3 > 0.3 V, DTC2 > 0.3 V	ON H	ON L	ON H
DTC1/3 > 0.3 V, DTC2 < 0.2 V	ON H	OFF H	ON H
DTC1/3 < 0.2 V, DTC2 > 0.3 V	OFF L	ON L	OFF L
DTC1/3 < 0.2 V, DTC2 < 0.2 V	OFF L	OFF H	OFF L

AVAILABLE OPTIONS

T <sub>A</sub>	PACKAGE
	TSSOP (PW)
-20°C to 85°C	TPS5100PW



Please be aware that an important notice concerning availability, standard warranty, and use in critical applications of Texas Instruments semiconductor products and disclaimers thereto appears at the end of this data sheet.

# TPS5100 TRIPLE-CHANNEL PWM CONTROL CIRCUITS

SLVS169 – JANUARY 2000

## functional block diagram

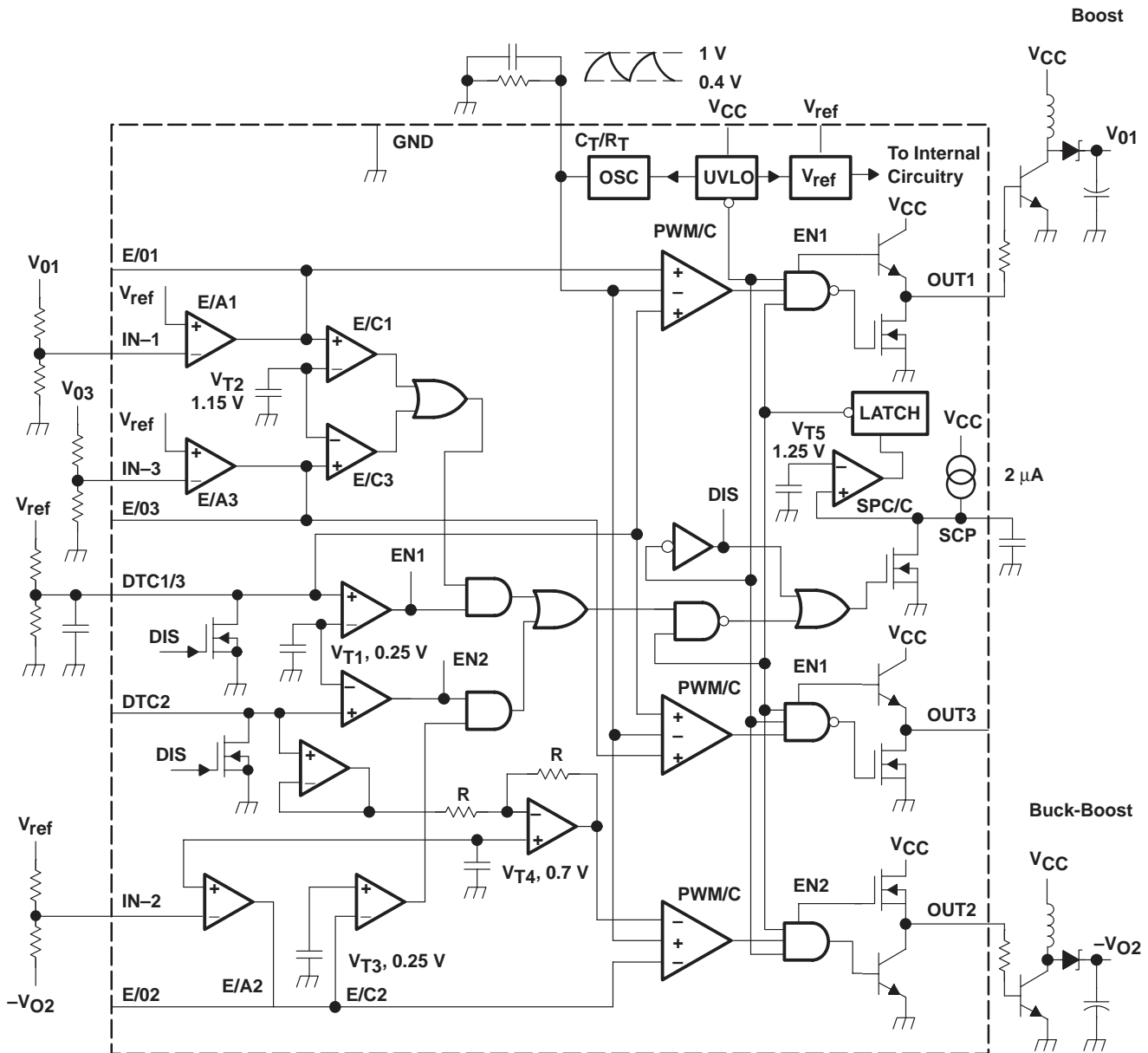

NOTE A: All voltages and currents listed are nominal.

**electrical characteristics over recommended operating free-air temperature range,  $V_{CC} = 3.3\text{ V}$  (unless otherwise noted) (see Note 1)**

PARAMETER		TEST CONDITIONS	MIN	TYP	MAX	UNIT
$V_{REF}$	Reference voltage	$I_{REF} = -1\text{ mA}$ , $T_A = 25^\circ\text{C}$	1.237	1.250	1.263	V
$V_{REF(dev)}$	Reference voltage change with $T_A$	$I_{REF} = -1\text{ mA}$ , See Note 2		15	25	mV
REGIN	Input regulation	$I_{REF} = -1\text{ mA}$ , $V_{CC} = 2.5\text{ V to }7\text{ V}$		2	5	mV
REGL	Output regulation	$I_{REF} = -0.1\text{ mA to }-1\text{ mA}$		1	5	mV
$I_{OS}$	Short-circuit output current	$V_{REF} = 0$	-2	-10	-30	mA

NOTES: 1. Typical values of all parameters except for  $V_{REF(dev)}$  and  $f_{dT}$  are specified at  $T_A = 25^\circ\text{C}$ .  
2. The deviation parameter  $V_{REF(dev)}$  is defined as the difference between the maximum and minimum values obtained over the recommended free-air temperature range ( $-20^\circ\text{C}$  to  $85^\circ\text{C}$ ).

### undervoltage lockout section

PARAMETER		TEST CONDITIONS	MIN	TYP	MAX	UNIT
$V_{TH}$	Upper threshold voltage	$T_A = 25^\circ\text{C}$	2.2	2.3	2.4	V
$V_{TL}$	Lower threshold voltage	$T_A = 25^\circ\text{C}$	2	2.1	2.2	V
$V_{hys}$	Hysteresis ( $V_{TH} - V_{TL}$ )	$T_A = 25^\circ\text{C}$	0.1	0.2	0.3	V

NOTE 1: Typical values of all parameters except for  $V_{REF(dev)}$  and  $f_{dT}$  are specified at  $T_A = 25^\circ\text{C}$ .

### protection control section

PARAMETER		TEST CONDITIONS	MIN	TYP	MAX	UNIT
$I_{SCP}$	Input terminal source current		-1.4	-2	-2.6	$\mu\text{A}$
$V_{T2}$	Input threshold voltage	CH-1, 3	1.10	1.15	1.20	V
$V_{T3}$		CH-2	0.20	0.25	0.30	
$V_R$	Latch reset threshold voltage	$T_A = 25^\circ\text{C}$	0.8	1.5		V
$V_{T5}$	Threshold voltage		1.20	1.25	1.30	V

NOTE 1: Typical values of all parameters except for  $V_{REF(dev)}$  and  $f_{dT}$  are specified at  $T_A = 25^\circ\text{C}$ .

### oscillator section

PARAMETER		TEST CONDITIONS	MIN	TYP	MAX	UNIT
$f_{OSC}$	Frequency	$C_T = 130\text{ pF}$ , $R_T = 7\text{ k}\Omega$	400	500	600	kHz
$f_{dV}$	Frequency change with $V_{CC}$	$V_{CC} = 2.5\text{ V}$ , $T_A = 25^\circ\text{C}$ , $C_T = 130\text{ pF}$ , $R_T = 7\text{ k}\Omega$		1%	2%	
$f_{dT}$	Frequency change with $T_A$	$C_T = 130\text{ pF}$ , $R_T = 7\text{ k}\Omega$		5%	10%	
$I_{CT/RT}$	Output source current		-180	-200	-220	$\mu\text{A}$
$V_{OSCH}$	H level output voltage		0.95	1	1.05	V
$V_{OSCL}$	L level output voltage		0.35	0.40	0.45	V

NOTE 1: Typical values of all parameters except for  $V_{REF(dev)}$  and  $f_{dT}$  are specified at  $T_A = 25^\circ\text{C}$ .

### dead time control section

PARAMETER		TEST CONDITIONS	MIN	TYP	MAX	UNIT
$I_{BDT1/3}$	Input bias current	$V_{DTC1/3} = 0.35\text{ V to }1.05\text{ V}$			200	nA
$I_{BDT2}$		$V_{DTC2} = 0.35\text{ V to }1.05\text{ V}$		$\pm 2$	$\pm 20$	
$V_{T1}$	Comparator threshold voltage		0.2	0.25	0.3	V
$V_{T0(DTC1/3)}$	Input threshold voltage (DTC1/3) (see Note 3)	Duty = 0%	0.3	0.4	0.5	V
$V_{T100(DTC1/3)}$		Duty = 100%				
$V_{T0(DTC2)}$	Input threshold voltage (DTC2) (see Note 3)	Duty = 0%	0.3	0.4	0.5	V
$V_{T100(DTC2)}$		Duty = 100%				

NOTES: 1. Typical values of all parameters except for  $V_{REF(dev)}$  and  $f_{dT}$  are specified at  $T_A = 25^\circ\text{C}$ .  
3. These specifications are not production tested. They are specified as ensured values on circuit design.

# TPS5100

## TRIPLE-CHANNEL PWM CONTROL CIRCUITS

SLVS169 – JANUARY 2000

electrical characteristics over recommended operating free-air temperature range,  $V_{CC} = 3.3\text{ V}$  (unless otherwise noted) (see Note 1) (continued)

### error amplifier section

PARAMETER		TEST CONDITIONS		MIN	TYP	MAX	UNIT
$V_{IO}$	Input offset voltage	CH1, 3,	$A_V = 1$			15	mV
$I_{IB}$	Input bias current	CH1, 3,	$V_I = -.95\text{ V to }1.55\text{ V}$		$\pm 10$	$\pm 20$	nA
		CH2,	$V_I = 0.4\text{ V to }1\text{ V}$		$\pm 10$	$\pm 20$	
$V_{IR}$	Input voltage range	CH1, 3,		0.95		1.55	V
		CH2		0.4		1	
$A_{VD}$	Open-loop voltage amplification	$R_{FB} = 200\text{ k}\Omega$			60		dB
$B_1$	Unity-gain bandwidth				1		MHz
$V_{OM+}$	Output voltage swing	$V_{ID} = 0.1\text{ V}$	$I_O = 60\text{ }\mu\text{A}$	1.2			V
$V_{OM-}$			$I_O = 0.2\text{ mA}$	0.2			
$I_{OM+}$	Output sink current	$V_{ID} = 0.1\text{ V},$	$V_O = 0.2\text{ V}$	0.2	1		mA
$I_{OM-}$	Output source current	$V_{ID} = 0.1\text{ V},$	$V_O = 1.2\text{ V}$	-60	-100		$\mu\text{A}$
$V_{T4}$	Input bias voltage	CH2,	$A_V = 1, T_A = 25^\circ\text{C}$	678	700	722	mV
		CH2,	$A_V = 1$	665	700	735	

NOTE 1: Typical values of all parameters except for  $V_{REF(dev)}$  and  $f_{dT}$  are specified at  $T_A = 25^\circ\text{C}$ .

### output section

PARAMETER		TEST CONDITIONS		MIN	TYP	MAX	UNIT
$V_{OH}$	High-level output voltage	$I_O = 20\text{ mA (CH2)}$		2.9	3.05		V
		$I_O = -40\text{ mA (CH1, 3)}$		1.9	2.2	2.6	
$V_{OL}$	Low-level output voltage	$I_O = 20\text{ mA (CH1, 3)}$			0.2	0.4	V
		$I_O = 40\text{ mA (CH2)}$		0.2	0.3	0.6	
$t_r$	Rise time	$CL = 1000\text{ pF}$			130		ns
$t_f$	Fall time	$I_O = 1000\text{ pF}$			50		ns

NOTE 1: Typical values of all parameters except for  $V_{REF(dev)}$  and  $f_{dT}$  are specified at  $T_A = 25^\circ\text{C}$ .

### total device

PARAMETER		TEST CONDITIONS		MIN	TYP	MAX	UNIT
$I_{CC}$	Supply current	Output OFF state			2.5	4	mA
$I_{CCA}$	Average supply current	$F_{OSC} = 500\text{ kHz, Duty} = 50\%, \text{ No load}$			3.5	5	mA

NOTE 1: Typical values of all parameters except for  $V_{REF(dev)}$  and  $f_{dT}$  are specified at  $T_A = 25^\circ\text{C}$ .



TYPICAL CHARACTERISTICS

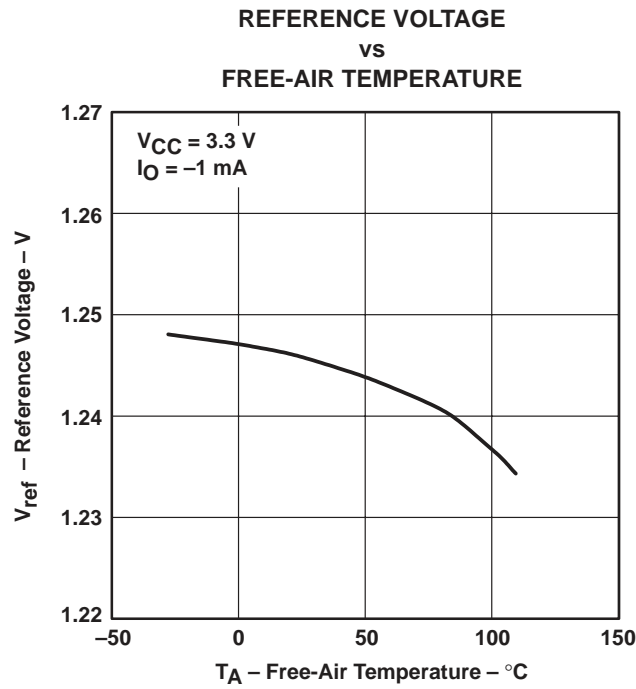

Figure 1

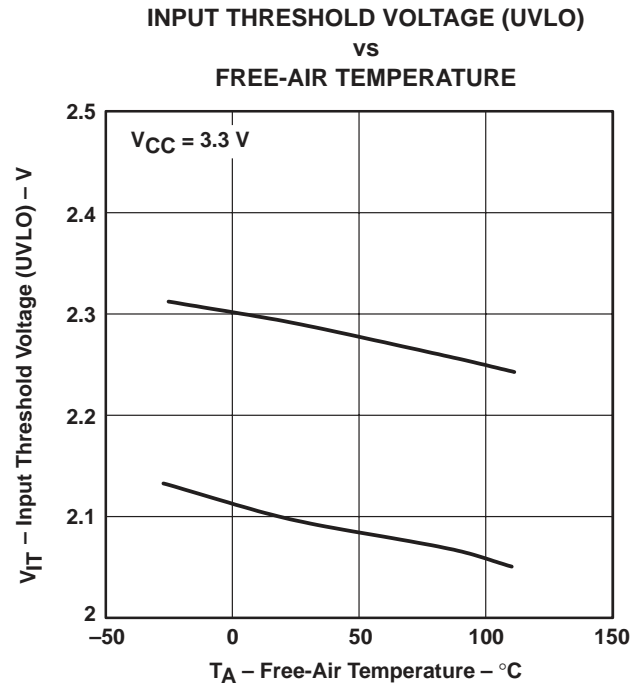

Figure 2

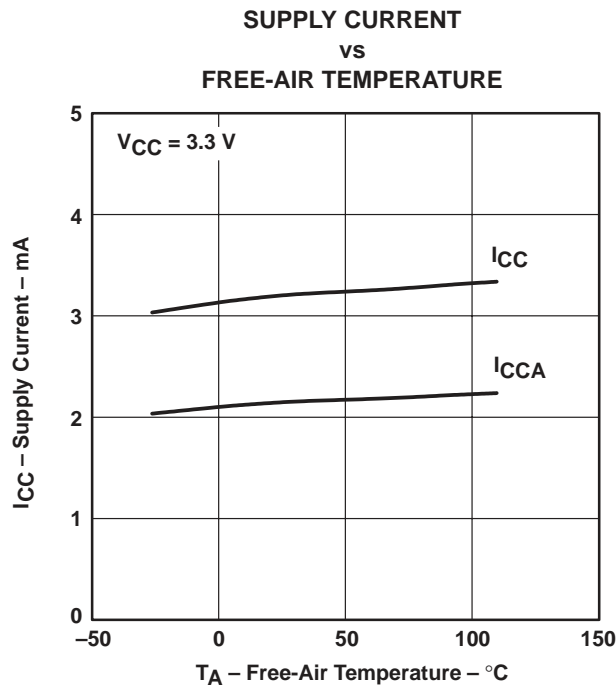

Figure 3

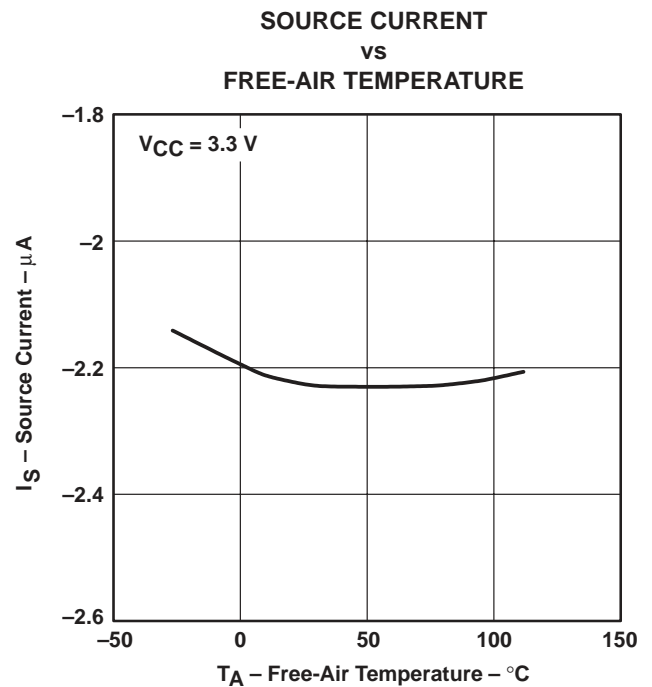

Figure 4

TYPICAL CHARACTERISTICS

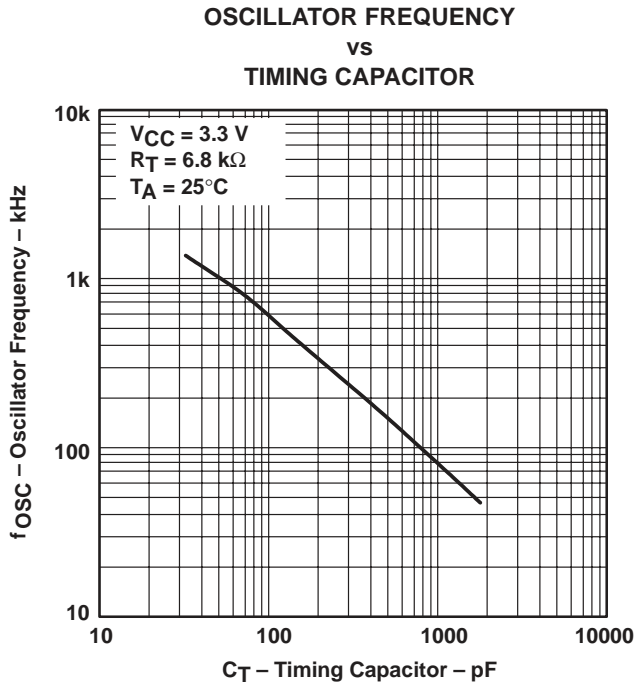

Figure 5

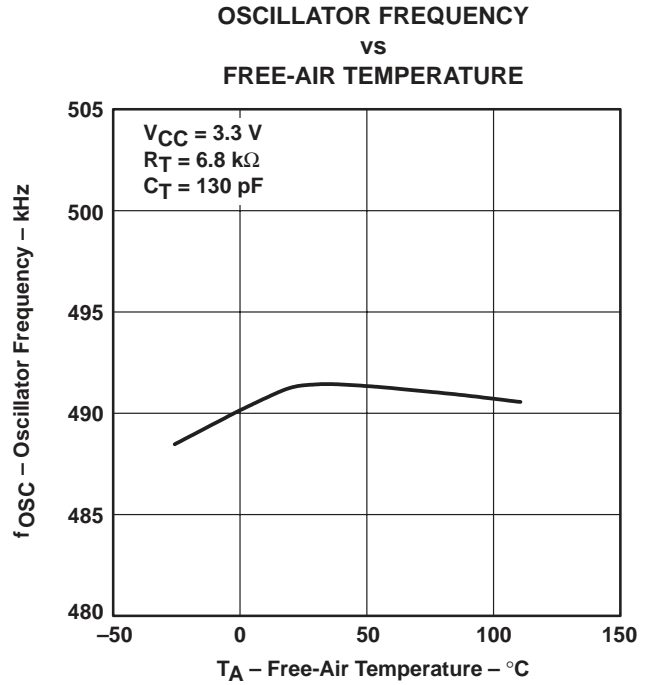

Figure 6

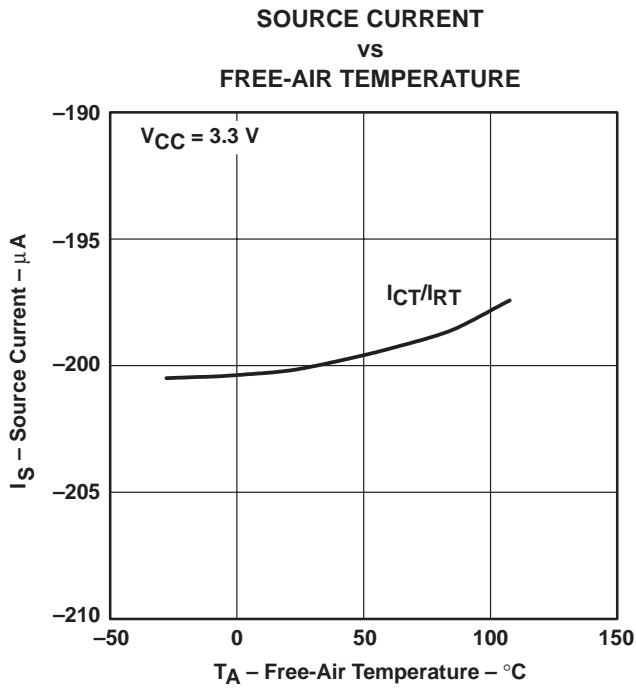
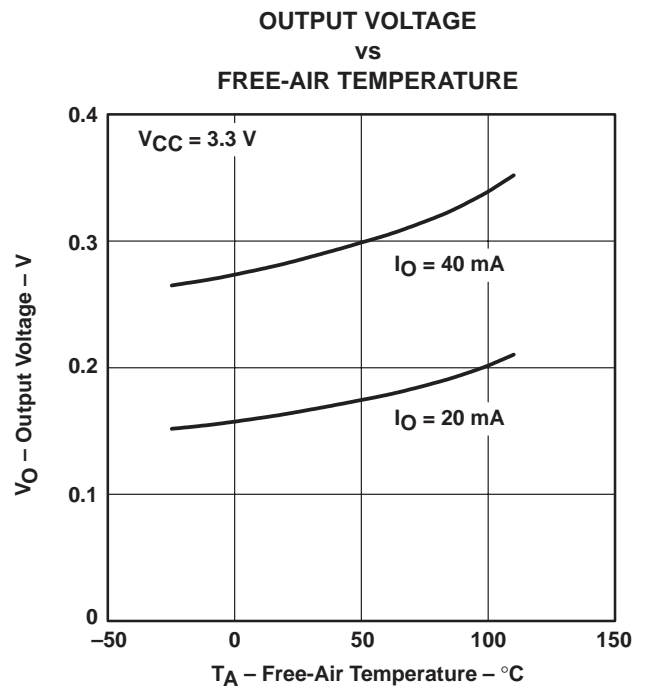
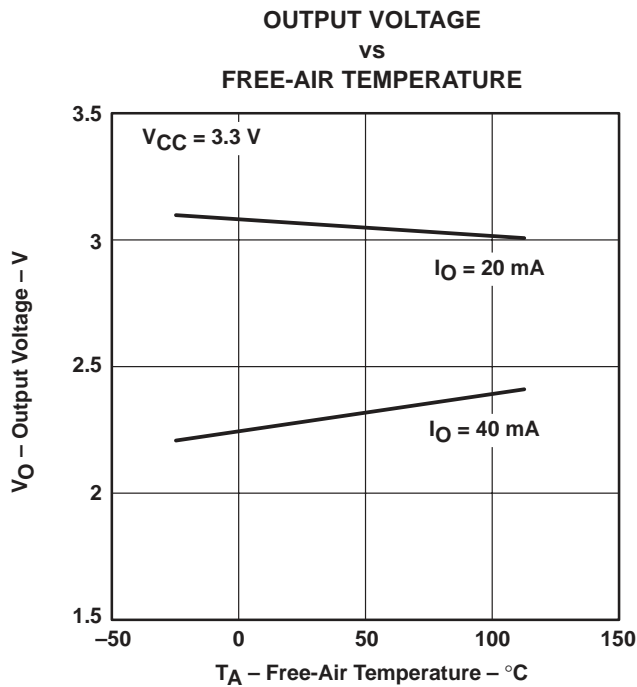
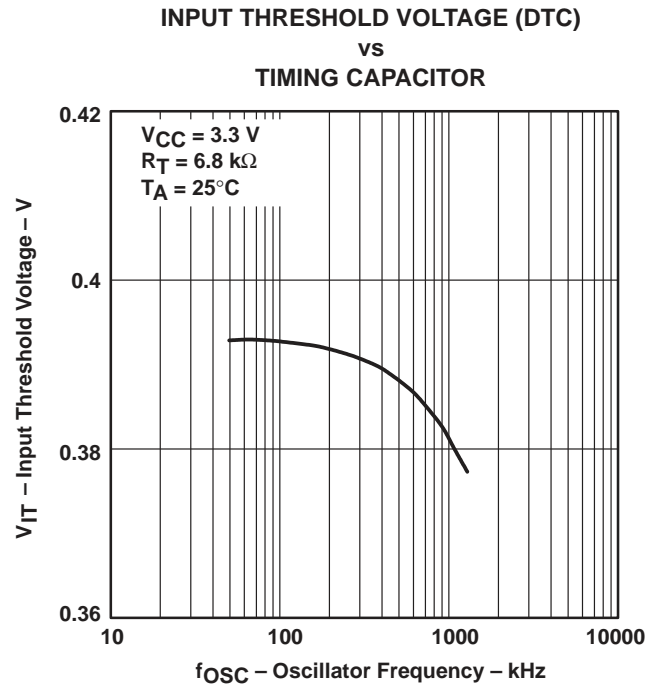
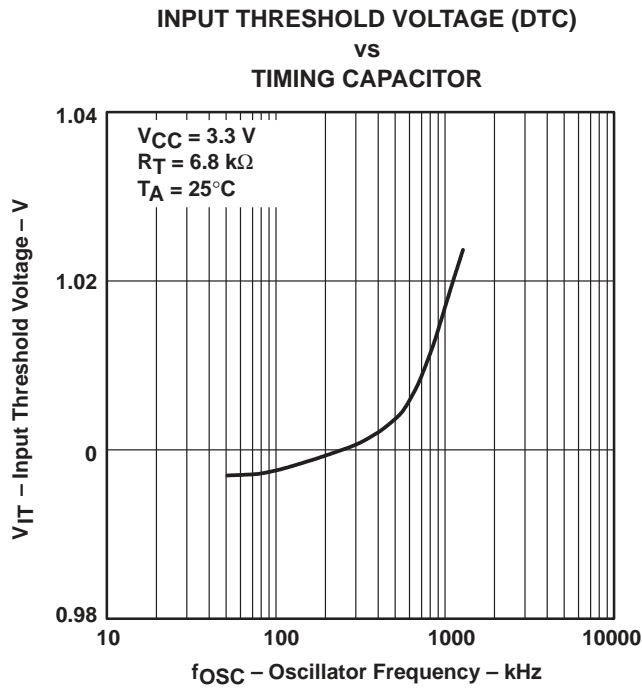
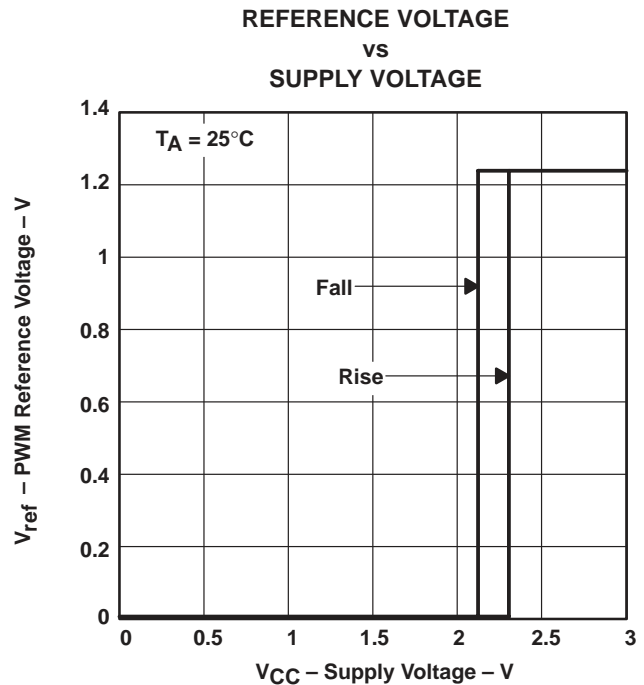
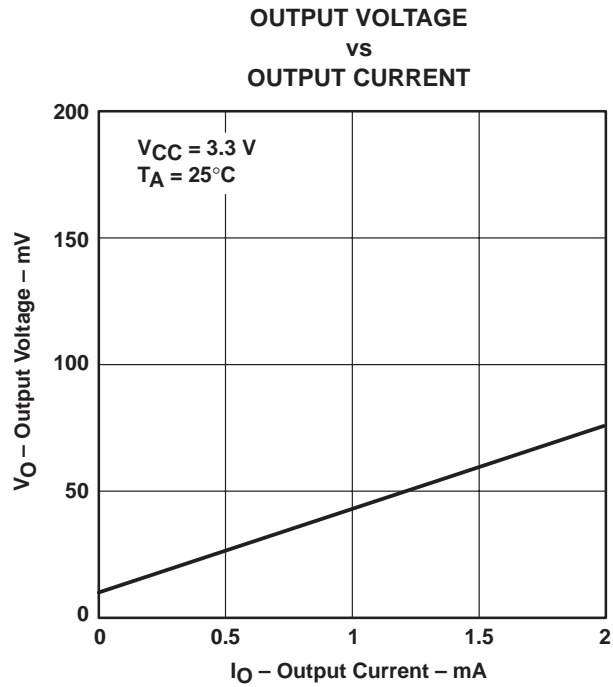
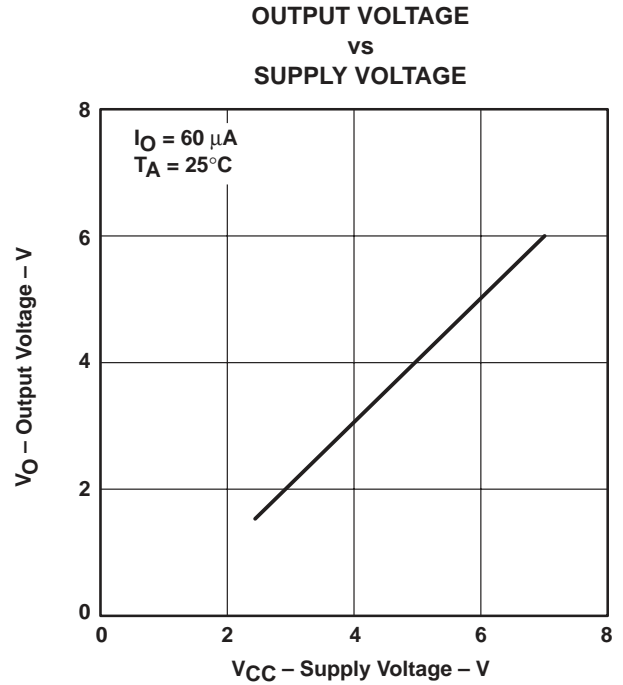
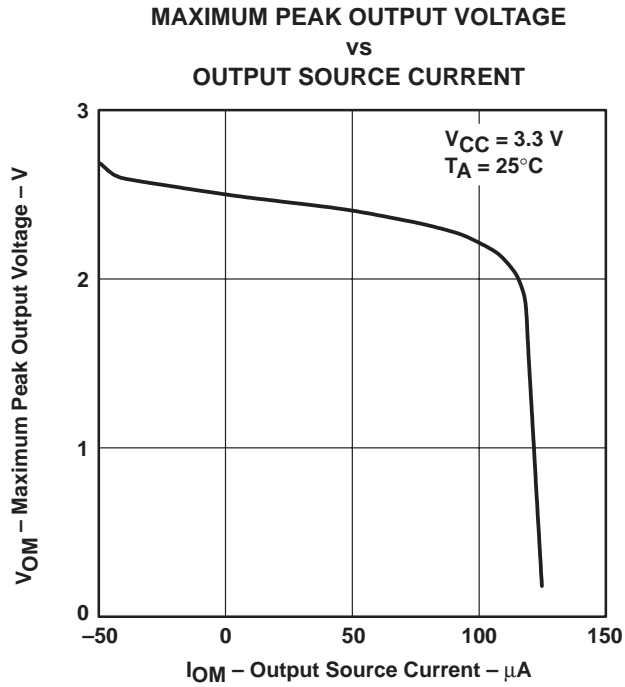

Figure 7

TYPICAL CHARACTERISTICS



TYPICAL CHARACTERISTICS





TYPICAL CHARACTERISTICS

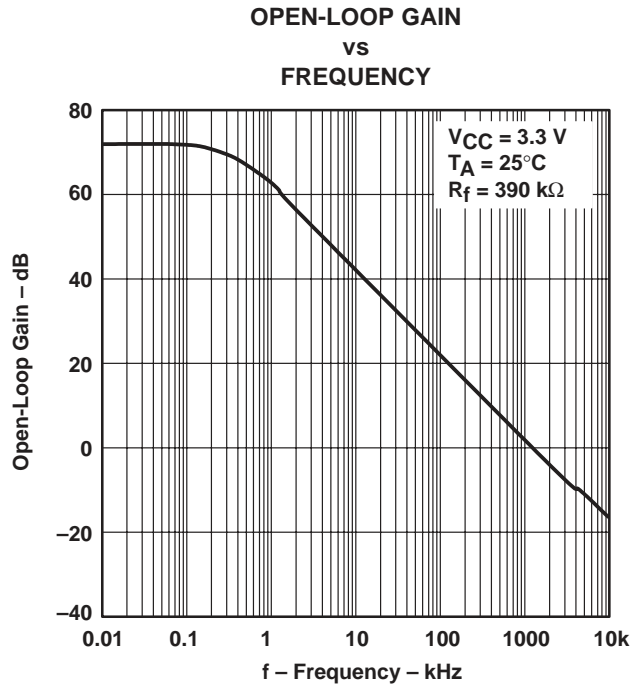

Figure 16

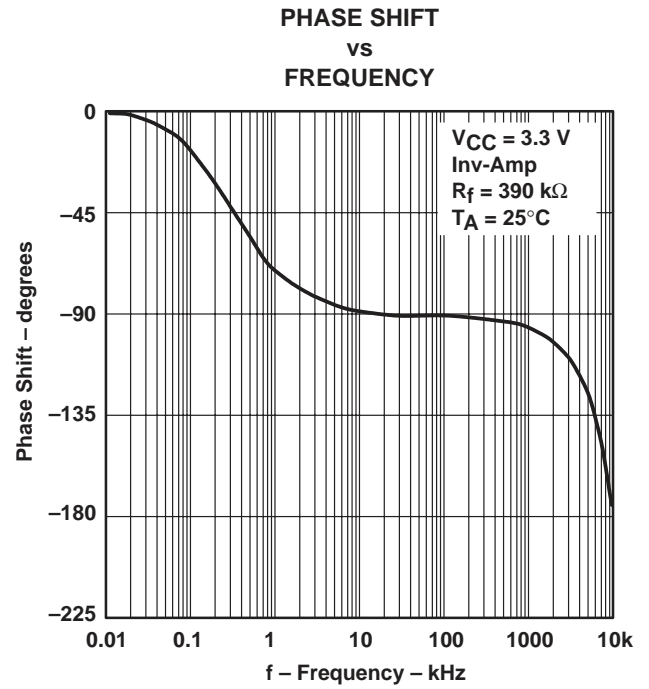

Figure 17

**PACKAGING INFORMATION**

Orderable Device	Status (1)	Package Type	Package Drawing	Pins	Package Qty	Eco Plan (2)	Lead finish/ Ball material (6)	MSL Peak Temp (3)	Op Temp (°C)	Device Marking (4/5)	Samples
TPS51001PW	ACTIVE	TSSOP	PW	16	90	RoHS & Green	NIPDAU	Level-1-260C-UNLIM	-40 to 85	PU5100	Samples

(1) The marketing status values are defined as follows:

**ACTIVE:** Product device recommended for new designs.

**LIFEBUY:** TI has announced that the device will be discontinued, and a lifetime-buy period is in effect.

**NRND:** Not recommended for new designs. Device is in production to support existing customers, but TI does not recommend using this part in a new design.

**PREVIEW:** Device has been announced but is not in production. Samples may or may not be available.

**OBSOLETE:** TI has discontinued the production of the device.

(2) **RoHS:** TI defines "RoHS" to mean semiconductor products that are compliant with the current EU RoHS requirements for all 10 RoHS substances, including the requirement that RoHS substance do not exceed 0.1% by weight in homogeneous materials. Where designed to be soldered at high temperatures, "RoHS" products are suitable for use in specified lead-free processes. TI may reference these types of products as "Pb-Free".

**RoHS Exempt:** TI defines "RoHS Exempt" to mean products that contain lead but are compliant with EU RoHS pursuant to a specific EU RoHS exemption.

**Green:** TI defines "Green" to mean the content of Chlorine (Cl) and Bromine (Br) based flame retardants meet JS709B low halogen requirements of <=1000ppm threshold. Antimony trioxide based flame retardants must also meet the <=1000ppm threshold requirement.

(3) MSL, Peak Temp. - The Moisture Sensitivity Level rating according to the JEDEC industry standard classifications, and peak solder temperature.

(4) There may be additional marking, which relates to the logo, the lot trace code information, or the environmental category on the device.

(5) Multiple Device Markings will be inside parentheses. Only one Device Marking contained in parentheses and separated by a "-" will appear on a device. If a line is indented then it is a continuation of the previous line and the two combined represent the entire Device Marking for that device.

(6) Lead finish/Ball material - Orderable Devices may have multiple material finish options. Finish options are separated by a vertical ruled line. Lead finish/Ball material values may wrap to two lines if the finish value exceeds the maximum column width.

**Important Information and Disclaimer:** The information provided on this page represents TI's knowledge and belief as of the date that it is provided. TI bases its knowledge and belief on information provided by third parties, and makes no representation or warranty as to the accuracy of such information. Efforts are underway to better integrate information from third parties. TI has taken and continues to take reasonable steps to provide representative and accurate information but may not have conducted destructive testing or chemical analysis on incoming materials and chemicals. TI and TI suppliers consider certain information to be proprietary, and thus CAS numbers and other limited information may not be available for release.

In no event shall TI's liability arising out of such information exceed the total purchase price of the TI part(s) at issue in this document sold by TI to Customer on an annual basis.

**TUBE**

\*All dimensions are nominal

Device	Package Name	Package Type	Pins	SPQ	L (mm)	W (mm)	T (μm)	B (mm)
TPS5100IPW	PW	TSSOP	16	90	530	10.2	3600	3.5

# PW0016A



# PACKAGE OUTLINE

## TSSOP - 1.2 mm max height

SMALL OUTLINE PACKAGE



### NOTES:

1. All linear dimensions are in millimeters. Any dimensions in parenthesis are for reference only. Dimensioning and tolerancing per ASME Y14.5M.
2. This drawing is subject to change without notice.
3. This dimension does not include mold flash, protrusions, or gate burrs. Mold flash, protrusions, or gate burrs shall not exceed 0.15 mm per side.
4. This dimension does not include interlead flash. Interlead flash shall not exceed 0.25 mm per side.
5. Reference JEDEC registration MO-153.

# EXAMPLE BOARD LAYOUT

PW0016A

TSSOP - 1.2 mm max height

SMALL OUTLINE PACKAGE



LAND PATTERN EXAMPLE  
EXPOSED METAL SHOWN  
SCALE: 10X



SOLDER MASK DETAILS

4220204/A 02/2017

NOTES: (continued)

- 6. Publication IPC-7351 may have alternate designs.
- 7. Solder mask tolerances between and around signal pads can vary based on board fabrication site.

# EXAMPLE STENCIL DESIGN

PW0016A

TSSOP - 1.2 mm max height

SMALL OUTLINE PACKAGE

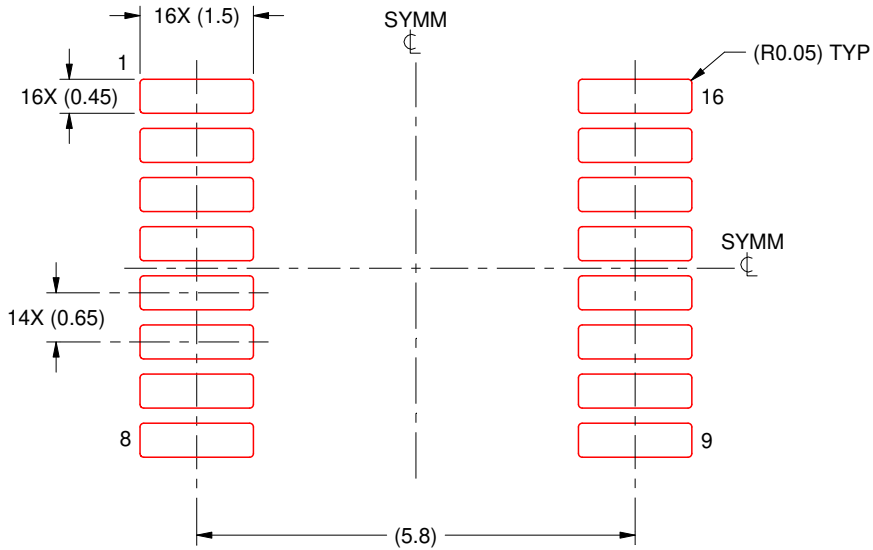

SOLDER PASTE EXAMPLE  
BASED ON 0.125 mm THICK STENCIL  
SCALE: 10X

4220204/A 02/2017

NOTES: (continued)

8. Laser cutting apertures with trapezoidal walls and rounded corners may offer better paste release. IPC-7525 may have alternate design recommendations.
9. Board assembly site may have different recommendations for stencil design.

## IMPORTANT NOTICE AND DISCLAIMER

TI PROVIDES TECHNICAL AND RELIABILITY DATA (INCLUDING DATA SHEETS), DESIGN RESOURCES (INCLUDING REFERENCE DESIGNS), APPLICATION OR OTHER DESIGN ADVICE, WEB TOOLS, SAFETY INFORMATION, AND OTHER RESOURCES "AS IS" AND WITH ALL FAULTS, AND DISCLAIMS ALL WARRANTIES, EXPRESS AND IMPLIED, INCLUDING WITHOUT LIMITATION ANY IMPLIED WARRANTIES OF MERCHANTABILITY, FITNESS FOR A PARTICULAR PURPOSE OR NON-INFRINGEMENT OF THIRD PARTY INTELLECTUAL PROPERTY RIGHTS.

These resources are intended for skilled developers designing with TI products. You are solely responsible for (1) selecting the appropriate TI products for your application, (2) designing, validating and testing your application, and (3) ensuring your application meets applicable standards, and any other safety, security, regulatory or other requirements.

These resources are subject to change without notice. TI grants you permission to use these resources only for development of an application that uses the TI products described in the resource. Other reproduction and display of these resources is prohibited. No license is granted to any other TI intellectual property right or to any third party intellectual property right. TI disclaims responsibility for, and you will fully indemnify TI and its representatives against, any claims, damages, costs, losses, and liabilities arising out of your use of these resources.

TI's products are provided subject to [TI's Terms of Sale](#) or other applicable terms available either on [ti.com](#) or provided in conjunction with such TI products. TI's provision of these resources does not expand or otherwise alter TI's applicable warranties or warranty disclaimers for TI products.

TI objects to and rejects any additional or different terms you may have proposed.

Mailing Address: Texas Instruments, Post Office Box 655303, Dallas, Texas 75265  
Copyright © 2022, Texas Instruments Incorporated