

TINA2-RS

~14° spot beam optimized for Osram Golden Dragon+. Assembly with holder and installation tape.

SPECIFICATION:

Dimensions	Ø 16.1 mm
Height	10.1 mm
Fastening	tape
ROHS compliant	yes ⓘ



MATERIALS:

Component	Type	Material	Colour	Finish
TINA2-O-PLUS-RS	Single lens	PMMA	clear	
TINA2-O-PLUS-HLD-WHT	Holder	PC	white	
TINA-TAPE3	Tape	Acrylic foam	black	

ORDERING INFORMATION:

Component		Qty in box	MOQ	MPQ	Box weight (kg)
CA11847_TINA2-RS	Single lens	4140	230	230	0.0
» Box size: 451 x 241 x 298 mm					

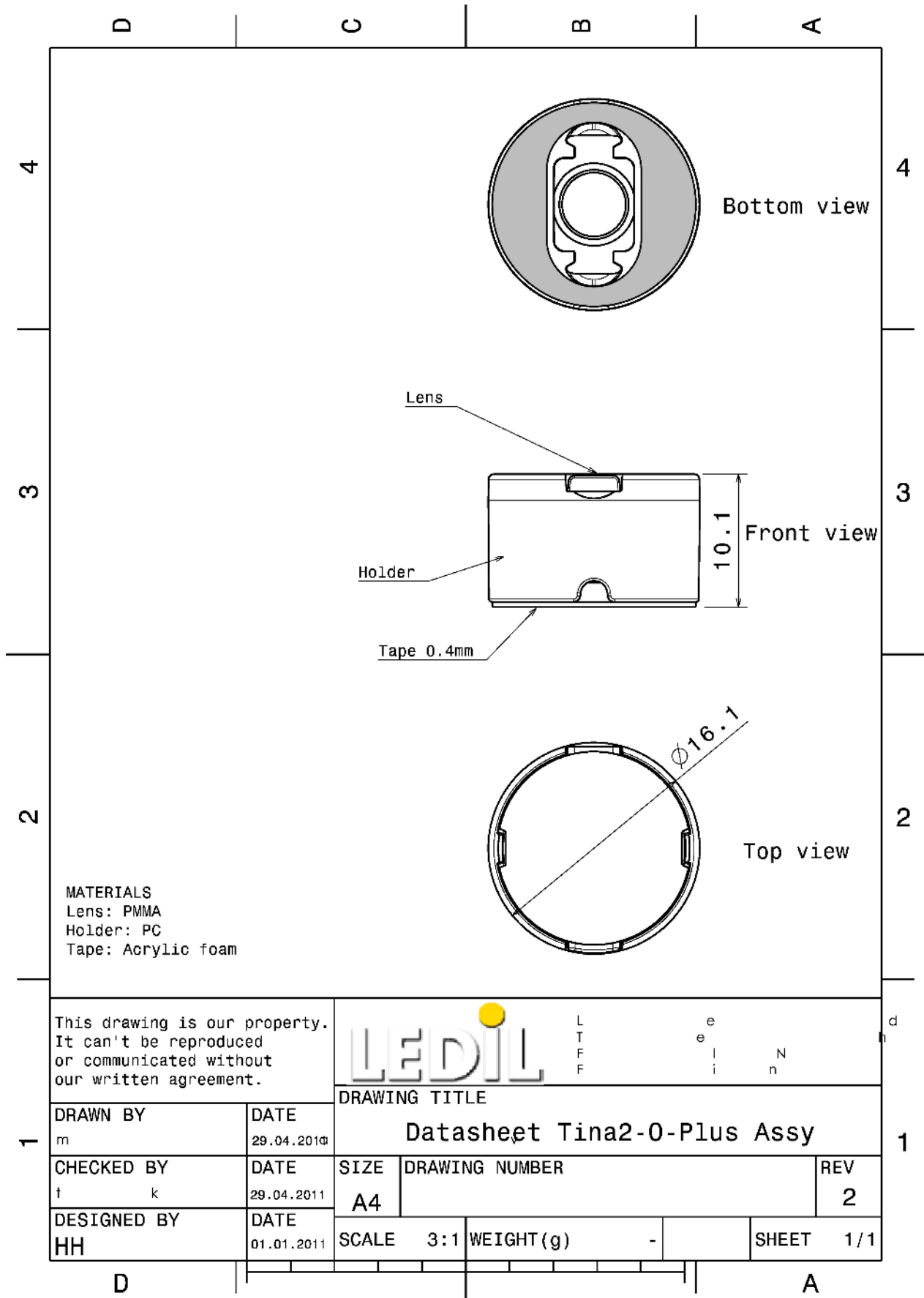

See also our general installation guide: www.ledil.com/installation_guide

OPTICAL RESULTS (MEASURED):

OSRAM
Opto Semiconductors

LED	Golden Dragon+
FWHM / FWTM	10.0° / 20.0°
Efficiency	93 %
Peak intensity	18 cd/lm
LEDs/each optic	1
Light colour	White
Required components:	

OPTICAL RESULTS (SIMULATED):

CREE → LED

LED XP-G2 HE
 FWHM / FWTM 17.0° / 34.0°
 Efficiency 88 %
 Peak intensity 6.8 cd/lm
 LEDs/each optic 1
 Light colour White
 Required components:

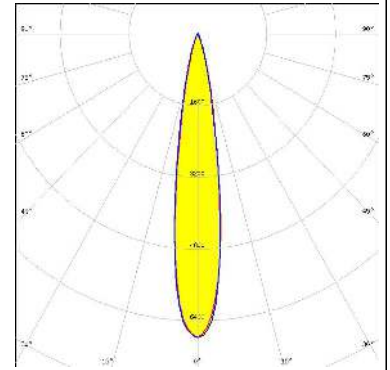

CREE → LED

LED XP-G3
 FWHM / FWTM 16.0° / 34.0°
 Efficiency 85 %
 Peak intensity 6.6 cd/lm
 LEDs/each optic 1
 Light colour White
 Required components:

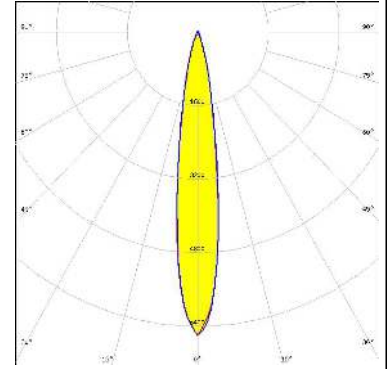

CREE → LED

LED XP-L HI
 FWHM / FWTM 12.0° / 30.0°
 Efficiency 89 %
 Peak intensity 9.6 cd/lm
 LEDs/each optic 1
 Light colour White
 Required components:

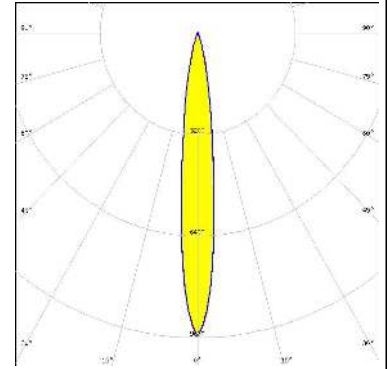

CREE → LED

LED XT-E
 FWHM / FWTM 12.0° / 30.0°
 Efficiency 82 %
 Peak intensity 8 cd/lm
 LEDs/each optic 1
 Light colour White
 Required components:

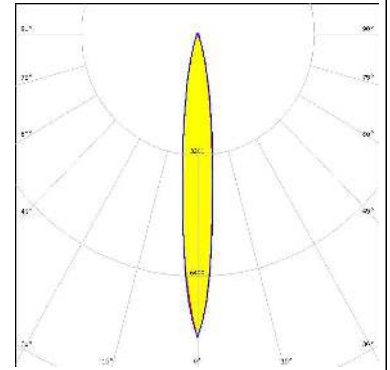

OPTICAL RESULTS (SIMULATED):

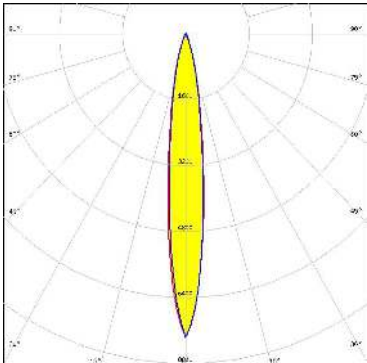
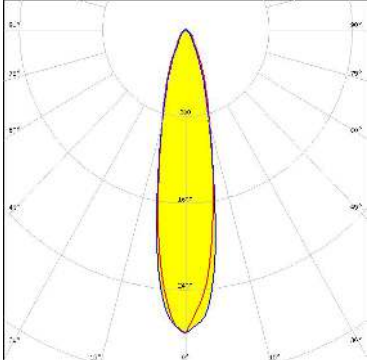
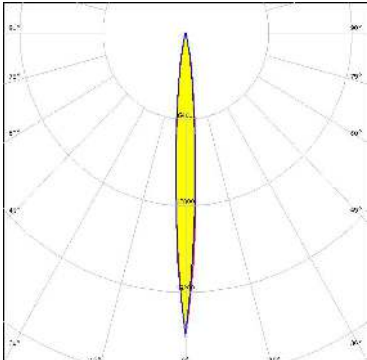
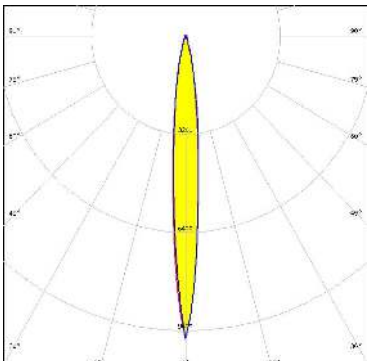
<p>LUMILEDS</p> <p>LED LUXEON 3030 HE Plus</p> <p>FWHM / FWTM 14.0° / 34.0°</p> <p>Efficiency 87 %</p> <p>Peak intensity 7.4 cd/lm</p> <p>LEDs/each optic 1</p> <p>Light colour White</p> <p>Required components:</p>	
<p>LUMILEDS</p> <p>LED LUXEON 5050 Square LES</p> <p>FWHM / FWTM 22.0° / 52.0°</p> <p>Efficiency 85 %</p> <p>Peak intensity 2.8 cd/lm</p> <p>LEDs/each optic 1</p> <p>Light colour White</p> <p>Required components:</p>	
<p>LUMILEDS</p> <p>LED LUXEON CZ</p> <p>FWHM / FWTM 8.0° / 20.0°</p> <p>Efficiency 88 %</p> <p>Peak intensity 22.5 cd/lm</p> <p>LEDs/each optic 1</p> <p>Light colour Red</p> <p>Required components:</p>	
<p>LUMILEDS</p> <p>LED LUXEON IR Domed 150</p> <p>FWHM / FWTM 10.0° / 27.0°</p> <p>Efficiency 81 %</p> <p>LEDs/each optic 1</p> <p>Light colour IR</p> <p>Required components:</p>	

OPTICAL RESULTS (SIMULATED):

<p>NICHIA</p> <p>LED NV4WB35AM FWHM / FWTM 20.0° / 44.0° Efficiency 86 % Peak intensity 3.9 cd/lm LEDs/each optic 1 Light colour White Required components:</p>	
<p>NICHIA</p> <p>LED NVSW219F FWHM / FWTM 16.0° / 32.0° Efficiency 89 % Peak intensity 7.8 cd/lm LEDs/each optic 1 Light colour White Required components:</p>	
<p>NICHIA</p> <p>LED NVSW519A FWHM / FWTM 20.0° / 38.0° Efficiency 85 % Peak intensity 5.2 cd/lm LEDs/each optic 1 Light colour White Required components:</p>	
<p>NICHIA</p> <p>LED NVSxx19B/NVSxx19C FWHM / FWTM 16.0° / 33.0° Efficiency 84 % Peak intensity 6.9 cd/lm LEDs/each optic 1 Light colour White Required components:</p>	

OPTICAL RESULTS (SIMULATED):

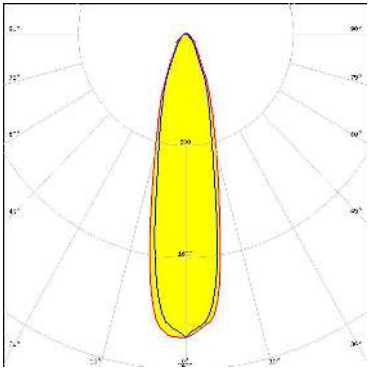
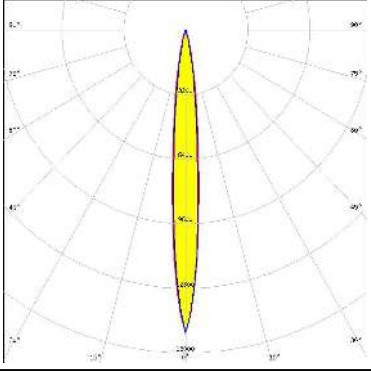
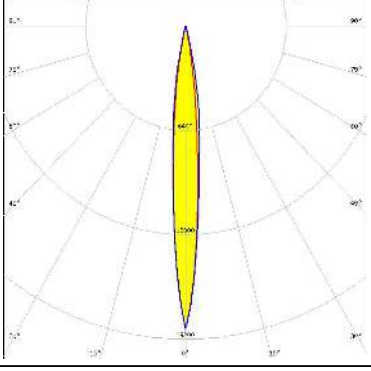
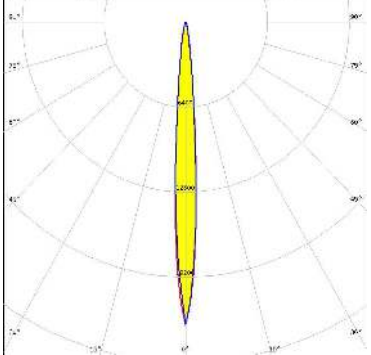
<p>OSRAM Opto Semiconductors</p> <p>LED Duris S8</p> <p>FWHM / FWTM 25.0° / 59.0°</p> <p>Efficiency 85 %</p> <p>Peak intensity 2.2 cd/lm</p> <p>LEDs/each optic 1</p> <p>Light colour White</p> <p>Required components:</p>	
<p>OSRAM Opto Semiconductors</p> <p>LED KW CULPM1.TG</p> <p>FWHM / FWTM 10.0° / 24.0°</p> <p>Efficiency 89 %</p> <p>Peak intensity 15.1 cd/lm</p> <p>LEDs/each optic 1</p> <p>Light colour White</p> <p>Required components:</p>	
<p>OSRAM Opto Semiconductors</p> <p>LED PLPVEC2 850A</p> <p>FWHM / FWTM 10.0° / 23.0°</p> <p>Efficiency 93 %</p> <p>LEDs/each optic 1</p> <p>Light colour IR</p> <p>Required components:</p>	
<p>OSRAM Opto Semiconductors</p> <p>LED SFH 4232A</p> <p>FWHM / FWTM 8.0° / 19.0°</p> <p>Efficiency 94 %</p> <p>LEDs/each optic 1</p> <p>Light colour IR</p> <p>Required components:</p>	

OPTICAL RESULTS (SIMULATED):

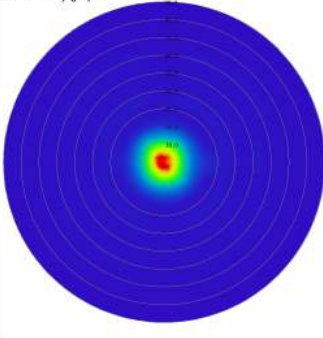
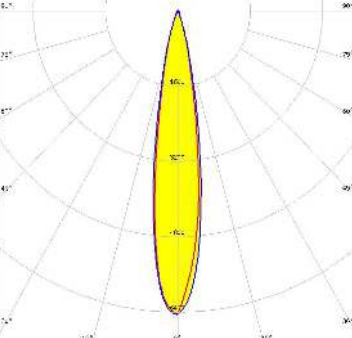
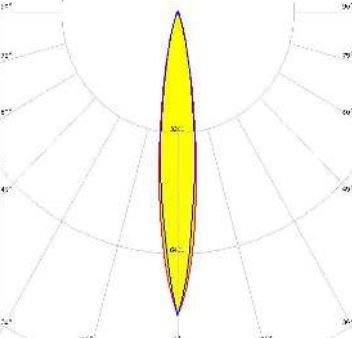
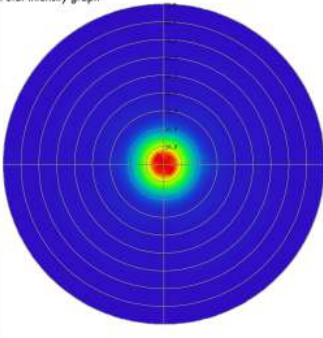
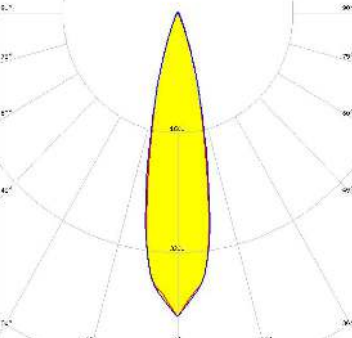
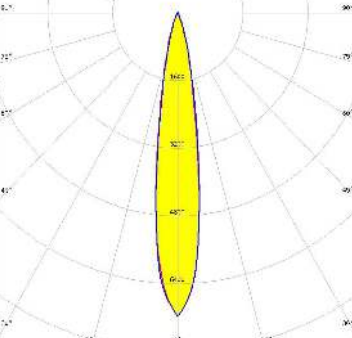
<p>OSRAM Opto Semiconductors</p> <p>LED SFH 4715AS FWHM / FWTM 17.0° / 35.0° Efficiency 88 % LEDs/each optic 1 Light colour IR Required components:</p>	<p>Polar intensity graph</p> 	
<p>OSRAM Opto Semiconductors</p> <p>LED SFH 4725S FWHM / FWTM 14.0° / 32.0° Efficiency 88 % LEDs/each optic 1 Light colour IR Required components:</p>		
<p>OSRAM Opto Semiconductors</p> <p>LED SFH 4727AS FWHM / FWTM 23.0° / 42.0° Efficiency 86 % LEDs/each optic 1 Light colour IR Required components:</p>	<p>Polar intensity graph</p> 	
<p>SAMSUNG</p> <p>LED LH351C FWHM / FWTM 16.0° / 34.0° Efficiency 91 % Peak intensity 7.2 cd/lm LEDs/each optic 1 Light colour White Required components:</p>		

GENERAL INFORMATION:

NOTE: The typical beam angle will be changed by different color, chip size and chip position tolerance. The typical total beam angle is the full angle measured where the luminous intensity is half of the peak value.

MATERIALS:

As part of our continuous research and improvement processes, and to ensure the best possible quality and availability of our products, LEDiL reserves the right to change material grades without notice.

PRODUCT DATA USER AGREEMENT AND DISCLAIMER:

The measured data in the provided downloadable LEDiL Product Datasheets and Mechanical 2D-Drawings is rounded and provided as reference for planning. LEDiL Oy's optical specifications have been verified by conducting performance testing of the products in accordance with the company's quality system. The reported data are averaged results of multiple measurements with typical variation. LEDiL Oy reserves the right to without prior notification make changes and improvements to its products.

LEDiL Oy assumes neither warranty, nor guarantee nor any other liability of any kind for the contents and correctness of the provided data. The provided data has been generated with highest diligence but the provided data may in reality not represent the complete possible variation range of all intrinsic parameters. Therefore, in certain cases a deviation from the provided data could occur.

LEDiL Oy reserves the right to undertake technical changes of its products without further notification which could lead to changes in the provided data. LEDiL Oy assumes no liability of any kind for the possible deviation from any provided data or any other damage resulting from the usage of the provided data.

The user agrees to this disclaimer and user agreement with the download or usage of the provided files.

LEDiL Oy

Joensuunkatu 13
FI-24240 SALO
Finland

LEDiL Inc.

228 West Page Street
Suite D
Sycamore IL 60178
USA

Ledil Optics Technology (Shenzhen) Co., Ltd.

405 , Block B
Casic Motor Building
Shenzhen 518057
P.R.CHINA

Local sales and technical support

[www.ledil.com/
where_to_buy](http://www.ledil.com/where_to_buy)

Shipping locations

Salo, Finland
Hong Kong, China

Distribution Partners

[www.ledil.com/
where_to_buy](http://www.ledil.com/where_to_buy)