

△数	訂正事項	檢圖	年月日	△数	訂正事項	檢圖	年月日
COUNT	DESCRIPTION OF REVISIONS	CHKD	DATE	COUNT	DESCRIPTION OF REVISIONS	CHKD	DATE
1	RE-6-1150	KIY	18.07.04				
2	RE-6-1579	KIY	20.01.23				

RECOMMENDED LAND PATTERN (FREE)
 (PCB THICKNESS t=1.6mm)

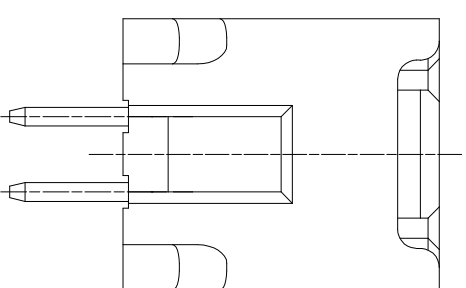

ENGAGEMENT FIGURE (2:1)

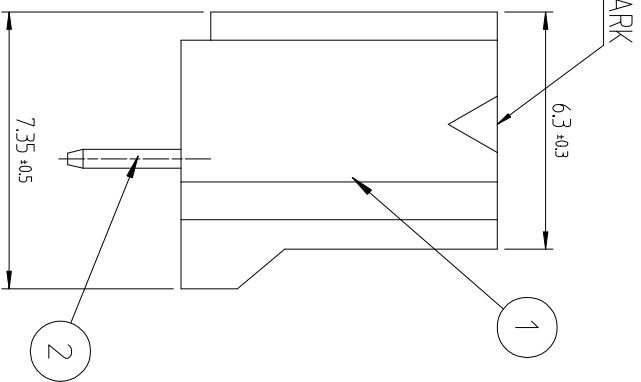
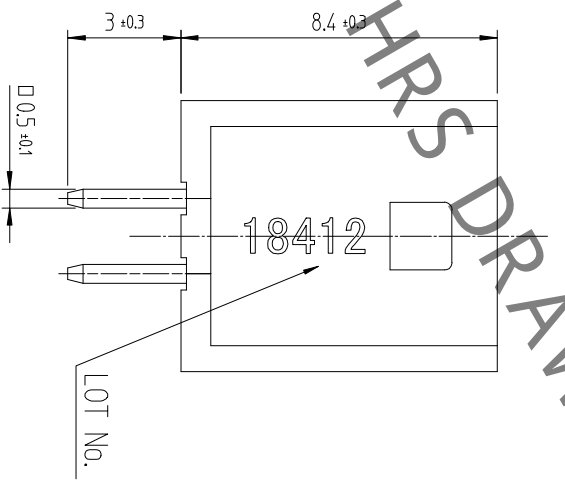
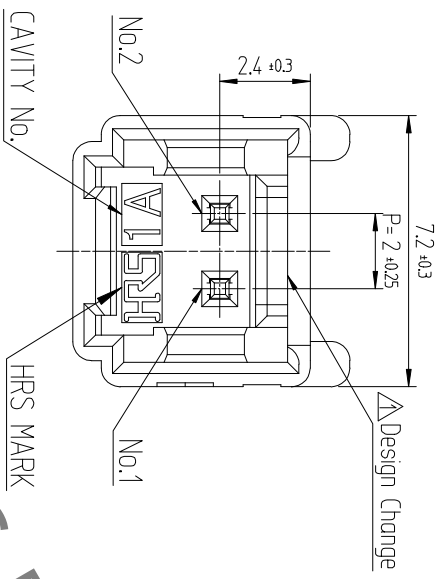
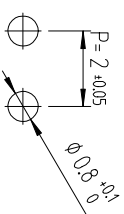
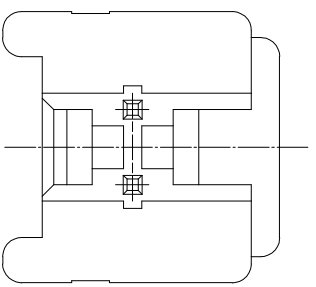
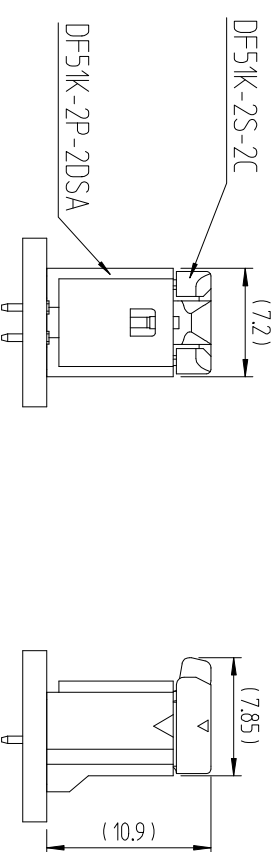

NOTE 1. 1PACK CONTAINS 100PCS.

2. () DIMENSIONS ARE ONLY REFERENCE.

△ 3. UL(IEC No. E132750) AUTHORIZATION ARTICLE.

C-UL(IEC No. E132750) AUTHORIZATION ARTICLE.



1	△ PA66	UL94V-0, BLACK	2	BRASS	TIN PLATING 1μm MIN, OVER NICKEL 0.5μm MIN
NO.	MATERIAL	FINISH/REMARKS	NO.	MATERIAL	FINISH/REMARKS
CODE NO. (OLD)		DRAWN	CHECKED		APPROVED
		CHOI 17.12.22 J.S	LIM 17.12.22 S.M		KANG 17.12.22 T.S
SCALE		DESIGNED		RELEASED	
5:1		CHOI 17.12.22 J.S		ENG 20.02.12 DEPT	
UNITS		PART NO.		CODE NO.	
mm		DF51K-2P-2DSA (800)		CL 6652-0001-1-800	
DRAWING NO.		PART NO.		CODE NO.	
EDC3-632302		DF51K-2P-2DSA (800)		CL 6652-0001-1-800	
HRS HIROSE KOREA CO.,LTD.					