

ATAVRAUTO102 Kit

User Guide



Section 1
Introduction 1-1
 1.1 Overview1-1

Section 2
Getting Started..... 2-3
 2.1 Unpacking the system.....2-3
 2.2 System Requirements.....2-3

Section 3
Using the ATAVRAUTO102..... 3-5
 3.1 Using the ATAVRAUTO102 board.....3-5
 3.2 Updating the ATAVRAUTO102 firmware3-5
 3.3 Using X-Analyser3-8

Section 4
Technical specification..... 4-11

Section 5
Technical support 5-12

Section 6
Complete schematics 6-13

Congratulations on your purchase of the ATAVRAUTO102 starter kit. This document describes the board included in the ATAVRAUTO102 starter kit dedicated to AT90CAN128 and AT90USB1287.

1.1 Overview

This document describes the ATAVRAUTO102 dedicated to AT90CAN128 and AT90USB1287 AVR microcontrollers. This board is designed to allow an easy evaluation of the products using demonstration software.

This board is not a development platform but a tool designed to give designers a quick start to analyze LIN and/or CAN networks in order to evaluate Atmel LIN and CAN solutions.

Figure 1-1. ATAVRAUTO102

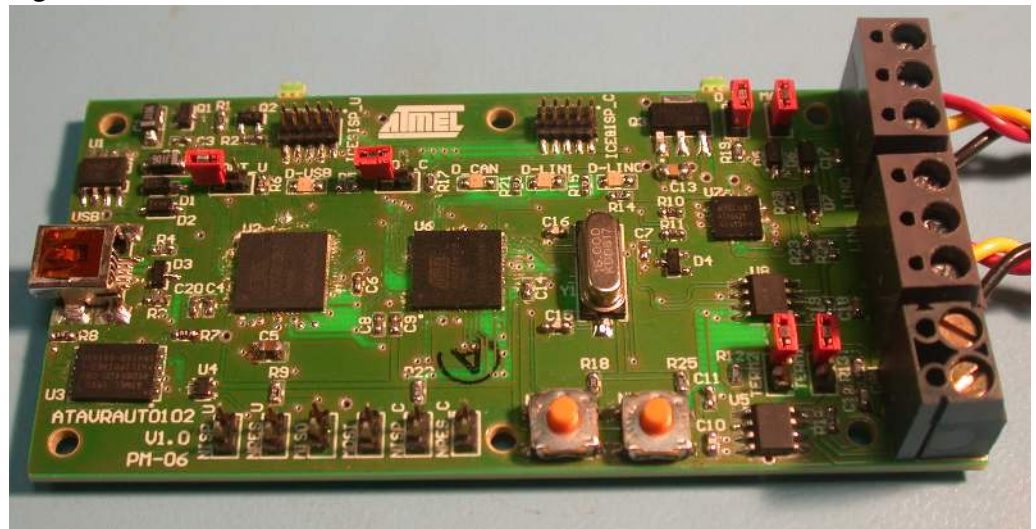

1.2 ATAVRAUTO102 features

The ATAVRAUTO102 provides the following features:

- AT90CAN128 and AT90USB1287 QFN64
- AVR programming tools interface⁽¹⁾,
- Power supply
 - Regulated 5V
 - From LIN and/or USB connector
- JTAG connector:
 - For on-chip In Situ Programming (ISP)
 - For on-chip debugging using JTAG ICE
- Serial interfaces:
 - 2 LIN interface 1.3 and 2.0 compliant (Software library available on the Atmel website for LIN 1.3)
 - 1 CAN interface
- On-board resources:
 - 1 LIN transceiver with internal regulator + watchdog (ATA6621)
 - 1 LIN transceiver (ATA6661)
 - 1 CAN transceiver (ATA6660)
 - 8 Mbytes of DataFlash
- System clock:
 - Internal RC oscillator
 - 16Mhz external quartz connected to the AT90CAN128
 - Clock output from the AT90CAN128 connected to the clock input of the AT90USB1287.
- Dimension: 92 mm x 45 mm

Notes: 1. AT90CAN128 and AT90USB1287 are supported by AVR Studio, version 4.12 or higher. For up-to-date information on this and other AVR tool products, please consult our web site. The newest version of AVR Studio, AVR tools and this user guide can be found in the AVR section of the Atmel web site, <http://www.atmel.com>.



Section 2

Getting Started

2.1 Unpacking the system

Kit contents:

- 1 ATAVRAUTO102 board V1.0
- 1 ATAVRAUTO900 board V1.0
- 1 USB Mini-B to A cable
- 1 Getting Started
- 1 Automotive CD-Rom
- 1 AVR CD-Rom software and technical library
- 1 Dear customer letter

2.2 System Requirements

The ATAVRAUTO102 board is used as a tool to analyze car networks (up to two LIN networks and one CAN network). The minimum hardware and software PC requirements are:

- Windows® 2000/XP, Windows NT4.0 or higher

Note: No drivers are needed.

2.3 Quick Start

The ATAVRAUTO102 board can be used to analyze up to one CAN and two LIN networks. Connect networks (LIN and/or CAN) and plug USB cable.

Figure 2-1. Board connections and default jumper settings

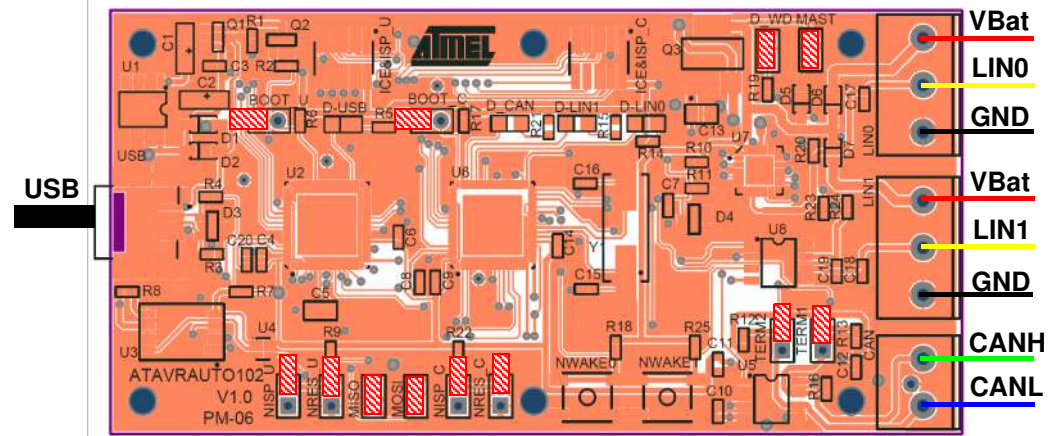

Note: At least one “VBat” should be connected to have the LIN interfaces working.

Table 2-1. Main Jumpers function

Jumper	Description
D_WD	Set to disable the LIN transceiver watch dog (default REMOVED).
MAST	Set to use the master mode of LIN0 (default SET).
MISO	Set to enable the SPI comm between both microcontrollers (default SET).
MOSI	
TERM1	Set to enable the CAN termination resistors (default REMOVED)..
TERM2	
NISP_U	Set to enable the reset signal from the LIN transceiver to the AT90CAN128 (_C) or/and the aT90USB1287 (_U) microcontrollers (default SET)
NISP_C	
NRES_U	Set to reset the AT90CAN128 (_C) or the AT90USB1287 (_U) microcontroller (default REMOVED).
NRES_C	
BOOT_U	Reserved for future use (default REMOVED).
BOOT_U	

The default configuration allows to use the board with LIN and CAN.

Note: For more details on ATAVRAUTO102 options, please refer to “Using ATAVRAUTO102” chapter of the user guide.





Section 3

Using the ATAVRAUTO102

3.1 Using the ATAVRAUTO102 board

The ATAVRAUTO102 can be used as a spy on a network or can act as a single Slave or Master node.

- LIN0 can be sniffer/slave or master.
- LIN1 can be sniffer or slave.
- CAN can be sniffer or master.

Steps to follow:

- Connect your board to your PC using the USB cable.
- Link all networks you want to work with.
- If LIN0 is a master node, set the jumper MAST.
- Run "X-Analyser".

3.2 Updating the ATAVRAUTO102 firmware

For the future firmware revision, the ATAVRAUTO900 will be used to update AT90CAN128 and AT90USB1287 microcontrollers.

Note: When programming, NISP_C and NISP_U jumpers have to be removed.

The AT90CAN128 and the AT90USB1287 can be programmed using specific SPI links. This sub section will explain how to connect the programmer.

The FLASH, EEPROM memory (and all Fuse and Lock Bit Option ISP-programmable) can be programmed individually or with the sequential automatic programming option.

3.2.1 Using the ATAVRAUTO900 Adaptor

The AVR ISP is a compact and easy-to-use In-System Programming tool for developing applications with AT90CAN128. Due to the small size, it is also an excellent tool for field upgrades of existing applications. It is powered by the ATAVRAUTO102 and an additional power supply is thus not required. The AVR ISP programming interface is integrated in AVR Studio®. An additional adaptor has to be used to program the board using ISP or JTAG mode. The 10 pins connector is used for the JTAGICE mkII device and the 6 pins connector is used for the AVRISP device. To plug the ATAVRAUTO900 connector to the board, the arrow (on the adaptor) has to be in front of the point (on the board).

Figure 3-1. ATAVRAUTO900 Connection

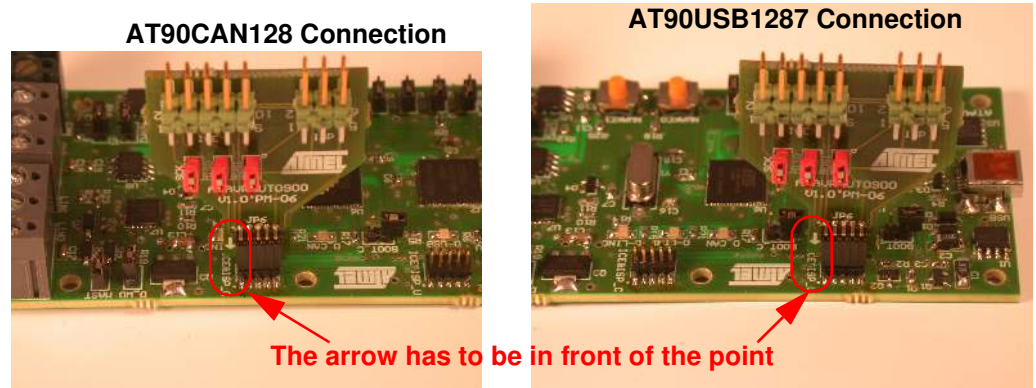

Table 3-1. ICE Connector

PIN	Function
1	TCK
2	GND
3	TDO
4	VCC
5	TMS
6	NRES
7	VCC
8	NC
9	TDI
10	GND

Table 3-2. ISP Connector

PIN	Function
1	MISO
2	VCC
3	SCK
4	MOSI
5	NRES
6	GND

3.2.2 Programming with AVR ISP via SPI

Both the Flash and EEPROM memory arrays can be programmed using the serial SPI bus while RESET is pulled to GND. The serial interface consists of pins SCK, MOSI (input) and MISO (output). After RESET is set low, the Programming Enable instruction needs to be executed first before program/erase operations can be executed. Note that throughout the description about Serial downloading, MOSI and MISO are used to describe the serial data in and serial data out respectively. For AT90CAN128 these pins are mapped to PDI (PE0) and PDO (PE1).

To program the device using AVR ISP programmer, connect the AVR ISP to the adaptor (ATAVRAUTO900) and connect the adaptor to the connector of the ATAVRAUTO102.

Programming the ATAVRAUTO102 using ATAVRAUTO 900



3.2.3 Programming with AVR JTAGICE mkII

The AT90CAN128 can be programmed using specific JTAG link: 3-wire debug-wire interface. To use the AVR JTAGICE mkII with an ATAVRAUTO100 an optional adaptor should be used. Then the JTAG probe can be connected to the ATAVRAUTO100 as shown in the following figure.

JTAGICE mkII probe connection through JTAG interface.

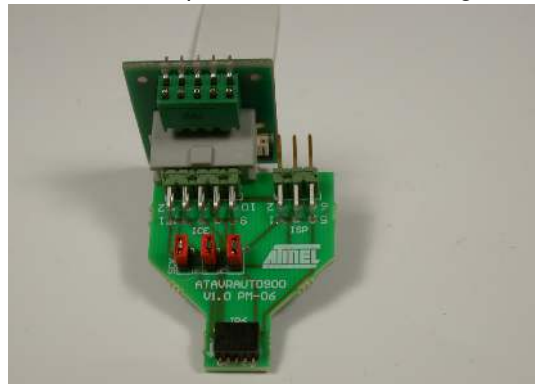

3.3.1 Speed limitations

- The limitation of the USB HID Class implies a limitation if the bit rate : the maximal HID baudrate is 64 KByte/s, so 512 Kb/s. So, for a CAN Baudrate higher than 500Kb/s, a CAN load higher than 50% will imply the loss of CAN frames.
- The Windows Operating System also implies limitations for the application: If ATAnalyser is the only running application, the O.S. allows the application to received USB frames only every 10 ms. A buffer permits to save received USB frames but for very high bitrates, there could be a loss of received USB frames.



Section 4

Technical specification

- System Unit
 - Physical Dimensions.....L=92 x W=45 x H=14 mm
 - Weight.....31 g
- Operating Conditions
 - Internal Voltage Supply (Flash).....3.3V
 - Internal Voltage Supply (Micro)..... 5.0V
 - External Voltage Supply.....7V -18V



Section 5

Technical support

For Technical support, please contact avr@Atmel.com. When requesting technical support, please include the following information:

- Which target AVR device is used (complete part number)
- Target voltage and speed
- Clock source and fuse setting of the AVR
- Programming method (ISP, JTAG or specific Boot-Loader)
- Hardware revisions of the AVR tools, found on the PCB
- Version number of AVR Studio. This can be found in the AVR Studio help menu.
- PC operating system and version/build
- PC processor type and speed
- A detailed description of the problem



Section 6

Complete schematics

On the next pages, the following documents of ATAVRAUTO102 are shown:

- Bill of materials
- Complete schematics
- Assembly drawing

Table 6-1. Bill of Materials

Designator	Descriptions	Reference	Fabricant	Fournisseur	Code Commande	Unité de Vente	Quantity	Prix UDV	LibRef	Footprint
C11	100nF	X7R 16V	Phycomp	FARNELL	432210	10	1	0.63	Cap 100nF 0603 X7R 16V	0603
C14	100nF	X7R 16V	Phycomp	FARNELL	432210	10	1	0.63	Cap 100nF 0603 X7R 16V	0603
C19	100nF	X7R 16V	Phycomp	FARNELL	432210	10	1	0.63	Cap 100nF 0603 X7R 16V	0603
C20	100nF	X7R 16V	Phycomp	FARNELL	432210	10	1	0.63	Cap 100nF 0603 X7R 16V	0603
C3	100nF	X7R 16V	Phycomp	FARNELL	432210	10	1	0.63	Cap 100nF 0603 X7R 16V	0603
C4	100nF	X7R 16V	Phycomp	FARNELL	432210	10	1	0.63	Cap 100nF 0603 X7R 16V	0603
C6	100nF	X7R 16V	Phycomp	FARNELL	432210	10	1	0.63	Cap 100nF 0603 X7R 16V	0603
C7	100nF	X7R 16V	Phycomp	FARNELL	432210	10	1	0.63	Cap 100nF 0603 X7R 16V	0603
C8	100nF	X7R 16V	Phycomp	FARNELL	432210	10	1	0.63	Cap 100nF 0603 X7R 16V	0603
C9	100nF	X7R 16V	Phycomp	FARNELL	432210	10	1	0.63	Cap 100nF 0603 X7R 16V	0603
C12	100pF	COG	MURATA	FARNELL	8819866	10	1	0.54	Cap 100pF 0603 COG 50V	0603
C10	15pF	COG	AVX	FARNELL	7568320	10	1	2.2	Cap 15pF 0603 COG 200V	0603
C15	15pF	COG	AVX	FARNELL	7568320	10	1	2.2	Cap 15pF 0603 COG 200V	0603
C16	15pF	COG	AVX	FARNELL	7568320	10	1	2.2	Cap 15pF 0603 COG 200V	0603
C17	220pF	X7R 50V	Phycomp	FARNELL	722133	25	1	1	Cap 220pF 0603 X7R 50V	0603
C18	220pF	X7R 50V	Phycomp	FARNELL	722133	25	1	1	Cap 220pF 0603 X7R 50V	0603
C5	1µF	X7R	Murata	FARNELL	9527710	25	1	1.25	Cap 1µF 805 16V	0805
C13	4.7µF/6.3V	X5R	MURATA	FARNELL	9522999	10	1	3.1	Cap 4.7µF 0805 6.3V	0805
C1	10µF	TAJA106K006R	AVX	FARNELL	197014	5	1	1.15	Cap 10µF TantaA 6.3V	Capa Tantal A
C2	10µF	TAJA106K006R	AVX	FARNELL	197014	5	1	1.15	Cap 10µF TantaA 6.3V	Capa Tantal A
CAN	Bornier 1X2	20.101/2	IMO	FARNELL	9632670	5	1	1.3	Bornier 1X2 24A	IMO2 5mm
LIN0	Bornier 1X3	20.101/3	IMO	FARNELL	9632689	5	1	1.75	Bornier 1X3 24A	IMO3 5mm
LIN1	Bornier 1X3	20.101/3	IMO	FARNELL	9632689	5	1	1.75	Bornier 1X3 24A	IMO3 5mm
ICE&ISP_C	ICE&ISP Header	M50-3600542	HARWIN	FARNELL	1022310	5	1	3.1	AVR ICE ISP PIN Header 2X5	PIN Header 2x5 1.27mm
ICE&ISP_U	ICE&ISP Header	M50-3600542	HARWIN	FARNELL	1022310	5	1	3.1	AVR ICE ISP PIN Header 2X5	PIN Header 2x5 1.27mm
USB	USB MiniAB	565790576	MOLEX	FARNELL	9786490	1	1	0.78	USB mini AB	USB Mini AB
U3	AT45DB642D	AT45DB642D-CNU	ATMEL	ATMEL	AT45DB642D-CNU	1	1	0	AT45DB642D	CASON
U6	AT90CAN128	AT90CAN128-16MI	ATMEL	ATMEL	AT90CAN128-16MI	1	1	0	AT90CAN128	QFN9X9-64 No VIA
U2	AT90USB1287	AT90USB1287-16MU	ATMEL	ATMEL	90USB1287-16MU	1	1	0	AT90USB128	QFN9X9-64 No VIA
U7	ATA6621	ATA6621	ATMEL	ATMEL	ATA6621	1	1	0	ATA6621	QFN5X5-20 NO VIA
U5	ATA6660	ATA6660	ATMEL	ATMEL	ATA6660	1	1	0	ATA6660	S08
U8	ATA6661	ATA6661-TAQ	ATMEL	ATMEL	ATA6661-TAQ	1	1	0	ATA6661	S08
U1	KF33BD	KF33BD	ST	FARNELL	9755314	1	1	1.04	KF33BD	S08
U4	MC74VHC1GT125	MC74VHC1GT125DF1	ON	AVNET	74VHC1GT125DF1	3000	1	129.00	MC74VHC1GT125	SC70-5
Y1	16MHz	LF A161G	CMAIC	FARNELL	9713908	1	1	2.26	Crystal 16Mhz HC49	HC49/4H_SMX
BOOT_C	2mm V	M22-2010205	HARWIN	FARNELL	671915	10	1	1.12	Jump 2 Vert - 2mm	SIL2V2mm
BOOT_U	2mm V	M22-2010205	HARWIN	FARNELL	671915	10	1	1.12	Jump 2 Vert - 2mm	SIL2V2mm
D_WD	2mm V	M22-2010205	HARWIN	FARNELL	671915	10	1	1.12	Jump 2 Vert - 2mm	SIL2V2mm
MAST	2mm V	M22-2010205	HARWIN	FARNELL	671915	10	1	1.12	Jump 2 Vert - 2mm	SIL2V2mm
MISO	2mm V	M22-2010205	HARWIN	FARNELL	671915	10	1	1.12	Jump 2 Vert - 2mm	SIL2V2mm
MOSI	2mm V	M22-2010205	HARWIN	FARNELL	671915	10	1	1.12	Jump 2 Vert - 2mm	SIL2V2mm
NISP_C	2mm V	M22-2010205	HARWIN	FARNELL	671915	10	1	1.12	Jump 2 Vert - 2mm	SIL2V2mm
NISP_U	2mm V	M22-2010205	HARWIN	FARNELL	671915	10	1	1.12	Jump 2 Vert - 2mm	SIL2V2mm
NRES_C	2mm V	M22-2010205	HARWIN	FARNELL	671915	10	1	1.12	Jump 2 Vert - 2mm	SIL2V2mm
NRES_U	2mm V	M22-2010205	HARWIN	FARNELL	671915	10	1	1.12	Jump 2 Vert - 2mm	SIL2V2mm
TERM1	2mm V	M22-2010205	HARWIN	FARNELL	671915	10	1	1.12	Jump 2 Vert - 2mm	SIL2V2mm
TERM2	2mm V	M22-2010205	HARWIN	FARNELL	671915	10	1	1.12	Jump 2 Vert - 2mm	SIL2V2mm
NWAKE0	Bouton poussoir CMS	KSC421JLFS	ITT CANNON	FARNELL	1201417	1	1	0.42	BP SPNO CMS	BP SPNO
NWAKE1	Bouton poussoir CMS	KSC421JLFS	ITT CANNON	FARNELL	1201417	1	1	0.42	BP SPNO CMS	BP SPNO
D4	BZX84-C5V1	BZX84-C5V1	Philips	FARNELL	1081430	5	1	1	ZENER BZX84-C5V1	SOT23
D_CAN	LED CMS Blue	HSMB-C170	Agilent	FARNELL	3225100	1	1	0.51	LED CMS Blue	LED CMS Agilent
D-LIN0	LED CMS Green	HSMG-C170	Agilent	FARNELL	5790852	5	1	0.8	LED CMS Green	LED CMS Agilent
D-LIN1	LED CMS Green	HSMG-C170	Agilent	FARNELL	5790852	5	1	0.8	LED CMS Green	LED CMS Agilent
D-USB	LED CMS Yellow	HSMY-C170	Agilent	FARNELL	5790876	5	1	0.8	LED CMS Yellow	LED CMS Agilent
D1	MBR0540	MBR0540T1G	ON	FARNELL	9569233	1	1	0.65	Schottky 40V 500mA MBR0540	SOD123
D2	MBR0540	MBR0540T1G	ON	FARNELL	9569233	1	1	0.65	Schottky 40V 500mA MBR0540	SOD123
D5	MBR0540	MBR0540T1G	ON	FARNELL	9569233	1	1	0.65	Schottky 40V 500mA MBR0540	SOD123
D6	MBR0540	MBR0540T1G	ON	FARNELL	9569233	1	1	0.65	Schottky 40V 500mA MBR0540	SOD123
D7	MBR0540	MBR0540T1G	ON	FARNELL	9569233	1	1	0.65	Schottky 40V 500mA MBR0540	SOD123
D3	PESD5V0S2BT	PESD5V0S2BT	PHILIPS	FARNELL	8737720	5	1	2.9	PESD5V0S2BT	SOT23
R2	100K	MC 0.063W 0603 1% 100K	MULTICOMP	FARNELL	9330402	50	1	1.4	Res 100K 0603 1%	0603
R22	100K	MC 0.063W 0603 1% 100K	MULTICOMP	FARNELL	9330402	50	1	1.4	Res 100K 0603 1%	0603
R6	100K	MC 0.063W 0603 1% 100K	MULTICOMP	FARNELL	9330402	50	1	1.4	Res 100K 0603 1%	0603
R7	100K	MC 0.063W 0603 1% 100K	MULTICOMP	FARNELL	9330402	50	1	1.4	Res 100K 0603 1%	0603
R8	100K	MC 0.063W 0603 1% 100K	MULTICOMP	FARNELL	9330402	50	1	1.4	Res 100K 0603 1%	0603
R9	100K	MC 0.063W 0603 1% 100K	MULTICOMP	FARNELL	9330402	50	1	1.4	Res 100K 0603 1%	0603
R1	10K	MC 0.063W 0603 1% 10K	MULTICOMP	FARNELL	9330399	50	1	1.4	Res 10K 0603 1%	0603
R17	10K	RC21	Phycomp	FARNELL	9233504	50	1	1.9	Res 10K 0603 1%	0603
R18	10K	RC21	Phycomp	FARNELL	9233504	50	1	1.9	Res 10K 0603 1%	0603
R19	10K	RC21	Phycomp	FARNELL	9233504	50	1	1.9	Res 10K 0603 1%	0603
R25	10K	RC21	Phycomp	FARNELL	9233504	50	1	1.9	Res 10K 0603 1%	0603
R10	120K	MC 0.063W 0603 1% 120K	MULTICOMP	FARNELL	9238735	50	1	1.4	Res 120K 0603 1%	0603
R16	1K	RC22H	Phycomp	FARNELL	9238484	50	1	2.17	Res 1K 0603 1%	0603
R20	1K	RC22H	Phycomp	FARNELL	9238484	50	1	2.17	Res 1K 0603 1%	0603
R24	22R	MC 0.063W 0603 1% 22R	MULTICOMP	FARNELL	9330844	50	1	1.4	Res 22R 0603 1%	0603
R3	22R	RC22H	Phycomp	FARNELL	9238280	50	1	1.95	Res 22R 0603 1%	0603
R4	22R	RC22H	Phycomp	FARNELL	9238280	50	1	1.95	Res 22R 0603 1%	0603
R14	330R	MC 0.063W 0603 1% 330R	Phycomp	FARNELL	9331018	50	1	1.4	Res 330R 0603 1%	0603
R15	330R	MC 0.063W 0603 1% 330R	Phycomp	FARNELL	9331018	50	1	1.4	Res 330R 0603 1%	0603
R21	330R	MC 0.063W 0603 1% 330R	Phycomp	FARNELL	9331018	50	1	1.4	Res 330R 0603 1%	0603
R5	330R	MC 0.063W 0603 1% 330R	Phycomp	FARNELL	9331018	50	1	1.4	Res 330R 0603 1%	0603
R11	47K	MC 0.063W 0603 1% 47K	MULTICOMP	FARNELL	9238889	50	1	1.4	Res 47K 0603 1%	0603
R23	51K	MC 0.063W 0603 1% 51K	MULTICOMP	FARNELL	9331310	50	1	1.4	Res 51K 0603 1%	0603
R12	56R	RC22H	Phycomp	FARNELL	9238336	50	1	2.17	Res 56R 0603 1%	0603
R13	56R	RC22H	Phycomp	FARNELL	9238336	50	1	2.17	Res 56R 0603 1%	0603
O2	BC847	BC847	PHILIPS	FARNELL	1081230	10	1	1	BC847	SOT23
O3	BCP54	BCP54-10	PHILIPS	FARNELL	8734828	1	1	0.63	BCP54	SOT223
O1	SI2301BDS	SI2301BDS	VISHAY	FARNELL	8156670	5	1	2.7	SI2301BDS	SOT23-GSD



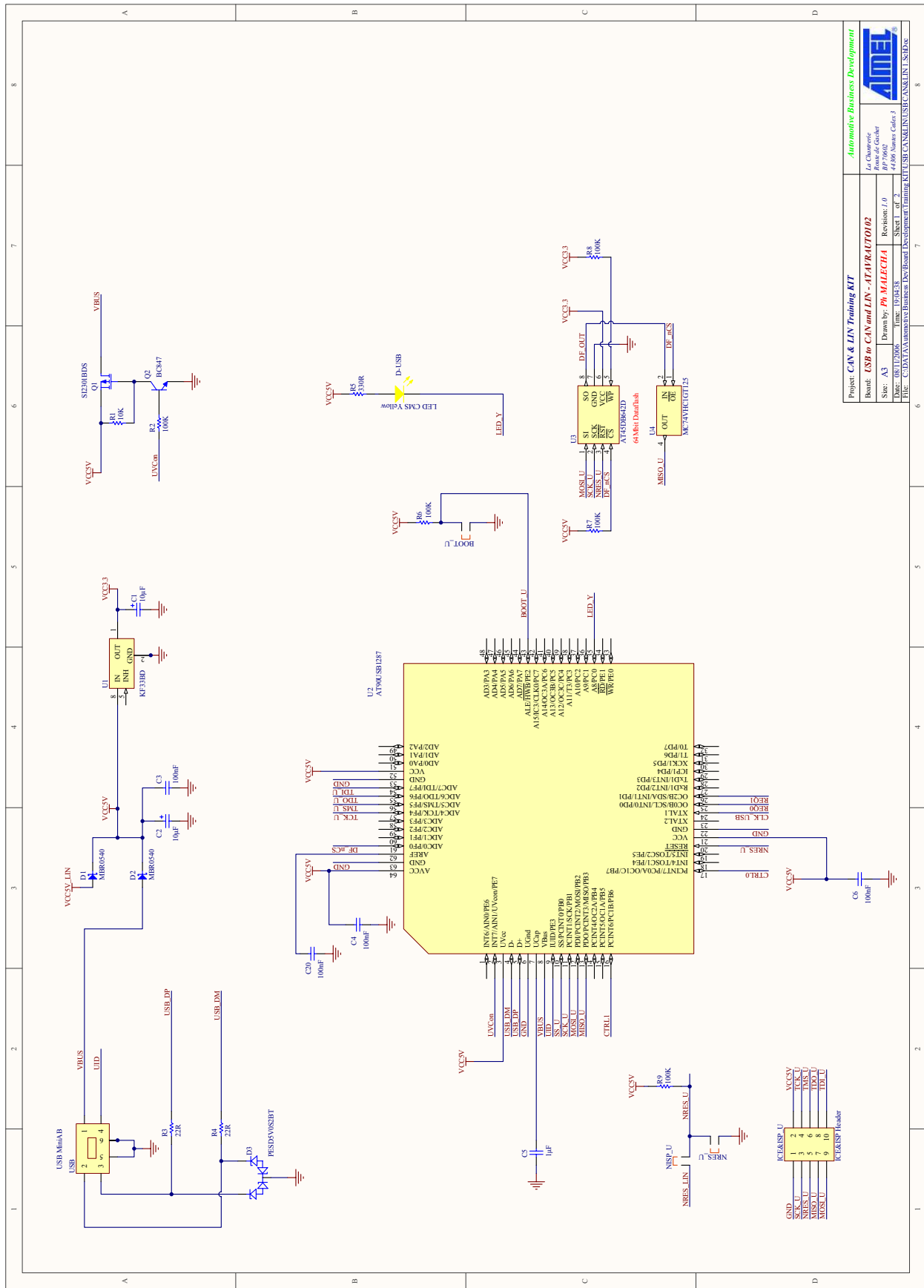

Project: CAN & LIN Training KIT
 Board: USB to CAN and LIN - ATAVRAUTO102
 Atmel Member: Ravi Raj Gokhar
 Rev: B779602
 Size: A3
 Drawn by: PH MALECHA
 Date: 08/12/2008
 Time: 19:04:38
 Sheet 1 of 2
 44-000 Names Code:3
 FILE: C:\DATA\Automotive Business Dev\Board Development\Training KIT\USB\CAN\LIN\USB\CAN\LIN1.SSDoc



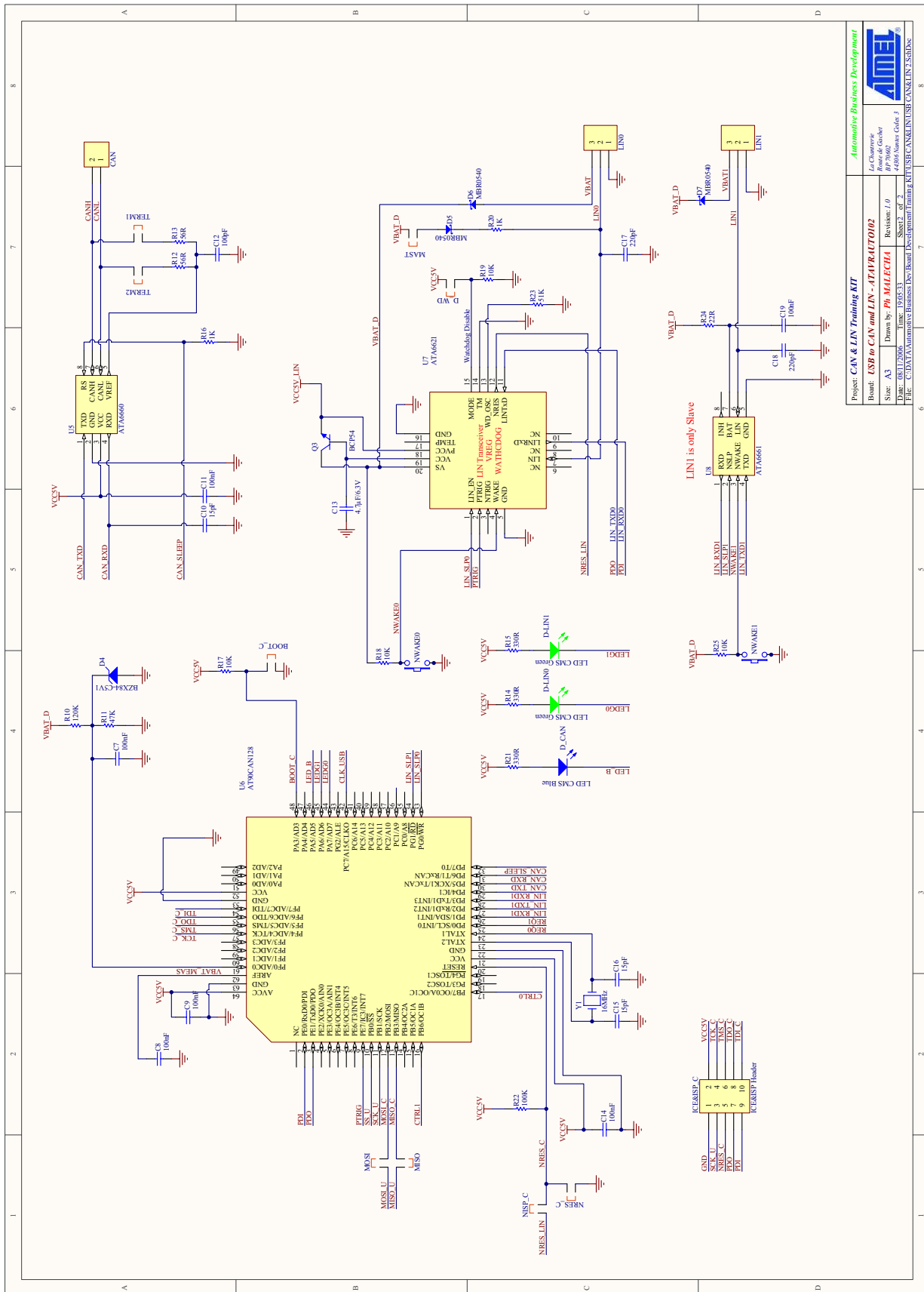

Project: CAN & LIN Training KIT
 Board: USB to CAN and LIN - ATAVRAUTO102
 Size: A3
 Date: 08/11/2006
 Time: 19:05:33
 File: C:\DATA\Automotive Business Dev\Board Development\training KIT\USB\CAN\LIN\USB_CAN\LIN_V2.SchDoc

Automotive Business Development
 Leo Chalmers
 Romain Guichard
 R.P. 79000
 44 Avenue de la Libération
 92000 Nanterre Cedex 3
 Revision: 1.0
 Sheet 2 of 2



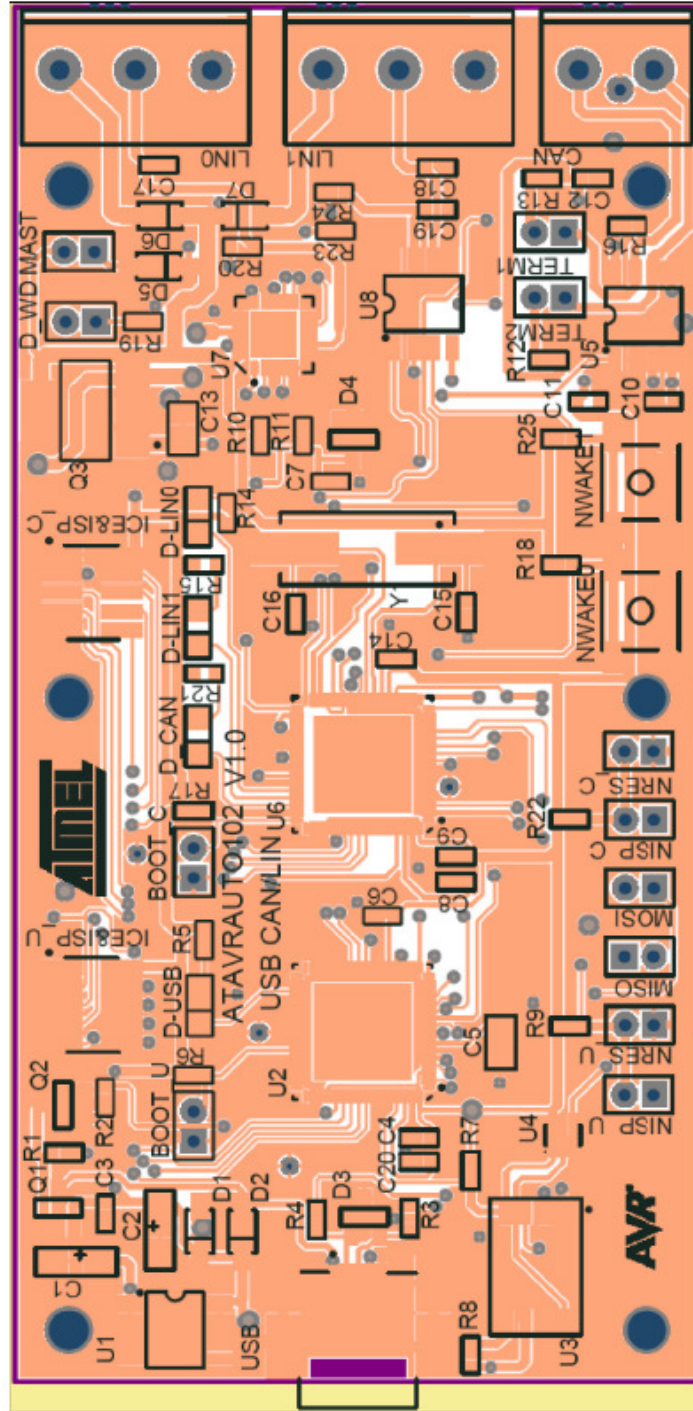



Atmel Corporation

2325 Orchard Parkway
San Jose, CA 95131, USA
Tel: 1(408) 441-0311
Fax: 1(408) 487-2600

Regional Headquarters

Europe

Atmel Sarl
Route des Arsenalux 41
Case Postale 80
CH-1705 Fribourg
Switzerland
Tel: (41) 26-426-5555
Fax: (41) 26-426-5500

Asia

Room 1219
Chinachem Golden Plaza
77 Mody Road Tsimshatsui
East Kowloon
Hong Kong
Tel: (852) 2721-9778
Fax: (852) 2722-1369

Japan

9F, Tonetsu Shinkawa Bldg.
1-24-8 Shinkawa
Chuo-ku, Tokyo 104-0033
Japan
Tel: (81) 3-3523-3551
Fax: (81) 3-3523-7581

Atmel Operations

Memory

2325 Orchard Parkway
San Jose, CA 95131, USA
Tel: 1(408) 441-0311
Fax: 1(408) 436-4314

Microcontrollers

2325 Orchard Parkway
San Jose, CA 95131, USA
Tel: 1(408) 441-0311
Fax: 1(408) 436-4314

La Chantrerie
BP 70602
44306 Nantes Cedex 3, France
Tel: (33) 2-40-18-18-18
Fax: (33) 2-40-18-19-60

ASIC/ASSP/Smart Cards

Zone Industrielle
13106 Rousset Cedex, France
Tel: (33) 4-42-53-60-00
Fax: (33) 4-42-53-60-01

1150 East Cheyenne Mtn. Blvd.
Colorado Springs, CO 80906, USA
Tel: 1(719) 576-3300
Fax: 1(719) 540-1759

Scottish Enterprise Technology Park
Maxwell Building
East Kilbride G75 0QR, Scotland
Tel: (44) 1355-803-000
Fax: (44) 1355-242-743

RF/Automotive

Theresienstrasse 2
Postfach 3535
74025 Heilbronn, Germany
Tel: (49) 71-31-67-0
Fax: (49) 71-31-67-2340

1150 East Cheyenne Mtn. Blvd.
Colorado Springs, CO 80906, USA
Tel: 1(719) 576-3300
Fax: 1(719) 540-1759

Biometrics/Imaging/Hi-Rel MPU/ High Speed Converters/RF Datacom

Avenue de Rochepleine
BP 123
38521 Saint-Egreve Cedex, France
Tel: (33) 4-76-58-30-00
Fax: (33) 4-76-58-34-80

Literature Requests

www.atmel.com/literature

Disclaimer: The information in this document is provided in connection with Atmel products. No license, express or implied, by estoppel or otherwise, to any intellectual property right is granted by this document or in connection with the sale of Atmel products. **EXCEPT AS SET FORTH IN ATMEL'S TERMS AND CONDITIONS OF SALE LOCATED ON ATMEL'S WEB SITE, ATMEL ASSUMES NO LIABILITY WHATSOEVER AND DISCLAIMS ANY EXPRESS, IMPLIED OR STATUTORY WARRANTY RELATING TO ITS PRODUCTS INCLUDING, BUT NOT LIMITED TO, THE IMPLIED WARRANTY OF MERCHANTABILITY, FITNESS FOR A PARTICULAR PURPOSE, OR NON-INFRINGEMENT. IN NO EVENT SHALL ATMEL BE LIABLE FOR ANY DIRECT, INDIRECT, CONSEQUENTIAL, PUNITIVE, SPECIAL OR INCIDENTAL DAMAGES (INCLUDING, WITHOUT LIMITATION, DAMAGES FOR LOSS OF PROFITS, BUSINESS INTERRUPTION, OR LOSS OF INFORMATION) ARISING OUT OF THE USE OR INABILITY TO USE THIS DOCUMENT, EVEN IF ATMEL HAS BEEN ADVISED OF THE POSSIBILITY OF SUCH DAMAGES.** Atmel makes no representations or warranties with respect to the accuracy or completeness of the contents of this document and reserves the right to make changes to specifications and product descriptions at any time without notice. Atmel does not make any commitment to update the information contained herein. Unless specifically provided otherwise, Atmel products are not suitable for, and shall not be used in, automotive applications. Atmel's products are not intended, authorized, or warranted for use as components in applications intended to support or sustain life.

© 2007 Atmel Corporation. All rights reserved. Atmel®, logo and combinations thereof, and others are registered trademarks or trademarks of Atmel Corporation or its subsidiaries. Other terms and product names may be trademarks of others.



Printed on recycled paper.