

REVISIONS					
REV	ECO	DESCRIPTION	DATE	BY	APPR
A1	-	RELEASE NUMBER	30/NOV/18	ROOKIE	TOMMY

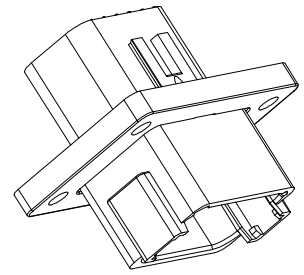
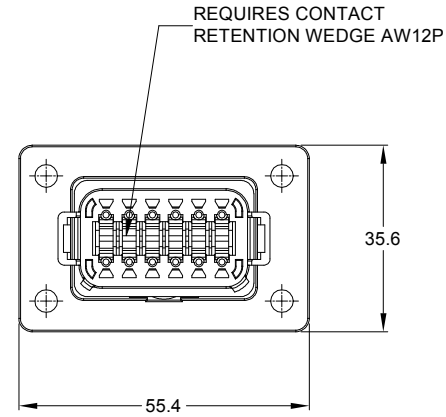
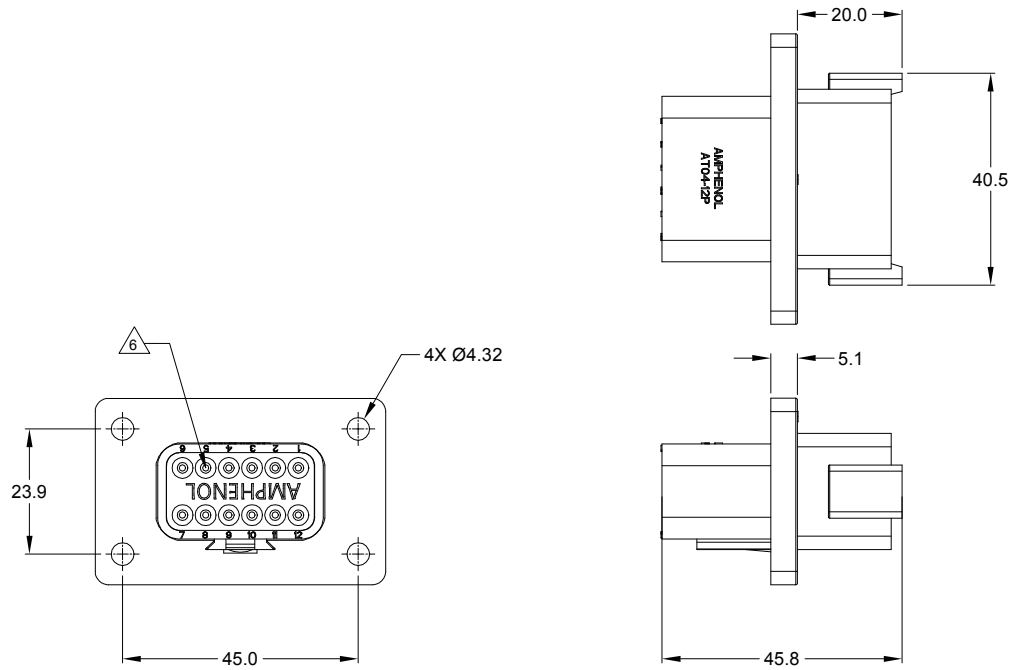

NOTES: UNLESS OTHERWISE SPECIFIED

1. SEE SHEET 2 FOR KEY ARRANGEMENTS AND COLORS.

2. MATERIAL:  
HOUSING: THERMOPLASTIC  
SEAL: SILICONE RUBBER

3. MODIFICATIONS: FLANGE

4. SPECIFICATIONS:  
4.1 CURRENT RATING: 13 AMPS  
4.2 OPERATING TEMPERATURE: -55°C TO +125°C.  
4.3 DIELECTRIC WITHSTANDING VOLTAGE: LESS THAN 2 MILLIAMPS CURRENT LEAKAGE @ 1500 VOLTS AC.  
4.4 INSULATION RESISTANCE: 1000 MEGOHMS MIN @ 25°C.  
4.5 MOISTURE RESISTANCE: IP67 ( MATED CONDITION )  
4.6 MATING CYCLE DURABILITY: 100 CYCLES  
4.7 RoHS COMPLIANT

5. MATING PART: AT06-12SX\* PLUG.  
( X=A,B,C,D KEYS, \* = MODIFICATIONS AND COLORS )

6. ALL DIMENSIONS ARE FOR REFERENCE USE ONLY.

7. CONTACT SIZE AND REAR SEAL WIRE RANGE:

CONTACT SIZE	MIN. INSUL O.D.	MAX. INSUL O.D.	TYPICAL WIRE RANGE
16	2.24 mm (.088 in)	3.68 mm (.145 in)	14 - 20 AWG

TITLE: 12P RECEPTACLE, FLANGE MOUNT  
DWG NO.: AT04-12PX-L012  
REV: A1  
SH: 1  
OF: 3

QUANTITY	SEE SHEET 2 PART NUMBER	DESCRIPTION	ITEM
<b>MATERIALS LIST</b>			
<b>UNLESS OTHERWISE SPECIFIED</b> 1) All dimensions are in metric (mm). 2) Tolerances are as follows: 1 PL DEC ±0.30 Fractions ±1/64 2 PL DEC ±0.15 Angles ±1° 3 PL DEC ±0.08 3) Note reference =		<b>SIGNATURES</b> DRAWN: ROOKIE 30/NOV/18 CHECKED: ORION 30/NOV/18 ENGINEER: APPROVAL: TOMMY 30/NOV/18 CUSTOMER:	<b>DATE</b> 30/NOV/18 30/NOV/18 30/NOV/18
<b>MATERIAL SPECIFICATIONS:</b>		 Sine Systems - www.amphenol-sine.com 44724 Morley Drive Clinton Township, MI 48036	
<b>PROCESS SPECIFICATIONS:</b>		12P RECEPTACLE, FLANGE MOUNT	
<b>NEXT ASSY:</b>		THIS DRAWING IS SUPPLIED FOR INFORMATION ONLY. DESIGN FEATURES, SPECIFICATIONS AND PERFORMANCE DATA SHOWN HEREON ARE THE PROPERTY OF THE AMPHENOL CORPORATION. NO RIGHTS OF REPRODUCTION ARE IMPLIED. ALL DIMENSIONS ARE SUBJECT TO NORMAL MANUFACTURING VARIATIONS.	SCALE: NONE
		<b>SIZE</b> B C-	<b>DWG NO.</b> AT04-12PX-L012 <b>REVISION</b> A1
		SHEET 1 OF 3	

REVISIONS					
REV	ECO	DESCRIPTION	DATE	BY	APPR
A1	-	RELEASE NUMBER	30/NOV/18	ROOKIE	TOMMY

KEY A CONFIGURATION  
STANDARD COLOR:GREY

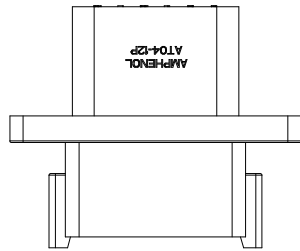

KEY B CONFIGURATION  
STANDARD COLOR:BLACK

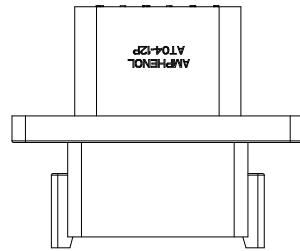

KEY C CONFIGURATION  
STANDARD COLOR:GREEN

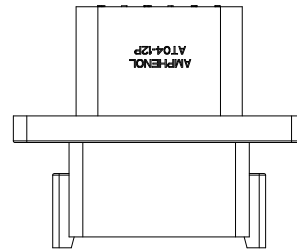

KEY D CONFIGURATION  
STANDARD COLOR:BROWN

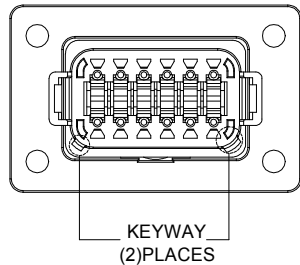
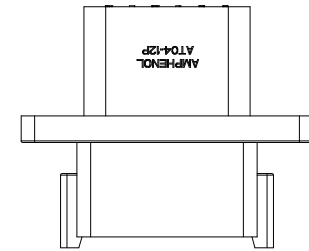

KEYWAY  
(2)PLACES

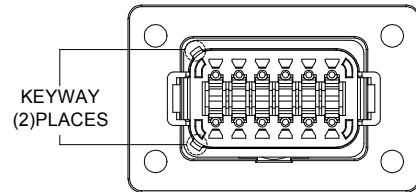

KEYWAY  
(2)PLACES

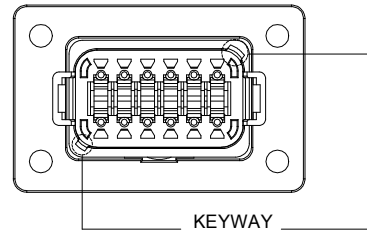

KEYWAY  
(2)PLACES

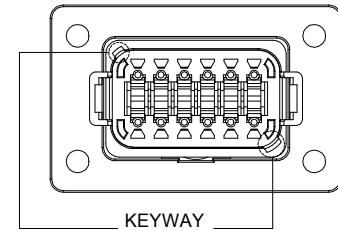

KEYWAY  
(2)PLACES

KEY-A CONFIGURATION	
COLOR	PART NUMBER
GREY	AT04-12PA-L012

KEY-B CONFIGURATION	
COLOR	PART NUMBER
BLACK	AT04-12PB-L012

KEY-C CONFIGURATION	
COLOR	PART NUMBER
GREEN	AT04-12PC-L012

KEY-D CONFIGURATION	
COLOR	PART NUMBER
BROWN	AT04-12PD-L012

SEE SHEET 2	DESCRIPTION	ITEM
PART NUMBER		

QUANTITY	MATERIALS LIST			SIGNATURES		DATE
	UNLESS OTHERWISE SPECIFIED			DRAWN:	ROOKIE	30NOV/18
	1) All dimensions are in metric(mm).			CHECKED:	ORION	30NOV/18
	2) Tolerances are as follows:			ENGINEER:		
	1 PL DEC ±0.30			APPROVAL:	TOMMY	30NOV/18
	2 PL DEC ±0.15			CUSTOMER:		
	3 PL DEC ±0.08			THIS DRAWING IS SUPPLIED FOR INFORMATION ONLY. DESIGN FEATURES, SPECIFICATIONS AND PERFORMANCE DATA SHOWN HEREON ARE THE PROPERTY OF THE AMPHENOL CORPORATION. NO RIGHTS OF REPRODUCTION ARE IMPLIED. ALL DIMENSIONS ARE SUBJECT TO NORMAL MANUFACTURING VARIATIONS.		
	3) Note reference =			SCALE: NONE		
MATERIAL SPECIFICATIONS:				DWG NO: AT04-12PX-L012		
PROCESS SPECIFICATIONS:				REVISION: A1		
NEXT ASSY:				SHEET 2 OF 3		

TITLE: 12P RECEPTACLE FLANGE MOUNT  
DWG NO: AT04-12PX-L012  
REV: A1  
SH: 2  
OF: 3

**Amphenol**

Sine Systems - www.amphenol-sine.com  
44724 Morley Drive  
Clinton Township, MI 48036

12P RECEPTACLE, FLANGE MOUNT

REVISIONS					
REV	ECO	DESCRIPTION	DATE	BY	APPR
A1	-	RELEASE NUMBER	30/NOV/18	ROOKIE	TOMMY

FOR REFERENCE ONLY

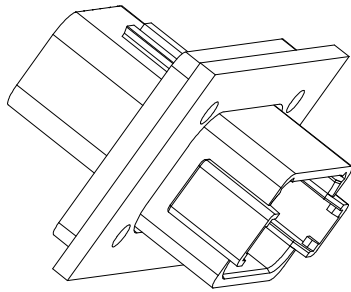

FRONT MOUNT

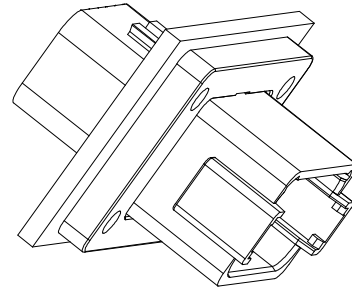

REAR MOUNT

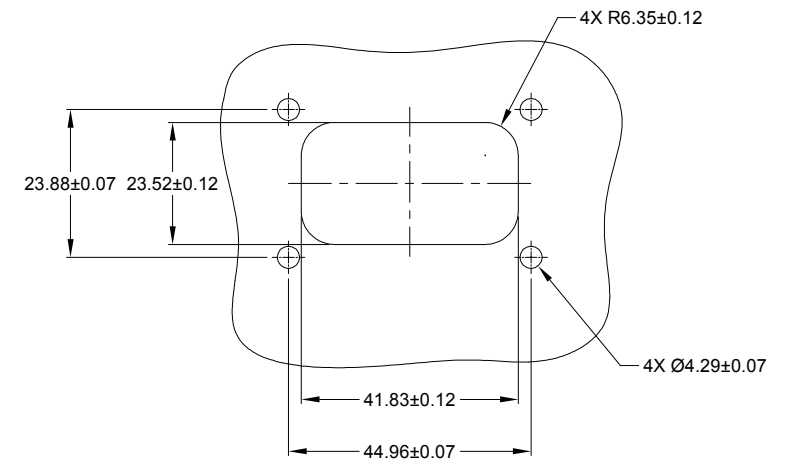



RECOMMENDED CUTOUT  
FRONT AND REAR MOUNT



SEE SHEET 2		DESCRIPTION		ITEM
PART NUMBER				
QUANTITY				
MATERIALS LIST				
<b>UNLESS OTHERWISE SPECIFIED</b> 1) All dimensions are in metric(mm). 2) Tolerances are as follows: 1 PL DEC ±0.30 Fractions ±1/64 2 PL DEC ±0.15 Angles ±1° 3 PL DEC ±0.08 3) Note reference =		<b>SIGNATURES</b> <b>DATE</b> DRAWN: ROOKIE    30/NOV/18 CHECKED: ORION    30/NOV/18 ENGINEER: APPROVAL: TOMMY    30/NOV/18		
MATERIAL SPECIFICATIONS:		 Sine Systems - www.amphenol-sine.com 44724 Morley Drive Clinton Township, MI 48036		
PROCESS SPECIFICATIONS:		CUSTOMER: THIS DRAWING IS SUPPLIED FOR INFORMATION ONLY. DESIGN FEATURES, SPECIFICATIONS AND PERFORMANCE DATA SHOWN HEREON ARE THE PROPERTY OF THE AMPHENOL CORPORATION. NO RIGHTS OF REPRODUCTION ARE IMPLIED. ALL DIMENSIONS ARE SUBJECT TO NORMAL MANUFACTURING VARIATIONS.		
NEXT ASSY:		SIZE: <b>B C-</b> SCALE: NONE	TYPE: DWG NO: <b>AT04-12PX-L012</b>	REVISION: <b>A1</b> SHEET 3 OF 3

TITLE: 12P RECEPTACLE, FLANGE MOUNT  
DWG NO.: AT04-12PX-L012  
REV: A1  
SH: 3  
OF: 3



# AT Series™ - Contact Size 16 Options

Machined Contacts, Sockets & Pins				
Part Number	Description	Size	AWG	Type
AT60-215-1631	Male Contact - Pin, Gold-plated	16	14	Machined
AT62-209-1631	Female Contact - Socket, Gold-plated	16	14	Machined
AT60-215-16141	Male Contact - Pin, Nickel-plated	16	14	Machined
AT62-209-16141	Female Contact - Socket, Nickel-plated	16	14	Machined
AT60-202-1631	Male Contact - Pin, Gold-plated	16	16-20	Machined
AT62-201-1631	Female Contact - Socket, Gold-plated	16	16-20	Machined
AT60-202-16141	Male Contact - Pin, Nickel-plated	16	16-20	Machined
AT62-201-16141	Female Contact - Socket, Nickel-plated	16	16-20	Machined
AT60-202-1631-22	Male Contact - Pin, Gold-plated	16	22-24	Machined
AT62-201-1631-22	Female Contact - Socket, Gold-plated	16	22-24	Machined
AT60-202-16141-22	Male Contact - Pin, Nickel-plated	16	22-24	Machined
AT62-201-16141-22	Female Contact - Socket, Nickel-plated	16	22-24	Machined

Tooling - Machined Contacts		
Part	Part Number	Description
	CA-5D12	Universal Hand Crimp Tool, Size 12/16/20 (Machined contacts only)
	CA-5E12	Pneumatic Crimp Tool, Size 12/16/20 (Machined contacts only)

Contact Removal Tools		
Part	Part Number	Description
	ATRT-100	Used for removal of contacts for A Series™ products
	AT11-310-1605	Contact Removal Tool, Plastic, Size 16
	A114017	Sealing Plug, Size 16, White

Stamped & Formed Contacts, Sockets & Pins				
Part Number	Description	Size	AWG	Type
AT60-14-0144	Male Contact - Pin, Gold-plated	16	14-16	Stamped & Formed
AT62-14-0144	Female Contact - Socket, Gold-plated	16	14-16	Stamped & Formed
AT60-14-0122	Male Contact - Pin, Nickel-plated	16	14-16	Stamped & Formed
AT62-14-0122	Female Contact - Socket, Nickel-plated	16	14-16	Stamped & Formed
AT60-16-0144	Male Contact - Pin, Gold-plated	16	16-18	Stamped & Formed
AT62-16-0144	Female Contact - Socket, Gold-plated	16	16-18	Stamped & Formed
AT60-16-0122	Male Contact - Pin, Nickel-plated	16	16-18	Stamped & Formed
AT62-16-0122	Female Contact - Socket, Nickel-plated	16	16-18	Stamped & Formed
AT60-16-0644	Male Contact - Pin, Gold-plated	16	18-20	Stamped & Formed
AT62-16-0644	Female Contact - Socket, Gold-plated	16	18-20	Stamped & Formed
AT60-16-0622	Male Contact - Pin, Nickel-plated	16	18-20	Stamped & Formed
AT62-16-0622	Female Contact - Socket, Nickel-plated	16	18-20	Stamped & Formed
AT60-16-0844	Male Contact - Pin, Gold-plated	16	20-22	Stamped & Formed
AT62-16-0844	Female Contact - Socket, Gold-plated	16	20-22	Stamped & Formed
AT60-16-0822	Male Contact - Pin, Nickel-plated	16	20-22	Stamped & Formed
AT62-16-0822	Female Contact - Socket, Nickel-plated	16	20-22	Stamped & Formed

Tooling - Stamped & Formed Contacts		
Part	Part Number	Description
	MFX-3950	Crimp Die - Size 16, 18-20AWG (S&F contacts only)
	MFX-3953	Crimp Die - Size 16, 16-18AWG (S&F contacts only)
	MFX-3975	Crimp Die - Size 16, 14-16AWG (S&F contacts only)
	MFX-3990	Crimp Die - Size 16, 20-22AWG (S&F contacts only)
	ATT-16-00	Hand Crimp Tool - Size 16, 14-16AWG (S&F contacts only)
	ATT-16-01	Hand Crimp Tool - Size 16, 18-20AWG (S&F contacts only)
	ATT-1612-03	Hand Crimp Tool - Size 16, 20-22AWG (S&F contacts only)

**Amphenol Sine Systems**  
 44724 Morley Drive  
 Clinton Township, MI 48036 USA  
[www.amphenol-sine.com](http://www.amphenol-sine.com)  
 09/2021