

SPECIFICATIONS SDSA39R2W

MECHANICAL DIMENSIONS

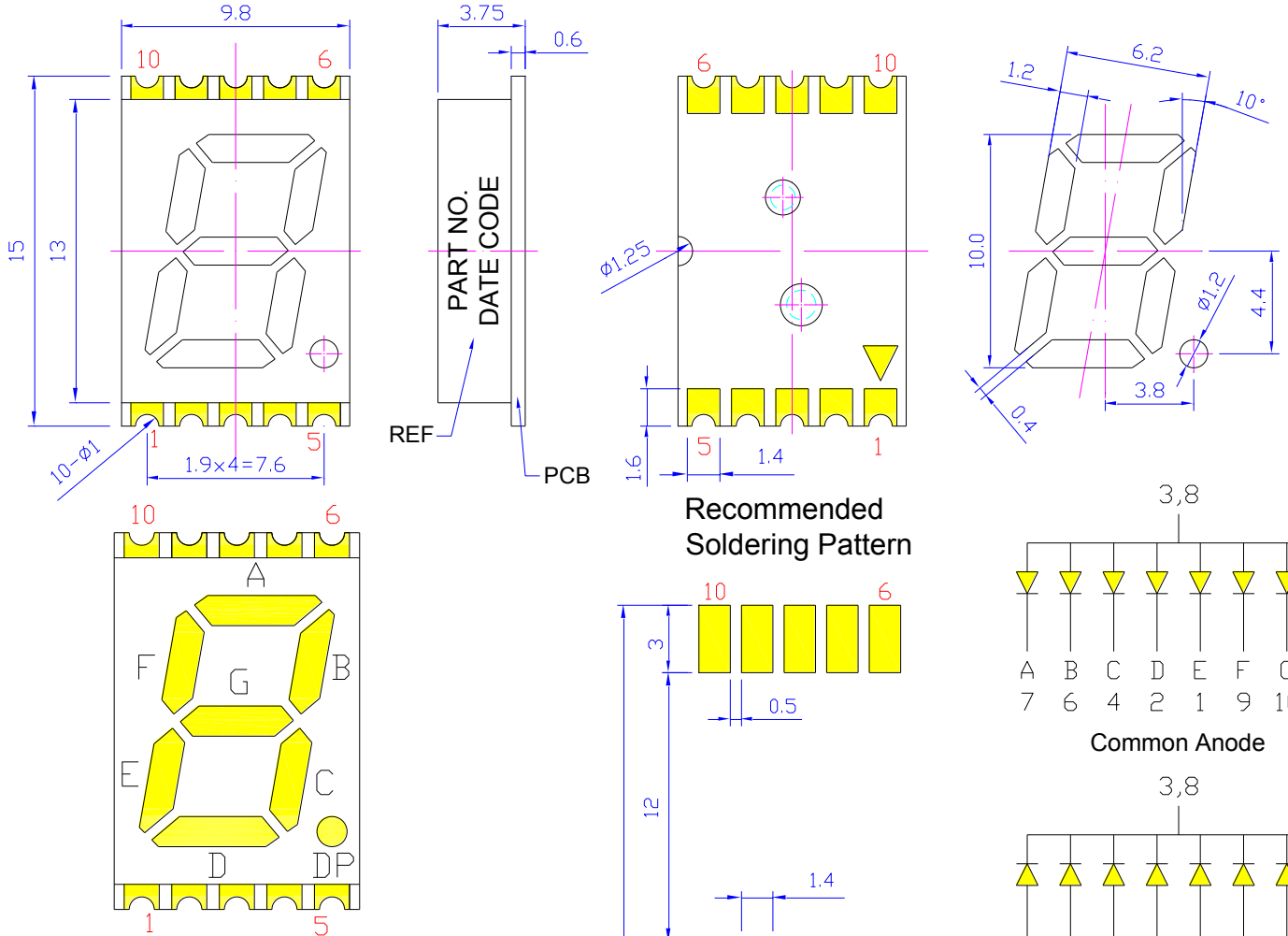

- Notes:**
1. All dimensions are in millimeters (inches).
 2. Tolerance is $\pm 0.25\text{mm}$ (0.01") unless otherwise noted.
 3. Specifications are subject to change without notice.

| Part Number | Chip Material | Color of Emission | Lens Type | Description |
|-------------|---------------|-------------------|---------------|--------------|
| SDSA39R2W | InGaAlP | Red | White Segment | Common Anode |



ChromeLED Corp. reserves the right to make changes at any time in order to supply the best product possible. The most current version of this document will always be available at: www.chromeled.com

ABSOLUTE MAXIMUM RATINGS
(TA=25°C)

| Parameter | Symbol | Value | Unit |
|---|------------------|----------|---------|
| Power Dissipation per Dice | P _{AD} | 70 | mW |
| Derating Liner from 25°C per Dice | - | 0.33 | mA / °C |
| Continuous Forward Current per Dice | I _{AF} | 25 | mA |
| Peak Current per Dice (duty cycle 1/10, 1kHz) | I _{PF} | 90 | mA |
| Reverse Voltage per Dice | V _R | 5 | V |
| Operating Temperature | T _{OPR} | -40~+105 | °C |
| Storage Temperature | T _{STG} | -40~+105 | °C |

OPTICAL-ELECTRICAL CHARACTERISTICS
(TA=25°C)

| Characteristic | Symbol | Condition | Value | | | Unit |
|---------------------------------------|----------------|-----------------------|-------|-------|------|------|
| | | | Min. | Type. | Max. | |
| Forward Voltage per Dice | V _F | I _F = 20mA | - | 2.0 | 2.4 | V |
| Reverse Current per Dice | I _R | V _R = 5V | - | - | 10 | μA |
| Peak Wavelength per Dice | λ _P | I _F = 20mA | - | 632 | - | nm |
| Dominant Wavelength per Dice | λ _D | I _F = 20mA | 619 | 624 | 629 | nm |
| Luminous Intensity per Dice | I _V | I _F = 20mA | - | 40 | - | mcd |
| Spectral Radiation Bandwidth per Dice | Δλ | I _F = 20mA | - | 20 | - | nm |

*Tolerance of viewing angle: -10 / +5 deg.



ChromeLED Corp. reserves the right to make changes at any time in order to supply the best product possible. The most current version of this document will always be available at: www.chromeled.com

OPTICAL CHARACTERISTIC CURVES

Typical Electro-optical Characteristic Curves (25 °C Free Air Temperature Unless Otherwise Specified)

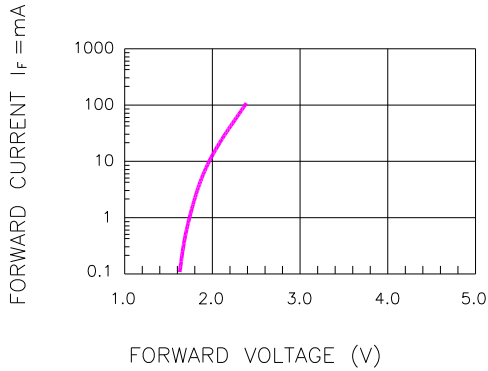

Fig.1 FORWARD CURRENT VS. FORWARD VOLTAGE

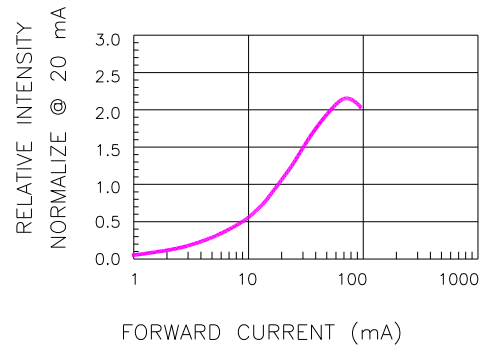

Fig.2 RELATIVE INTENSITY VS. FORWARD CURRENT

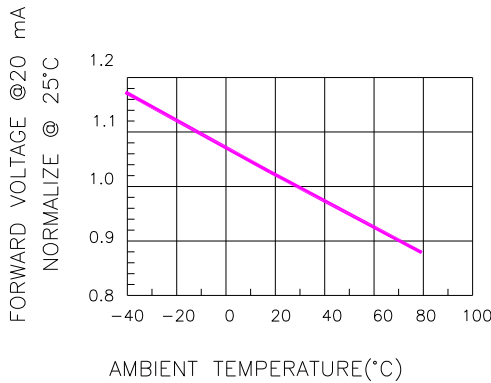

Fig.3 FORWARD VOLTAGE VS. TEMPERATURE

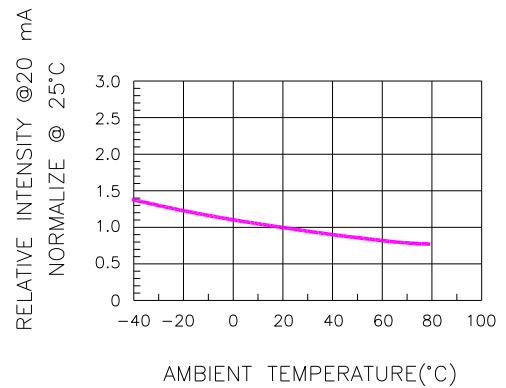

Fig.4 RELATIVE INTENSITY VS. TEMPERATURE

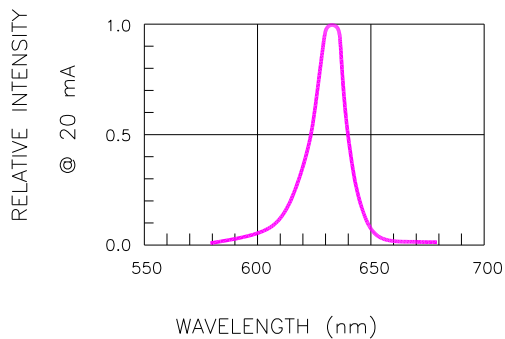

Fig.5 RELATIVE INTENSITY VS. WAVELENGTH

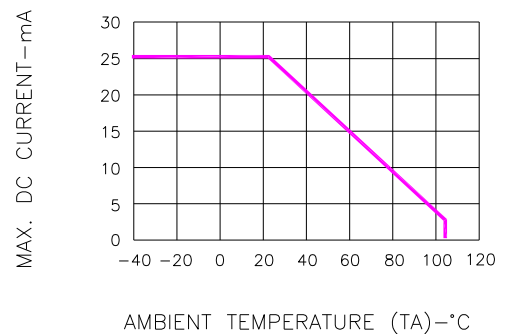

Fig.6 MAX. ALLOWABLE DC CURRENT VS. AMBIENT TEMPERATURE



ChromeLED Corp. reserves the right to make changes at any time in order to supply the best product possible. The most current version of this document will always be available at: www.chromeled.com

SOLDERING CONDITIONS – LAMP TYPE LED

● **SMT REFLOW SOLDERING INSTRUCTIONS**

SMT Soldering Profile
 Pb free reflow soldering Profile



● **SOLDERING IRON**

Basic spec is ≤ 4 sec when 260°C. If temperature is higher, time should be shorter (+10°C→1 sec). Power dissipation of Iron should be smaller than 15W, and temperature should be controllable. Surface temperature of the device should be under 230°C.

● **REWORK**

- Customer must finish rework within 5 sec. under 260°C.
- The head of soldering iron cannot touch copper foil.



ChromeLED Corp. reserves the right to make changes at any time in order to supply the best product possible. The most current version of this document will always be available at: www.chromeled.com

DIMENSIONS OF TAPE (Unit: mm)

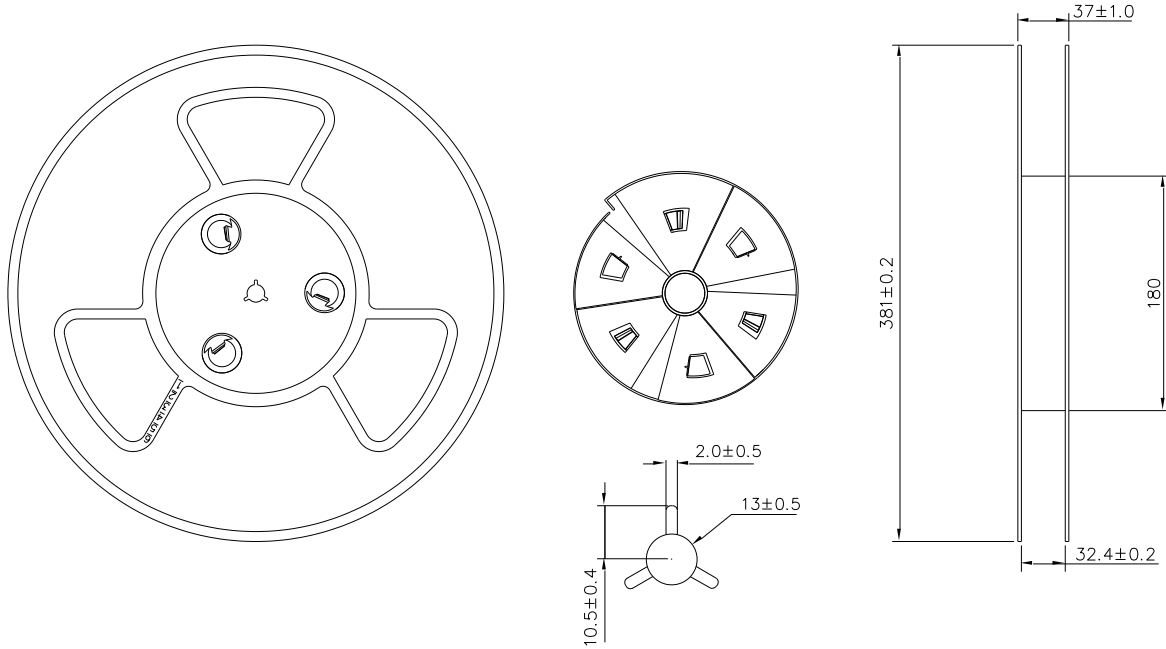

PACKAGING SPECIFICATION

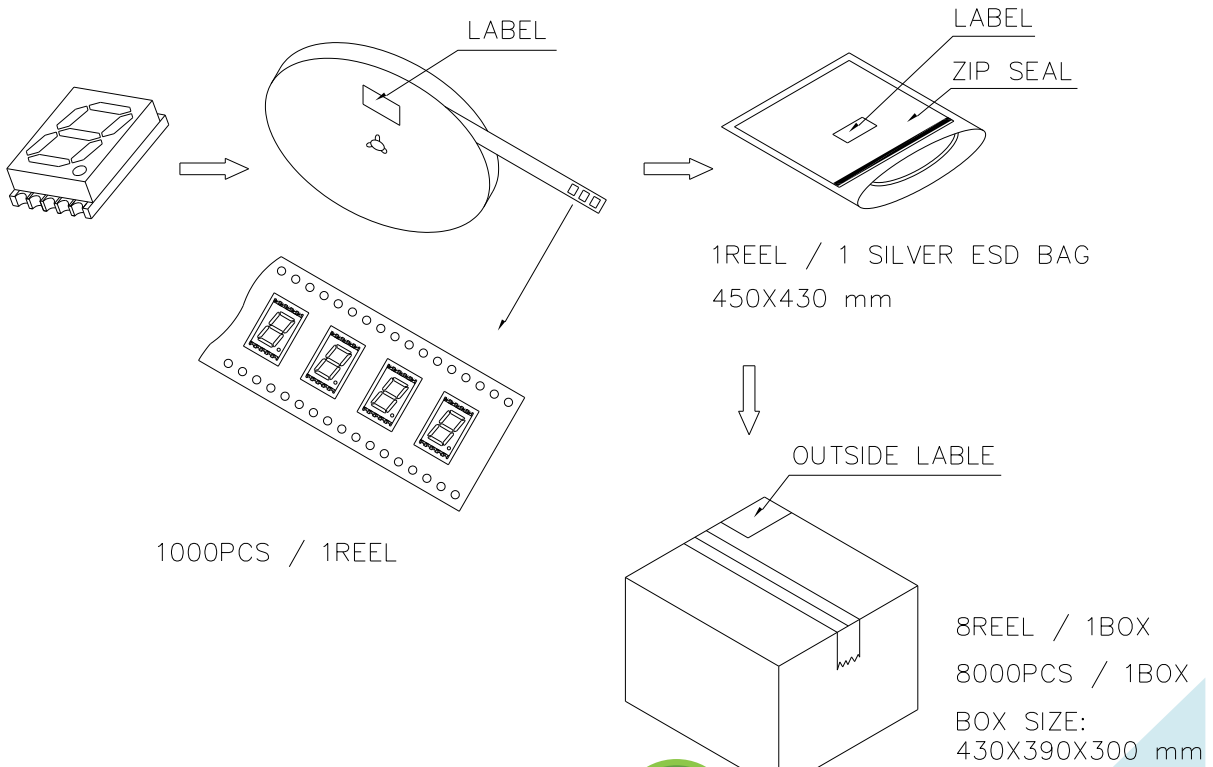

ChromeLED Corp. reserves the right to make changes at any time in order to supply the best product possible. The most current version of this document will always be available at: www.chromeled.com