

ECN/PCN No.: 4110

For Manufacturer			
Product Description: PLASTIC SMD MEMS OSCILLATOR	Abracon Part Number / Part Series: ASTMK	<input type="checkbox"/> Documentation only <input type="checkbox"/> ECN <input checked="" type="checkbox"/> EOL	<input checked="" type="checkbox"/> Series <input type="checkbox"/> Part Number
Affected Revision: A	New Revision: EOL	Application:	<input type="checkbox"/> Safety <input checked="" type="checkbox"/> Non-Safety
Prior to Change: Active https://abracon.com/Oscillators/ASTMK.pdf			
After Change: EOL			
Cause/Reason for Change: Discontinuation of manufacturing capability.			
Change Plan			
Effective Date: 2/7/2022	Additional Remarks: N/A		
Change Declaration: N/A			
Issued Date: 2/7/2022	Issued By: <i>Brooke Cushman Product Engineer</i>	Issued Department: Engineering	
Approval: <i>Thomas Culhane Engineering Director</i>	Approval: <i>Reuben Quintanilla Quality Director</i>	Approval: <i>Ying Huang Purchasing Director</i>	
For Abracon EOL only			
Last Time Buy (if applicable): 5/7/2022	Alternate Part Number / Part Series: none		
Additional Approval:	Additional Approval:	Additional Approval:	
Customer Approval (If Applicable)			
Qualification Status: <input type="checkbox"/> Approved <input type="checkbox"/> Not accepted <i>Note: It is considered approved if there is no feedback from the customer 1 month after ECN/PCN is released.</i>			
Customer Part Number:		Customer Project:	
Company Name:	Company Representative:	Representative Signature:	
Customer Remarks:			

Ultra-miniature, Low Power, 32.768kHz MEMS Oscillator



SMD: 2.0 x 1.2 x 0.60mm
CSP: 1.54 x 0.84 x 0.60mm

ASTMK



RoHS/RoHS II compliant

Moisture Sensitivity Level (MSL) – 1

FEATURES:

- Factory programmable output frequency: 1Hz to 32.768kHz
- Available in two types of ultra-miniature packages:
2.0 x 1.2 x 0.6mm (SMD); 1.54 x 0.84 x 0.6mm (CSP)
- Supply Voltage: 1.2V to 3.63V (-10 ~ +70°C); 1.5V to 3.63V (-40 ~ +85°C)
- Ultra-Low Current Consumption: 1.4µA max. (core current, no load)
- Frequency Stabilities include:
 - ±75ppm over -10 to +70°C, ±100ppm over -40 to +85°C
- Internal power supply filtering eliminates external bypass capacitor for V_{dd} port.
- Proprietary NanoDrive™ Technology enables programmable output swing for lower power

APPLICATIONS:

- Timekeeping
- Battery Management
- Mobile devices
- RTC reference clock
- Wireless accessories
- Fitness/Medical monitoring sensors
- Sport video cams

STANDARD SPECIFICATIONS:

Parameters	Min	Typ	Max	Unit	Notes
Output Frequency Range (F _{out})	1		32768	Hz	Factory programmed between 1Hz and 32.768kHz, in the powers of 2
Initial Frequency Tolerance (F _{tol}) ⁽¹⁾⁽⁵⁾	-20		+20	ppm	T _A = +25°C, post reflow, V _{dd} :1.5-3.63V
Frequency Stability over Temperature (F _{stab}) ⁽²⁾	-75		+75	ppm	T _A = -10°C to +70°C, V _{dd} :1.5-3.63V
	-100		+100		T _A = -40°C to +85°C, V _{dd} :1.5-3.63V
	-250		+250		T _A = -10°C to +70°C, V _{dd} :1.2-1.5V
Aging (@+25°C)	-1		+1	ppm	First year
Supply Voltage (V _{dd})	1.2		3.63	V	T _A = -10°C to +70°C
	1.5		3.63		T _A = -40°C to +85°C
Core Operating Current (I _{dd}) ⁽³⁾		0.90		µA	T _A = +25°C, V _{dd} : 1.8V. No load.
			1.3		T _A = -10°C to +70°C, V _{dd} max: 3.63V. No load
			1.4		T _A = -40°C to +85°C, V _{dd} max: 3.63V. No load.
Output Stage Operating Current (I _{dd out}) ⁽³⁾		0.065	0.125	µA/V _{pp}	T _A = -40°C to +85°C, V _{dd} max: 1.5-3.63V. No load.
Power Supply Ramp (t _{Vdd Ramp})			100	ms	T _A = -40°C to +85°C, 0 to 90%*V _{dd}
Start-up Time (T _{start}) ⁽⁴⁾			300+1 period	ms	T _A = +25°C±10°C, valid output
			500+1 period		T _A = -40°C to +85°C, valid output
Operating Temperature Range (T _{use})	-10		+70	°C	Option "M"
	-40		+85		Option "L"
Period Jitter		35		ns _{RMS}	Cycles=10000, T _A = +25°C, V _{dd} :1.5-3.63V
LVC MOS Output Option (T _A = -40°C to +85°C. Typical values are at T _A = +25°C)					
Output Rise/Fall Time (t _r /t _f)		100	200	ns	10-90%(V _{dd}), 15pF load, V _{dd} :1.5-3.63V
Output Clock Duty Cycle	48		52	%	
Output Voltage	V _{OH}	90%*V _{dd}		V	V _{dd} :1.5-3.63V. I _{OH} = -10µA, 15pF
	V _{OL}		10%*V _{dd}		V _{dd} :1.5-3.63V. I _{OL} = 10µA, 15pF
NanoDrive™(6) Programmable, Reduced Swing Output Option					
Output Rise/Fall Time (t _r /t _f)			200	ns	30-70%(V _{OL} / V _{OH}), 10pF load
Output Clock Duty Cycle	48		52	%	
AC-coupled Programmable Output Swing (V _{sw})		0.20 to 0.80		V	ASTMK does not internally AC-couple. This output description is intended for a receiver that is AC-coupled. See Part Identification section for available AC-coupled signal swing options. V _{dd} :1.5-3.63V. 10pF load, I _{OH} / I _{OL} =±0.2µA

Ultra-miniature, Low Power, 32.768kHz MEMS Oscillator



SMD: 2.0 x 1.2 x 0.60mm
CSP: 1.54 x 0.84 x 0.60mm

ASTMK



RoHS/RoHS II compliant

(Continued)

Parameters	Min	Typ	Max	Unit	Notes
DC-biased Programmable Output Voltage High Range (V_{OH})		0.60 to 1.225		V	V_{dd} : 1.5-3.63V. I_{OH} = -0.2 μ A. 10pF load. See Part Identification section for available V_{OH} / V_{OL} levels.
DC-biased Programmable Output Voltage Low Range (V_{OL})		0.35 to 0.80		V	V_{dd} : 1.5-3.63V. I_{OL} = 0.2 μ A. 10pF load. See Part Identification section for available V_{OH} / V_{OL} levels.
Programmable Output Voltage Swing Tolerance	-0.055		+0.055	V	T_A = -40°C to +85°C, V_{dd} : 1.5-3.63V

Note:

1. Measured peak-to-peak. Tested with Agilent 53132A frequency counter. Due to the low operating frequency, the gate time must be ≥ 100 ms to ensure an accurate frequency measurement.
2. Stability is specified for two operating voltage ranges. Stability progressively degrades with supply voltage below 1.5V. Measured peak-to-peak. Inclusive of initial tolerance at +25°C, and variations over operating temperature, rated power supply voltage and load.
3. Core operating current does not include output driver operating current or load current. To derive total operating current (no load), add core operating current + output driver operating current, where output driver operating current = $C_{driver} * V_{out} * F_{out}$.
4. Measured from the time V_{dd} reaches 1.5V.
5. Board-level underfill (BLUF) is not recommended for 1508 CSP package as it will cause a shift in the frequency tolerance.
6. NanoDrive™ is a SiTime trademark.

Absolute Maximum Ratings

Attempted operation outside the absolute maximum ratings may cause permanent damage to the part. Actual performance of the IC is only guaranteed within the operational specifications, not at absolute maximum ratings.

Parameters	Test Condition	Value	Unit
Continuous Power Supply Voltage Range (V_{dd})		-0.5 to 3.63	V
Short Duration Max. Power Supply Voltage (V_{dd})	≤ 30 minutes	4.0	V
Continuous Maximum Operating Temperature Range	V_{dd} : 1.5-3.63V	105	°C
Short Duration Max. Operating Temperature Range	V_{dd} : 1.5-3.63V, ≤ 30 minutes	125	°C
Human Body Model (HBM) ESD Protection	JESD22-A114	3000	V
Charge-Device Model (CDM) ESD Protection	JESD22-C101	750	V
Machine Model (MM) ESD Protection	JESD22-A115	300	V
Latch-up Tolerance	JESD78 Compliant		
Mechanical Shock Resistance	Mil 883, Method 2002	10000	g
Mechanical Vibration Resistance	Mil 883, Method 2007	70	g
2012 SMD Junction Temperature		150	°C
1508 CSP Junction Temperature		150	°C
Storage Temperature		-65 to +150	°C

Ultra-miniature, Low Power, 32.768kHz MEMS Oscillator



SMD: 2.0 x 1.2 x 0.60mm
CSP: 1.54 x 0.84 x 0.60mm

ASTMK

RoHS/RoHS II compliant

Block Diagram

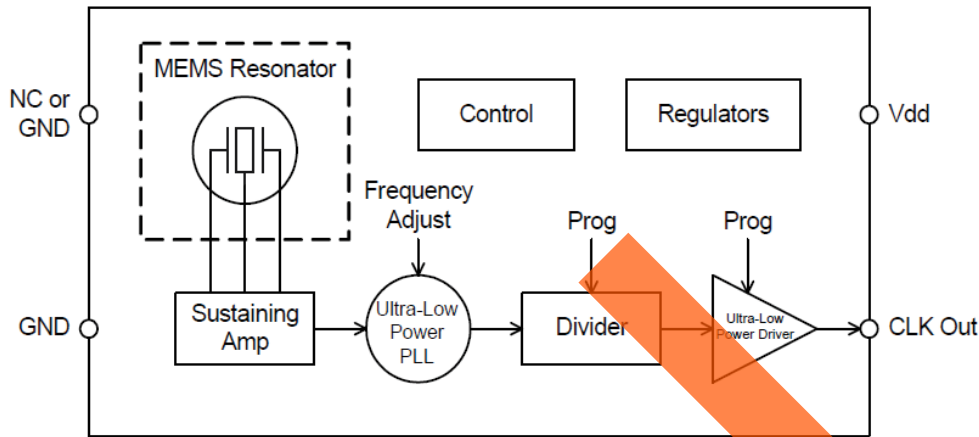

PART IDENTIFICATION:

ASTMK - kHz - - - -

Output Frequency (kHz)
32.768
16.384
8.192
4.096
2.048
1.024
0.512
0.256
0.128
0.064
0.032
0.016
0.008
0.004
0.002
0.001

Operating Temp.
M: -10°C ~ +70°C
L: -40°C ~ +85°C

Freq. Stability
P: ±75ppm (-10°C ~ +70°C only)
Q: ±100 ppm (-40°C ~ +85°C only)

Package Type
J: CSP (1.5 x 0.8mm)
H: SMD (2.0 x 1.2mm)

Packaging
Blank: Bulk
T3: Tape & Reel (3kpcs / reel)
T10: Tape & Reel (10kpcs / reel)

Output Level Option
DCC: Rail-to-Rail LVCMOS
AA3: AC-coupled signal, swing level: 0.3V min.
D14: DC-coupled signal, V _{OL} : 0.400V max, V _{OH} : 1.100V min
D26: DC-coupled signal, V _{OL} : 0.525V max, V _{OH} : 1.225V min

Ultra-miniature, Low Power, 32.768kHz MEMS Oscillator



SMD: 2.0 x 1.2 x 0.60mm
CSP: 1.54 x 0.84 x 0.60mm

ASTMK



RoHS/RoHS II compliant

Typical Performance Data (TA=25°C, Vdd=1.8V, unless otherwise stated)

Initial Tolerance Histogram

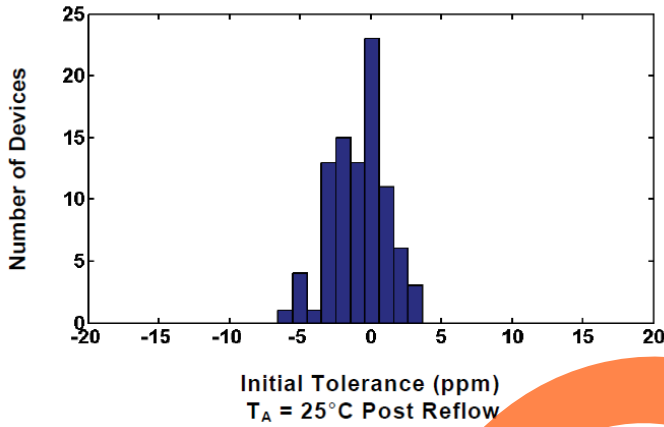

Frequency Stability vs. Operating Temperature Range

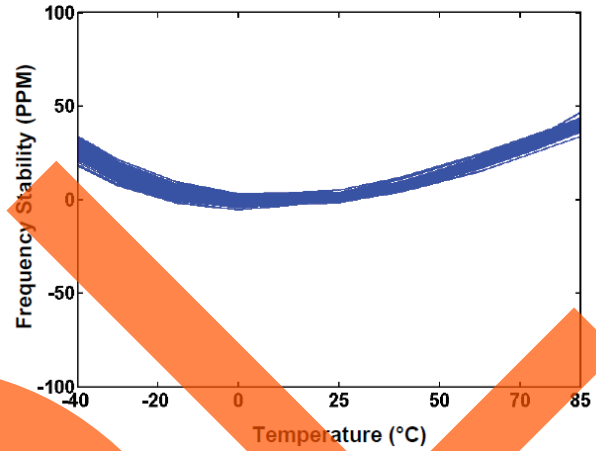

Core Current vs Operating Temperature Range

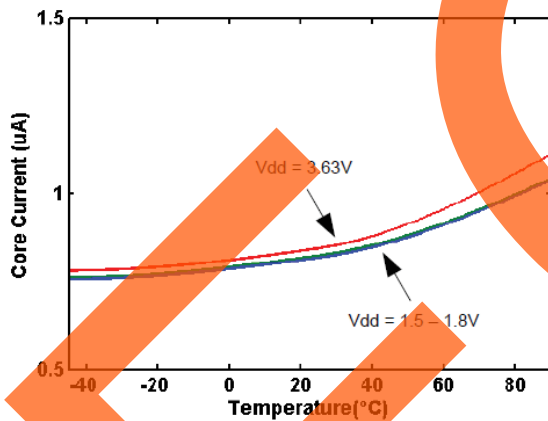

Output Stage Current vs Operating Temperature Range

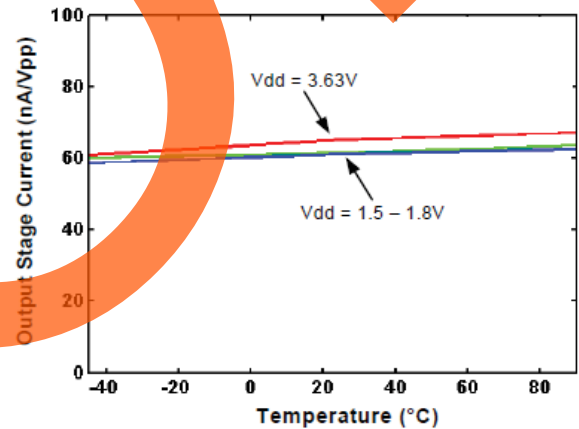

32.768kHz Start-up Time

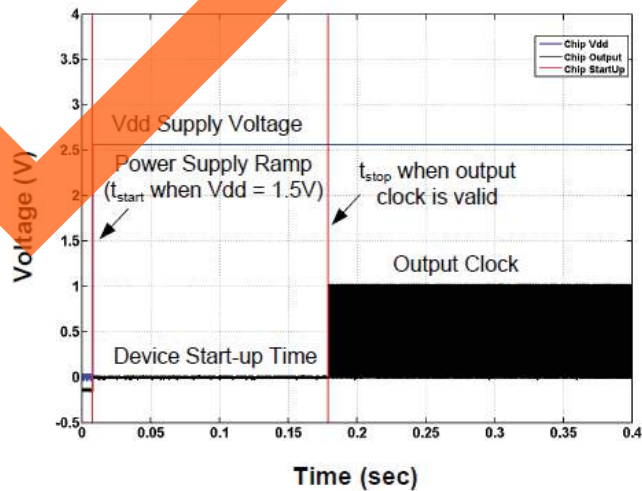

Ultra-miniature, Low Power, 32.768kHz MEMS Oscillator



SMD: 2.0 x 1.2 x 0.60mm
CSP: 1.54 x 0.84 x 0.60mm

ASTMK



RoHS/RoHS II compliant

Typical Performance Data (TA=25°C, Vdd=1.8V, unless otherwise stated)---(Continued)

Power Supply Noise Rejection ($\pm 150\text{mV}$ Noise)

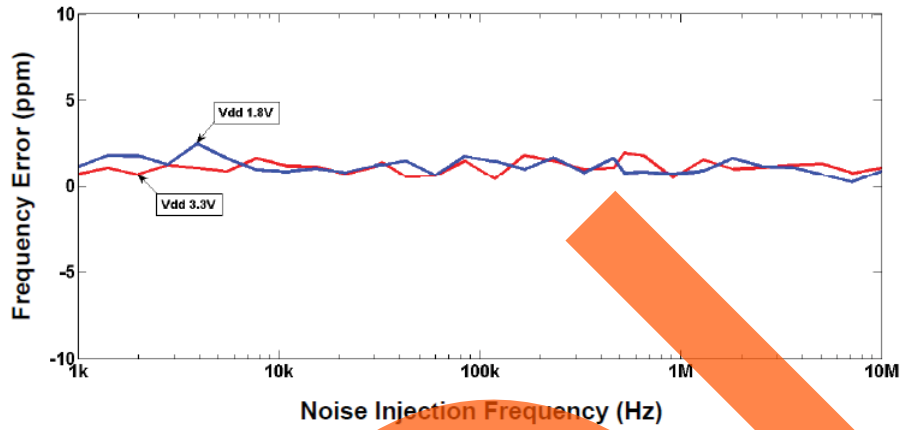

NanoDrive™ Output Waveform ($V_{OH} = 1.1\text{V}$, $V_{OL} = 0.4\text{V}$)

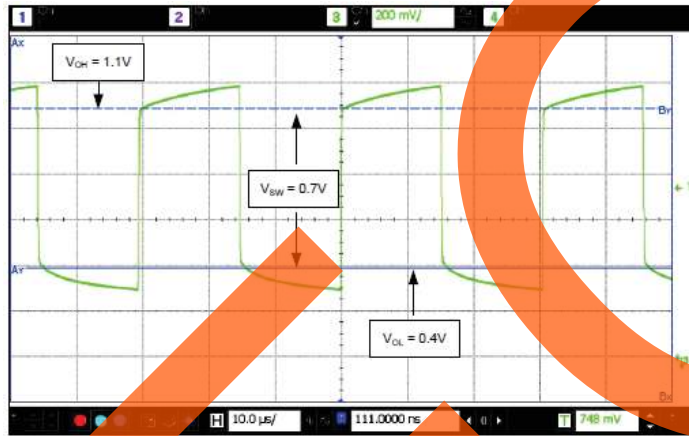

LVC MOS Output Waveform ($V_{\text{swing}} = 1.8\text{V}$)

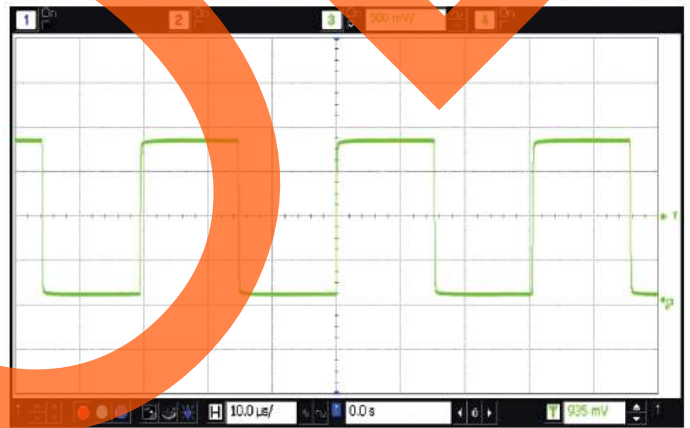

REFLOW PROFILE:

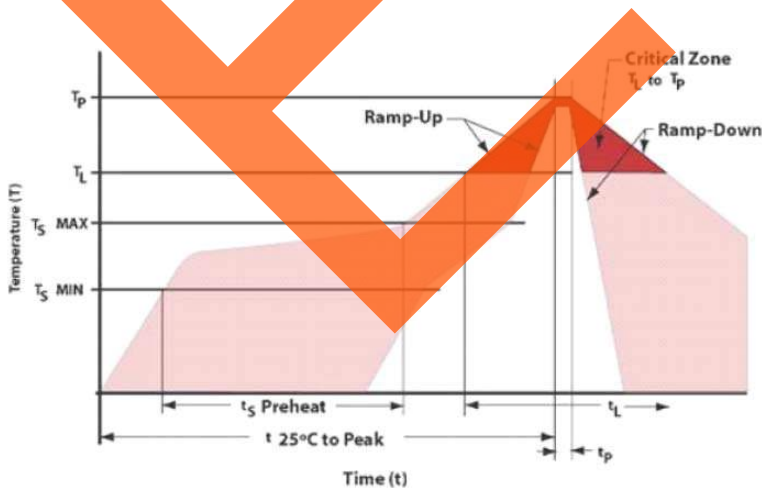

Item	Conditions
T_S MAX to T_L (Ramp-up Rate)	3°C/second max
Preheat	
Temperature Minimum (T_S MIN)	150°C
Temperature Typical (T_S TYP)	175°C
Temperature Maximum (T_S MAX)	200°C
Time (t_s)	60 – 180 seconds
Ramp-up Rate (T_L to T_P)	3°C/second max
Time Maintained Above	
Temperature (T_L)	217°C
Time (t_L)	60 – 150 seconds
Peak Temperature (T_P)	260°C max
Target Peak Temperature (T_P Target)	255°C
Time within 5°C of actual peak (t_p)	20 – 40 seconds
Max. Number of Reflow Cycles	3
Ramp-down Rate	6°C/second max
Time 25°C to Peak Temperature (t)	8 minutes max

Ultra-miniature, Low Power, 32.768kHz MEMS Oscillator



SMD: 2.0 x 1.2 x 0.60mm
CSP: 1.54 x 0.84 x 0.60mm

ASTMK



RoHS/RoHS II compliant

OUTLINE DIMENSION:

2012 SMD package:

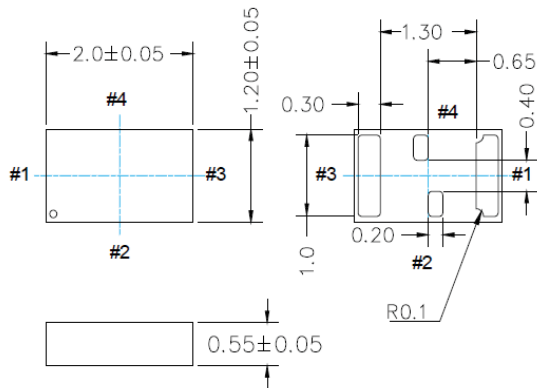

Recommended Land Pattern

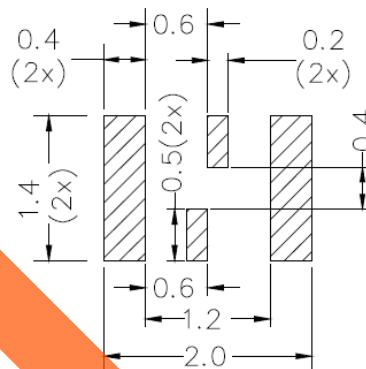

Pin	Name	I/O	Functionality
1	NC	No Connect	No connection. Will not respond to any input signal.
2	GND	Power Supply Ground	Connect to ground. All GND pins must be connected to power supply ground.
3	CLK Out	OUT	Oscillator clock output.
4	V _{dd}	Power Supply	Connect to power supply 1.5V ≤ V _{dd} ≤ 3.63V for operation over -40°C to +85°C temperature range. Under normal operating conditions, V _{dd} doesn't require external bypass/decoupling capacitor(s). Internal power supply filtering will reject more than ±150mVpp with frequency components through 10MHz.

1508 CSP package:

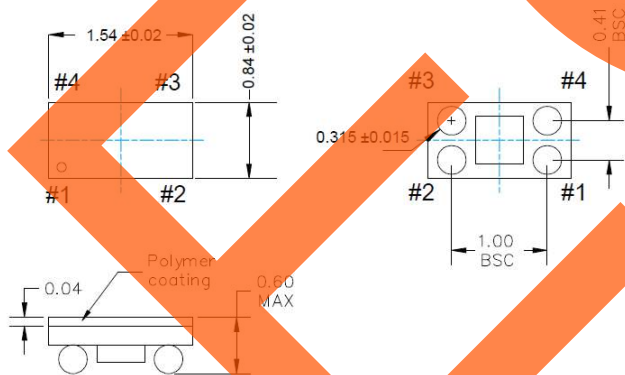

Recommended Land Pattern

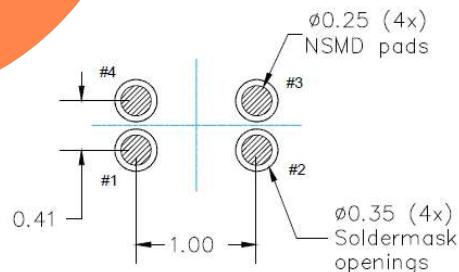

(soldermask openings shown with heavy dashed line)

Recommend 4-mil (0.1mm) stencil thickness

Pin	Name	I/O	Functionality
1,4	GND	Power Supply Ground	Connect to ground. Acceptable to connect pin 1 and 4 together. Both pins must be connected to GND.
2	CLK Out	OUT	Oscillator clock output.
3	V _{dd}	Power Supply	Connect to power supply 1.2V ≤ V _{dd} ≤ 3.63V. Under normal operating conditions, V _{dd} doesn't require external bypass/decoupling capacitor(s). Internal power supply filtering will reject more than ±150mVpp with frequency components through 10MHz.

Dimensions: mm

Ultra-miniature, Low Power, 32.768kHz MEMS Oscillator



SMD: 2.0 x 1.2 x 0.60mm
CSP: 1.54 x 0.84 x 0.60mm

ASTMK



RoHS/RoHS II compliant

TAPE & REEL:

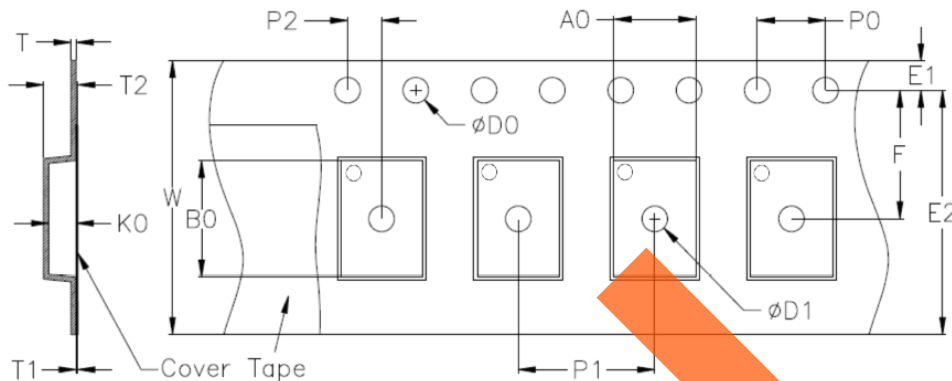

Tape Dimensions for 2012 SMD package (Unit: mm)

D0	D1 min.	E1	E2 min.	F	P0	P1	P2
1.55±0.05	1.0	1.75±0.1	6.05	3.5±0.05	4.0±0.1	4.0±0.1	2.0±0.05
T	T1 max.	T2 max.	W max.	A0	B0	K0	
0.25±0.05	NA	NA	8.3	1.6±0.05	2.25±0.10	0.65±0.05	

Tape Dimensions for 1508 CSP package (Unit:mm)

D0	D1 min.	E1	E2 min.	F	P0	P1	P2
1.55±0.05	0.18	1.75±0.1	6.05	3.5±0.05	4.0±0.1	4.0±0.1	2.0±0.05
T	T1 max.	T2 max.	W max.	A0	B0	K0	
0.20±0.02	NA	NA	8.3	0.96±0.03	1.66±0.03	0.63±0.03	

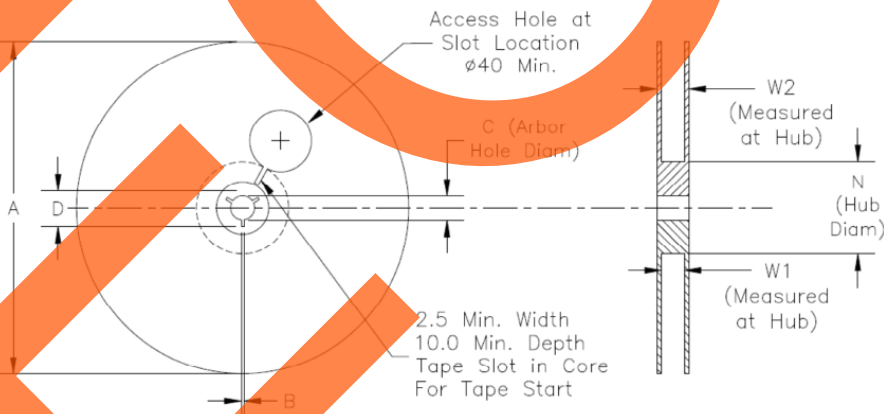

Option	A max.	B min.	C	D min.	N	W1	W2 max.
T3	180.5	1.5	13.0+0.6/-0.2	20.2	60±0.5	8.4+1.5/-0	14.4
T10	330	1.5	13.0±0.2	20.2	100±0.5	8.4+1.5/-0	14.4

T3= Tape and reel (3,000pcs/reel)
T10= Tape and reel (10,000pcs/reel)

Unit: mm

ATTENTION: Abracon LLC's products are COTS – Commercial-Off-The-Shelf products; suitable for Commercial, Industrial and, where designated, Automotive Applications. Abracon's products are not specifically designed for Military, Aviation, Aerospace, Life-dependent Medical applications or any application requiring high reliability where component failure could result in loss of life and/or property. For applications requiring high reliability and/or presenting an extreme operating environment, written consent and authorization from Abracon LLC is required. Please contact Abracon LLC for more information.