



SPECIFICATION SHEET

SPECIFICATION SHEET NO.	N1116- SOT232907AS02F
DATE	Nov. 16, 2021
REVISION	A1
DESCRIPTION	<p>SMD Plastic-Encapsulate Transistors, SOT-23 series, 3 pads</p> <p>MMBT2907A Type, PNP</p> <p>Collector Power Dissipation 250mW. Collector Current -600mA Max.</p> <p>Operating Temp. Range -55°C ~+150°C,</p> <p>Package in Tape/Reel, 3000pcs/Reel</p> <p>RoHS/RoHS III compliant</p>
CUSTOMER	
CUSTOMER PART NUMBER	
CROSS REF. PART NUMBER	
ORIGINAL PART NUMBER	MDD MMBT2907A
PART CODE	SOT232907AS02F

VENDOR APPROVE		
Issued/Checked/Approved		
		
DATE: Nov 16, 2021		

CUSTOMER APPROVE
DATE:

11/16/2021

SMD PLASTIC-ENCAPULATE TRANSISTORS SOT23 SERIES

MAIN FEATURE

- Epitaxial planar die construction
- Complementary NPN Type (P/N. MMBT2222A)
- Collector Power Dissipation 250mW
- Collector Current -600mA.



APPLICATION

- For printed circuit board

RFQ

[Request For Quotation](#)

PART CODE GUIDE

SOT23	2907A	S	02F
1	2	3	4

- 1) **SOT23**: SMD Plastic-Encapsulate Transistors, 3 pads SOT-23 series Code
- 2) **2907A**: Type code for MMBT2907A
- 3) **S**: Package code, Package in Tape/Reel, 3000pcs/Reel
- 4) **02F**: Marking code for “2F” on the case surface, Different Marking for different specification.

SMD PLASTIC-ENCAPULATE TRANSISTORS SOT23 SERIES

DIMENSION (Unit: Inch/mm)

Image for reference

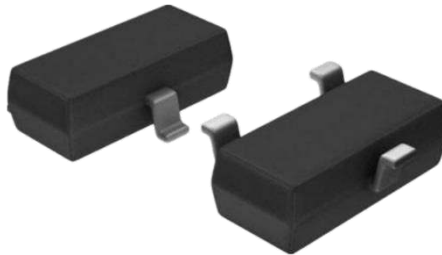

Marking: 2F

SOT-23

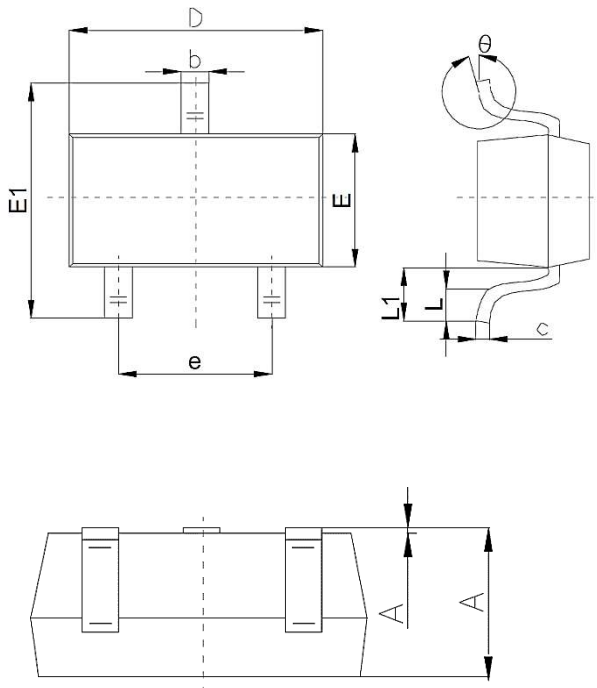

Symbol	Value (mm)		
	Min.	Typ.	Max.
A	1.0		1.4
A1			0.10
b	0.35		0.50
c	0.10		0.20
D	2.70	2.90	3.10
E	1.40		1.60
E1	2.40		2.80
e		1.9	
L	0.10		0.30
L1	0.40		
θ	0°		10°

Recommend Pad Layout

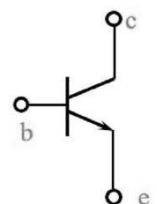
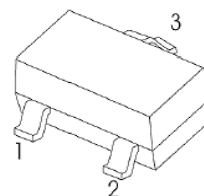
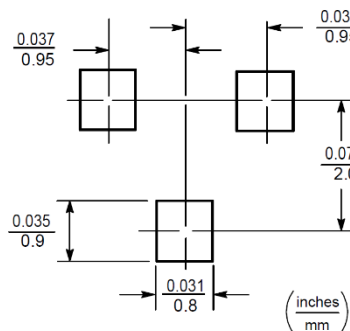

- 1.Base
- 2.Emitter
- 3.Collector

SMD PLASTIC-ENCAPULATE TRANSISTORS SOT23 SERIES
MECHANICAL DATA

Case	Terminals	Polarity	Mounting Position	Weight per piece
JEDEC SOT-23 molded plastic body	Solder plated, Solderable per MIL-STD-750, Method 2026	Polarity symbol marking on case	Any	0.00019 Ounce, 0.00591 grams

MAX. RATINGS AT Ta=25 °C

Parameter	SYMBOLS	VALUE	UNITS
		LIMIT	
Collector-Base Voltage	V _{CBO}	-60	Volts
Collector-Emitter Voltage	V _{CEO}	-60	Volts
Emitter-Base Voltage	V _{EBO}	-5	Volts
Collector Current	I _C	-600	mA
Collector Power Dissipation	P _C	250	mW
Thermal Resistance Junction to Ambient	R _{QJA}	500	°C/W
Junction temperature	T _J	+150	°C
Storage temperature range	T _{STG}	-55 ~ +150	°C

SMD PLASTIC-ENCCAPULATE TRANSISTORS SOT23 SERIES
ELECTRICAL CHARACTERISTICS AT Ta= 25 °C

Parameter	SYMBOLS	VALUE			UNIT	Condition
		Min.	Typ.	Max.		
Collector-base breakdown voltage	$V_{(BR)CBO}$	-60			V	$I_C = -10\mu A, I_E = 0$
Collector-emitter breakdown voltage	$V_{(BR)CEO}^*$	-60			V	$I_C = -10mA, I_B = 0$
Emitter-base breakdown voltage	$V_{(BR)EBO}$	-5			V	$I_E = -10\mu A, I_C = 0$
Collector cut-off current	I_{CBO}			-20	nA	$V_{CB} = -50V, I_E = 0$
Base cut-off current	I_{EBO}			-10	nA	$V_{EB} = -3V, I_C = 0$
Collector cut-off current	I_{CEX}			-50	nA	$V_{EB} = -30V,$ $V_{BE(off)} = -0.5V$
DC Current gain	$h_{FE(1)}^*$	100		300		$V_{CE} = -10V, I_C = -150mA$
	$h_{FE(2)}$	75				$V_{CE} = -10V, I_C = -0.1mA$
	$h_{FE(3)}^*$	100				$V_{CE} = -10V, I_C = -1mA$
	$h_{FE(4)}$	100				$V_{CE} = -10V, I_C = -10mA$
	$h_{FE(5)}^*$	75				$V_{CE} = -10V, I_C = -1500mA$
Collector-emitter saturation voltage	$V_{CE(sat)}^*$			-0.4	V	$I_C = -150mA, I_B = -5mA$ $I_C = -500mA, I_B = -15mA$
				-1.6		
Base-emitter saturation voltage	$V_{BE(sat)}^*$			-1.3	V	$I_C = -150mA, I_B = -15mA$ $I_C = -500mA, I_B = -50mA$
				-2.6		
Transition frequency	f_T	200			MHz	$V_{CE} = -20V, I_C = -50mA,$ $f = 100MHz$
Delay time	t_d			10	ns	$V_{CE} = -30V$ $I_C = -150mA, I_B = -15mA$
Rise time	t_r			25	ns	
Storage time	t_s			225	ns	$V_{CE} = -6V, I_C = -150mA$ $I_{B1} = -I_{B2} = -15mA$
Fall time	t_f			60	ns	

Note: * pulse test: Pulse Width $\leq 300\mu s$, Duty Cycle $\leq 2.0\%$.

SMD PLASTIC-ENCCAPULATE TRANSISTORS SOT23 SERIES
RELIABILITY

Number	Experiment Items	Experiment Method And Conditions	Reference Documents
1	Solder Resistance Test	Test 260°C± 5°C for 10 ± 2 sec. Immerse body into solder 1/16" ± 1/32"	MIL-STD-750D METHOD-2031.2
2	Solderability Test	230°C ±5°C for 5 sec.	MIL-STD-750D METHOD-2026.1 0
3	Pull Test	1 kg in axial lead direction for 10 sec.	MIL-STD-750D METHOD-2036.4
4	Bend Test	0.5Kg Weight Applied To Each Lead, Bending Arcs 90 °C ± 5 °C For 3 Times	MIL-STD-750D METHOD-2036.4
5	High Temperature Reverse Bias Test	TA=100°C for 1000 Hours at VR=80% Rated VR	MIL-STD-750D METHOD-1038.4
6	Forward Operation Life Test	TA=25°C Rated Average Rectified Current	MIL-STD-750D METHOD-1027.3
7	Intermittent Operation Life Test	On state: 5 min with rated IRMS Power Off state: 5 min with Cool Forced Air. On and off for 1000 cycles.	MIL-STD-750D METHOD-1036.3
8	Pressure Cooker Test	15 PSIG, TA=121°C, 4 hours	MIL-S-19500 APPENOIXC
9	Temperature Cycling Test	-55°C~+125°C; 30 Minutes For Dwelled Time 5 minutes for transferred time. Total: 10 cycles.	MIL-STD-750D METHOD-1051.7
10	Thermal Shock Test	0°C for 5 minutes., 100°C for 5minutes, Total: 10 cycles	MIL-STD-750D METHOD-1056.7
11	Forward Surge Test	8.3ms Single Sale Sine-wave One Surge.	MIL-STD-750D METHOD-4066.4
12	Humidity Test	TA=65°C, RH=98% for 1000 hours.	MIL-STD-750D METHOD-1021.3
13	High Temperature Storage life Test	150°C for 1000 Hours	MIL-STD-750D METHOD-1031.5

SMD PLASTIC-ENCAPULATE TRANSISTORS SOT23 SERIES

SUGGESTED REFLOW PROFILE (For Reference Only)

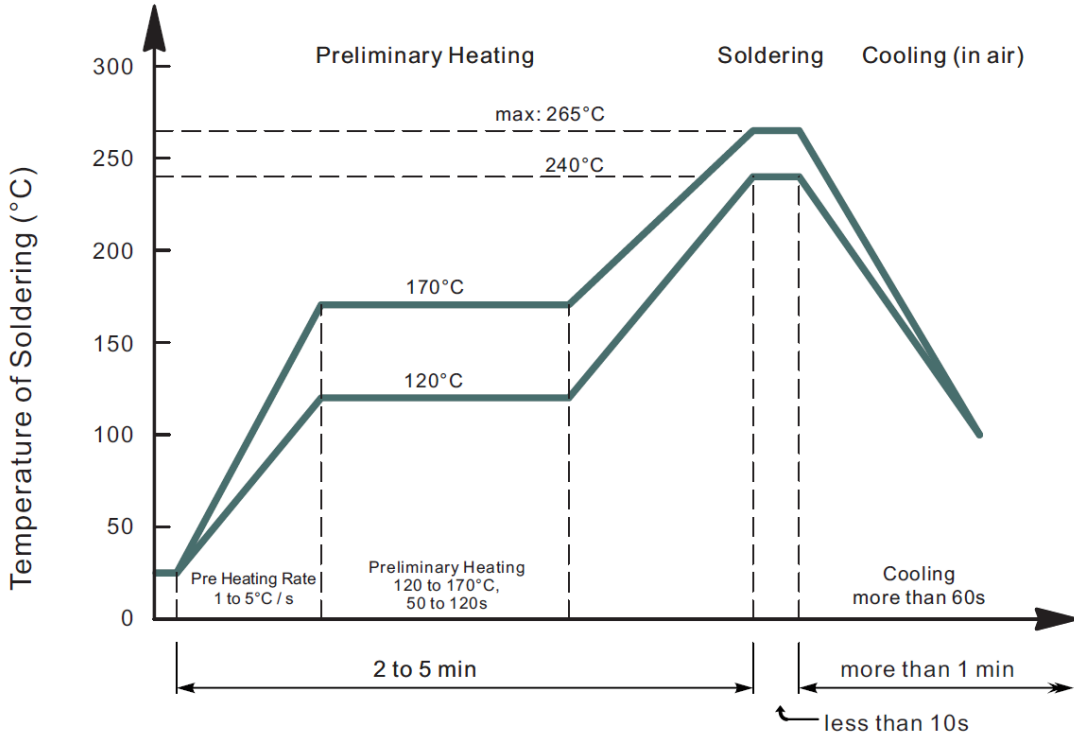

- Recommended peak temperature is over 245°C, If peak temperature is below 245 °C, you may adjust the following parameters; time length of peak temperature (longer), time length of soldering (longer), thickness of solder paste (thicker)
- Welding shall not exceed 2 times
- Remark: lead free solder paste (96.5 sn/3.0 Ag/0.5Cu)

SMD PLASTIC-ENCCAPULATE TRANSISTORS SOT23 SERIES

RATINGS AND CHARACTERISTIC CURVES (For Reference Only)

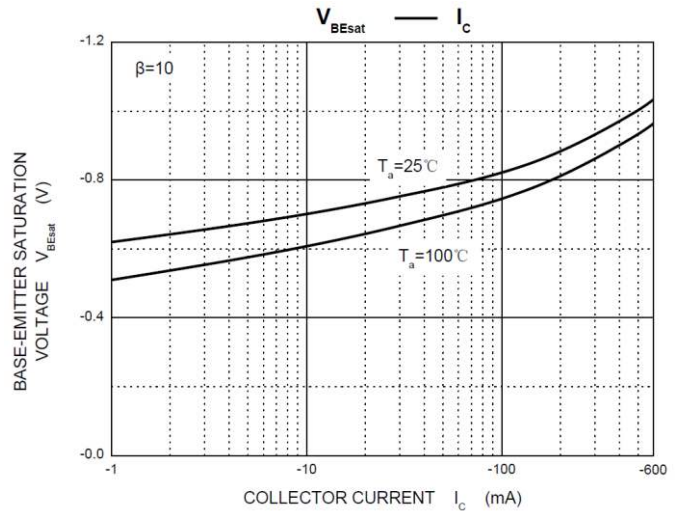
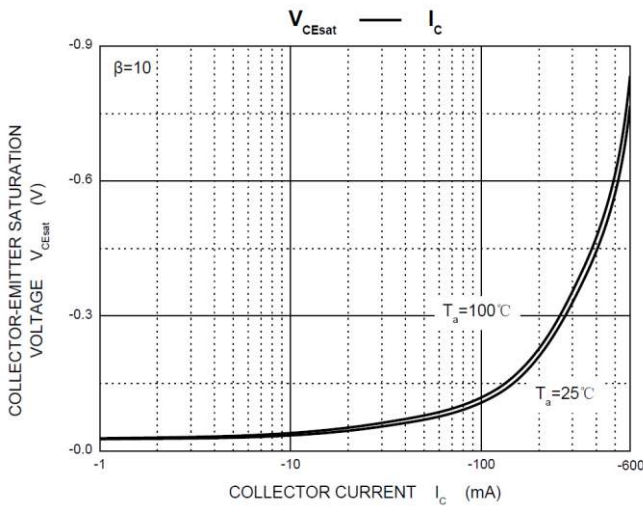
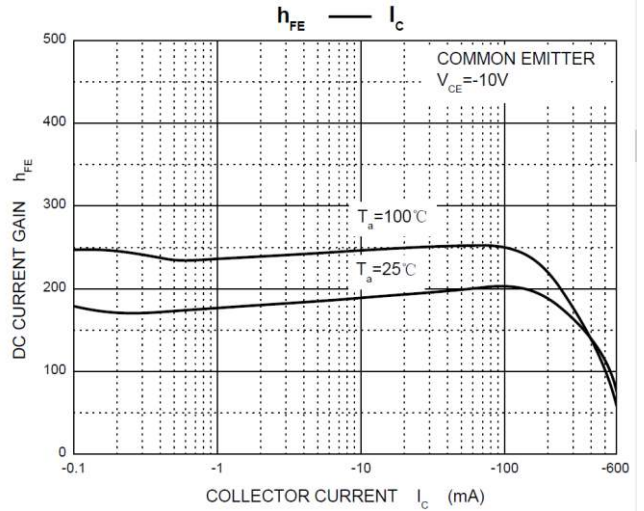
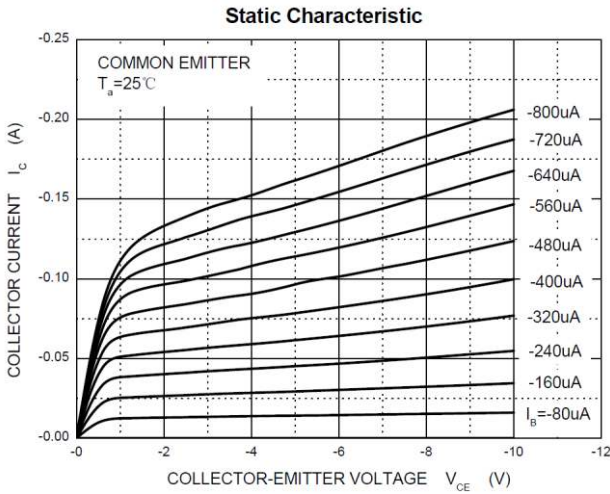

SMD PLASTIC-ENCAPULATE TRANSISTORS SOT23 SERIES

RATINGS AND CHARACTERISTIC CURVES (For Reference Only)

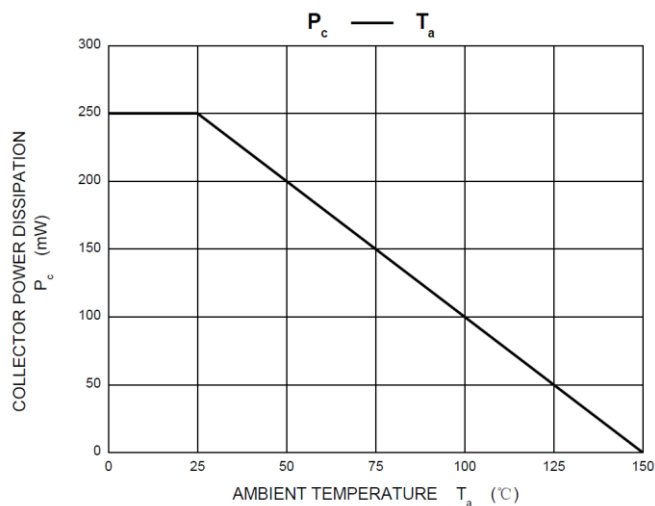
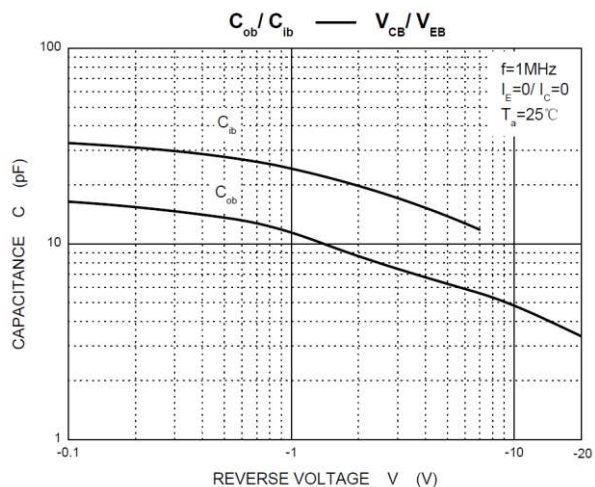
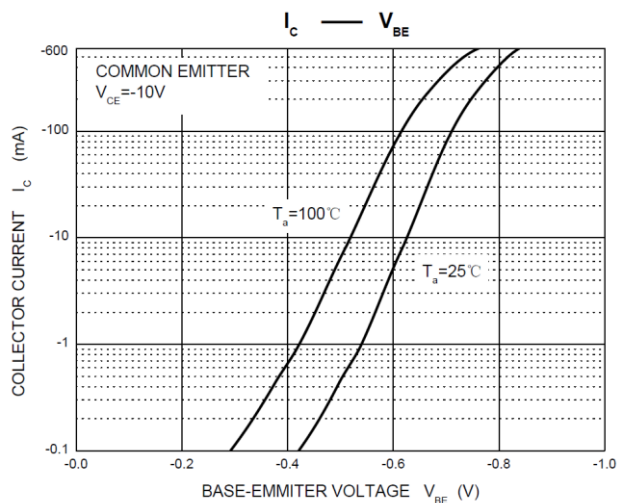

SMD PLASTIC-ENCAPULATE TRANSISTORS SOT23 SERIES
TAPE/REEL (Unit: mm)

All Devices are packed in accordance with EIA standard RS-481-A and specifications.

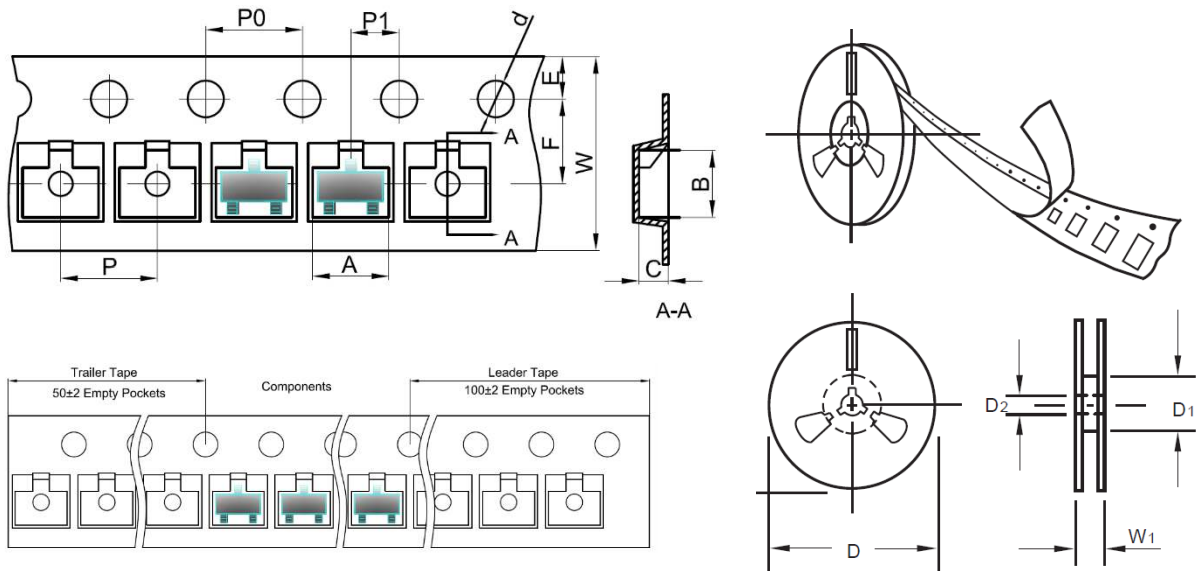

Item	Symbol	Tolerance	SOT-23
Carrier width	A	0.1	3.15
Carrier Length	B	0.1	2.77
Carrier Depth	C	0.1	1.22
Sprocket hole	d	0.05	1.55
7"Reel outside diameter	D	2.0	178.00
7"Reel inner diameter	D1	Min.	54.4
Feed hole diameter	D2	0.5	13.00
Sprocket hole position	E	0.1	1.75
Punch hole position	F	0.1	3.50
Punch hole pitch	P	0.1	4.00
Sprocket hole pitch	P0	0.1	4.00
Embossment center	P1	0.1	2.00
Overall tape thickness	T	0.1	0.25
Tape width	W	0.3	8.00
Reel width	W1	1.0	19.50

SMD PLASTIC-ENCAPULATE TRANSISTORS SOT23 SERIES

PACKAGE

Case Code	SOT-23
Reel Size	7"
Reel Size	178 mm
MPQ/Reel	3000 pcs
Qty. /Box	6000 pcs
G.W/Box	1 LBS

DISCLAIMER

NextGen Component, Inc. reserves the right to make changes to the product(s) and or information contained herein without notice. No liability is assumed as a result of their use or application. No rights under any patent accompany the sale of any such product(s) or information