

## Mechanical Dimensions: Inches [mm]

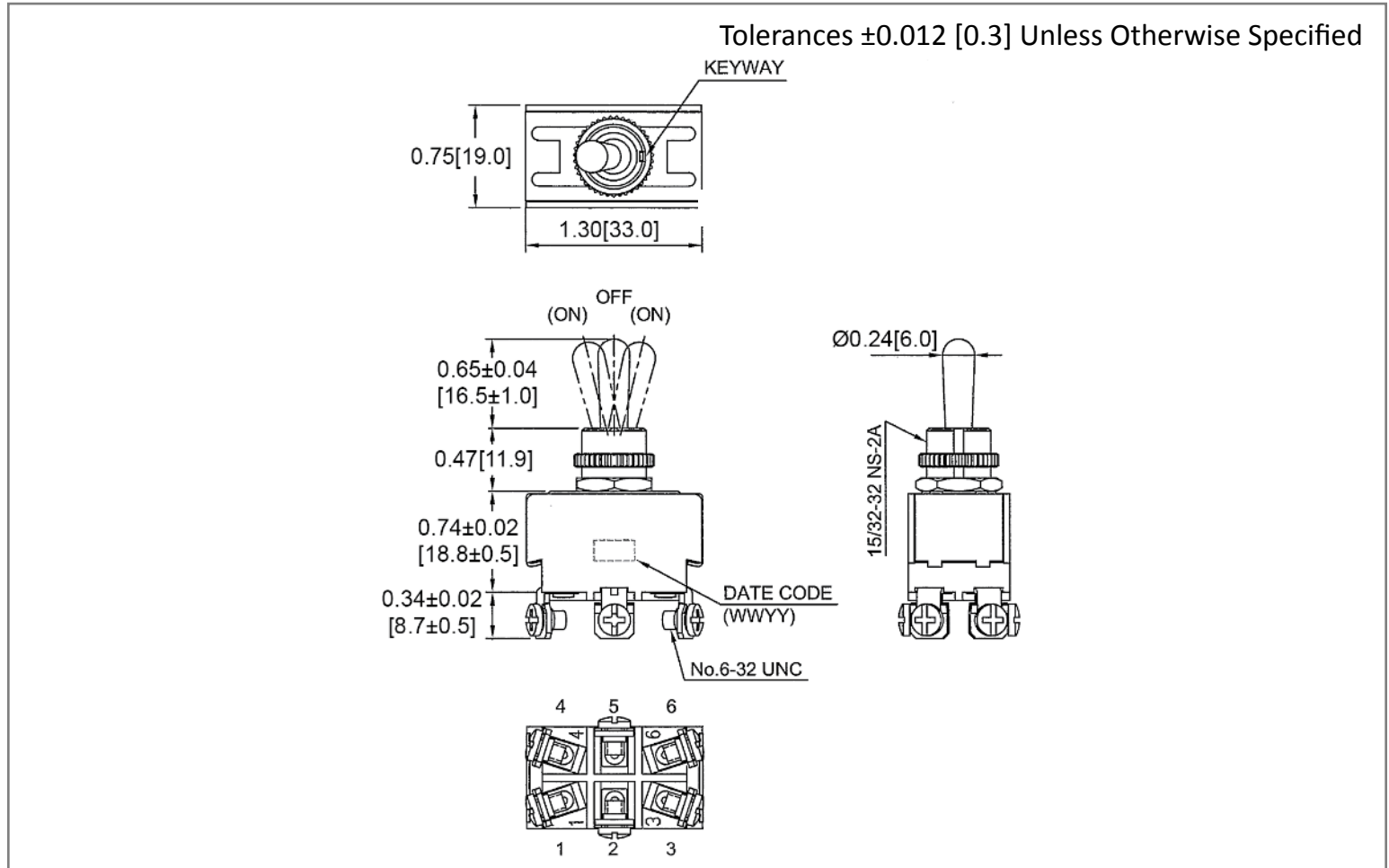

## Mounting Hole

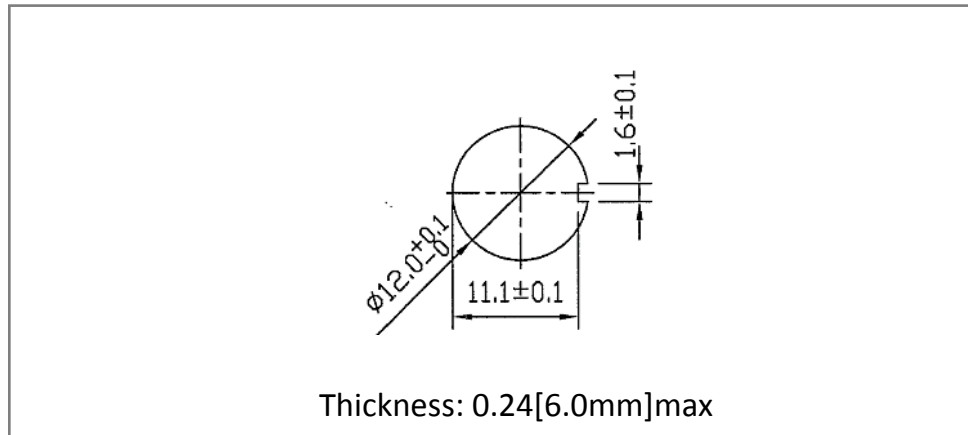

## Circuit Diagram

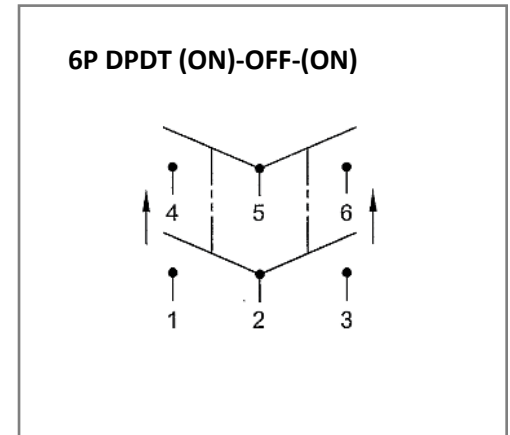

## Electrical Specifications

<b>Rating</b>	20A 125V AC, 10A 277V AC, 1 1/2HP 125-250V AC 10(4)A 125/250V AC
<b>Contact Resistance</b>	50m ohm Max
<b>Insulation Resistance</b>	DC 500V 100M ohm Min
<b>Dielectric Strength</b>	AC 1500V 1 minute
<b>Operation Temperature</b>	1800gf±400gf

## Material Specifications

1 Hex Nut Assy
1 Knurl Nut Assy

Rev	Date of issue	Revision Notes	Designed	Approved
B	11-30-2021	Initial Drawing	RC	OF