

## Rail-to-rail 1.8 V high-speed comparator

SOT23-5/SC70-5

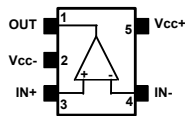

Pin connections (top view)



### Features

- Propagation delay: 38 ns
- Low current consumption: 73  $\mu$ A
- Rail-to-rail inputs
- Push-pull outputs
- Supply operation from 1.8 to 5 V
- Wide temperature range: -40 °C to 125 °C
- High ESD tolerance: 5 kV HBM, 300 V MM
- SMD packages
- Automotive qualification

### Applications

- Telecom
- Instrumentation
- Signal conditioning
- High-speed sampling systems
- Portable communication systems

#### Maturity status link

[TS3021, TS3021A](#)

#### Related products

TS3022	For a dual comparator with similar performances
TS3011	For a high-speed comparator

### Description

The **TS3021, TS3021A** single comparator features high-speed response time with rail-to-rail inputs. With a supply voltage specified from 2 to 5 V, this comparator can operate over a wide temperature range: -40 °C to 125 °C.

The **TS3021, TS3021A** comparator offers micropower consumption as low as a few tens of microamperes thus providing an excellent ratio of power consumption current versus response time.

The **TS3021, TS3021A** includes push-pull outputs and is available in small packages (SOT23-5 and SC70-5).

# 1 Absolute maximum ratings and operating conditions

**Table 1. Absolute maximum ratings (AMR)**

Symbol	Parameter	Value	Unit	
$V_{CC}$	Supply voltage, $V_{CC} = (V_{CC+}) - (V_{CC-})^{(1)}$	5.5	V	
$V_{ID}$	Differential input voltage <sup>(2)</sup>	±5		
$V_{IN}$	Input voltage range	$(V_{CC-}) - 0.3$ to $(V_{CC+}) + 0.3$		
$R_{thja}$	Thermal resistance junction-to-ambient <sup>(3)</sup>	SOT23-5	250	°C/W
		SC70-5	205	
$R_{thjc}$	Thermal resistance junction-to-case <sup>(3)</sup>	SOT23-5	81	
		SC70-5	172	
$T_{stg}$	Storage temperature	-65 to 150	°C	
$T_j$	Junction temperature	150		
$T_{LEAD}$	Lead temperature (soldering 10 s)	260		
ESD	HBM: human body model <sup>(4)</sup>	5000	V	
	MM: machine model <sup>(5)</sup>	300		
	CDM: charged device model <sup>(6)</sup>	1500		

1. All voltage values, except the differential voltage are referenced to  $(V_{CC-})$
2. The magnitude of the input and output voltages must never exceed the supply rail  $\pm 0.3$  V
3. Short circuits can cause excessive heating. These values are typical
4. Human body model: a 100 pF capacitor is charged to the specified voltage, then discharged through a 1.5 kΩ resistor between two pins of the device. This is done for all couples of connected pin combinations while the other pins are floating.
5. Machine model: a 200 pF capacitor is charged to the specified voltage, then discharged directly between two pins of the device with no external series resistor (internal resistor < 5 Ω). This is done for all couples of connected pin combinations while the other pins are floating.
6. Charged device model: all pins and the package are charged together to the specified voltage and then discharged directly to the ground through only one pin. This is done for all pins.

**Table 2. Operating conditions**

Symbol	Parameter	Value	Unit	
$V_{CC}$	Supply voltage	$0\text{ °C} < T_{amb} < 125\text{ °C}$	1.8 to 5	V
		$-40\text{ °C} < T_{amb} < 125\text{ °C}$	2 to 5	
$V_{icm}$	Common mode input voltage range	$-40\text{ °C} < T_{amb} < 85\text{ °C}$	$(V_{CC-}) - 0.2$ to $(V_{CC+}) + 0.2$	
		$85\text{ °C} < T_{amb} < 125\text{ °C}$	$(V_{CC-})$ to $(V_{CC+})$	
$T_{oper}$	Operating temperature range	-40 to 125	°C	

## 2 Electrical characteristics

**Table 3. Electrical characteristics at  $V_{CC} = 2\text{ V}$ ,  $T_{amb} = 25\text{ °C}$ , and full  $V_{icm}$  range (unless otherwise specified)**

Symbol	Parameter	Test conditions <sup>(1)</sup>	Min.	Typ.	Max.	Unit
$V_{IO}$	Input offset voltage	TS3021A		0.5	2	mV
		TS3021		0.5	6	
		$-40\text{ °C} < T_{amb} < 125\text{ °C}$ , TS3021A			4	
		$-40\text{ °C} < T_{amb} < 125\text{ °C}$ , TS3021			7	
$\Delta V_{IO}/\Delta T$	Input offset voltage drift	$-40\text{ °C} < T_{amb} < 125\text{ °C}$		3	20	$\mu\text{V}/\text{°C}$
$I_{IO}$	Input offset current <sup>(2)</sup>	$T_{amb}$		1	20	nA
		$-40\text{ °C} < T_{amb} < 125\text{ °C}$			100	
$I_{IB}$	Input bias current <sup>(2)</sup>	$T_{amb}$		86	160	nA
		$-40\text{ °C} < T_{amb} < 125\text{ °C}$			300	
$I_{CC}$	Supply current	No load, output high, $V_{icm} = 0\text{ V}$		73	90	$\mu\text{A}$
		No load, output high, $V_{icm} = 0\text{ V}$ , $-40\text{ °C} < T_{amb} < 125\text{ °C}$			115	
		No load, output low, $V_{icm} = 0\text{ V}$		84	105	
		No load, output low, $V_{icm} = 0\text{ V}$ , $-40\text{ °C} < T_{amb} < 125\text{ °C}$			125	
$I_{SC}$	Short-circuit current	Source		9		mA
		Sink		10		
$V_{OH}$	Output voltage high	$I_{source} = 1\text{ mA}$	1.88	1.92		V
		$-40\text{ °C} < T_{amb} < 125\text{ °C}$	1.80			
$V_{OL}$	Output voltage low	$I_{sink} = 1\text{ mA}$		60	100	mV
		$-40\text{ °C} < T_{amb} < 125\text{ °C}$			150	
CMRR	Common mode rejection ratio	$0 < V_{icm} < 2\text{ V}$		67		dB
SVR	Supply voltage rejection	$\Delta V_{CC} = 2\text{ to }5\text{ V}$	58	73		
$TP_{LH}$	Propagation delay, low to high output level <sup>(3)</sup>	$V_{icm} = 0\text{ V}$ , $f = 10\text{ kHz}$ , $CL = 50\text{ pF}$ , overdrive = 100 mV		38	60	ns
		$V_{icm} = 0\text{ V}$ , $f = 10\text{ kHz}$ , $CL = 50\text{ pF}$ , overdrive = 20 mV		48	75	
$TP_{HL}$	Propagation delay, high to low output level <sup>(4)</sup>	$V_{icm} = 0\text{ V}$ , $f = 10\text{ kHz}$ , $CL = 50\text{ pF}$ , overdrive = 100 mV		40	60	ns
		$V_{icm} = 0\text{ V}$ , $f = 10\text{ kHz}$ , $CL = 50\text{ pF}$ , overdrive = 20 mV		49	75	
$T_F$	Fall time	$f = 10\text{ kHz}$ , $CL = 50\text{ pF}$ , $RL = 10\text{ k}\Omega$ , overdrive = 100 mV		8		
$T_R$	Rise time	$f = 10\text{ kHz}$ , $CL = 50\text{ pF}$ , $RL = 10\text{ k}\Omega$ , overdrive = 100 mV		9		

1. All values over the temperature range are guaranteed through correlation and simulation. No production test is performed at the temperature range limits
2. Maximum values include unavoidable inaccuracies of the industrial tests
3. Response time is measured 10%/90% of the final output value with the following conditions: inverting input voltage ( $IN^-$ ) =  $V_{icm}$  and non-inverting input voltage ( $IN^+$ ) moving from  $V_{icm} - 100\text{ mV}$  to  $V_{icm} + \text{overdrive}$ .
4. Response time is measured 10%/90% of the final output value with the following conditions: Inverting input voltage ( $IN^-$ ) =  $V_{icm}$  and non-inverting input voltage ( $IN^+$ ) moving from  $V_{icm} + 100\text{ mV}$  to  $V_{icm} - \text{overdrive}$ .

**Table 4. Electrical characteristics at  $V_{CC} = 3.3\text{ V}$ ,  $T_{amb} = 25\text{ °C}$ , and full  $V_{icm}$  range (unless otherwise specified)**

Symbol	Parameter	Test conditions <sup>(1)</sup>	Min.	Typ.	Max.	Unit
$V_{IO}$	Input offset voltage	TS3021A		0.5	2	mV
		TS3021		0.5	6	
		-40 °C < $T_{amb}$ < 125 °C, TS3021A			4	
		-40 °C < $T_{amb}$ < 125 °C, TS3021			7	
$\Delta V_{io}/\Delta T$	Input offset voltage drift	-40 °C < $T_{amb}$ < 125 °C		3	20	$\mu\text{V}/\text{°C}$
$I_{IO}$	Input offset current <sup>(2)</sup>	$T_{amb}$		1	20	nA
		-40 °C < $T_{amb}$ < 125 °C			100	
$I_{IB}$	Input bias current <sup>(2)</sup>	$T_{amb}$		86	160	nA
		-40 °C < $T_{amb}$ < 125 °C			300	
$I_{CC}$	Supply current	No load, output high, $V_{icm} = 0\text{ V}$		75	90	$\mu\text{A}$
		No load, output high, $V_{icm} = 0\text{ V}$ , -40 °C < $T_{amb}$ < 125 °C			120	
		No load, output low, $V_{icm} = 0\text{ V}$		86	110	
		No load, output low, $V_{icm} = 0\text{ V}$ , -40 °C < $T_{amb}$ < 125 °C			125	
$I_{SC}$	Short-circuit current	Source		26		mA
		Sink		24		
$V_{OH}$	Output voltage high	$I_{source} = 1\text{ mA}$	3.20	3.25		V
		-40 °C < $T_{amb}$ < 125 °C	3.10			
$V_{OL}$	Output voltage low	$I_{sink} = 1\text{ mA}$		40	80	mV
		-40 °C < $T_{amb}$ < 125 °C			150	
CMRR	Common mode rejection ratio	$0 < V_{icm} < 3.3\text{ V}$		75		dB
SVR	Supply voltage rejection	$\Delta V_{cc} = 2\text{ to }5\text{ V}$	58	73		
$TP_{LH}$	Propagation delay, low to high output level <sup>(3)</sup>	$V_{icm} = 0\text{ V}$ , $f = 10\text{ kHz}$ , $CL = 50\text{ pF}$ , overdrive = 100 mV		39	65	ns
		$V_{icm} = 0\text{ V}$ , $f = 10\text{ kHz}$ , $CL = 50\text{ pF}$ , overdrive = 20 mV		50	85	
$TP_{HL}$	Propagation delay, high to low output level <sup>(4)</sup>	$V_{icm} = 0\text{ V}$ , $f = 10\text{ kHz}$ , $CL = 50\text{ pF}$ , overdrive = 100 mV		41	65	ns
		$V_{icm} = 0\text{ V}$ , $f = 10\text{ kHz}$ , $CL = 50\text{ pF}$ , overdrive = 20 mV		51	80	
$T_F$	Fall time	$f = 10\text{ kHz}$ , $CL = 50\text{ pF}$ , $RL = 10\text{ k}\Omega$ , overdrive = 100 mV		5		ns
$T_R$	Rise time	$f = 10\text{ kHz}$ , $CL = 50\text{ pF}$ , $RL = 10\text{ k}\Omega$ , overdrive = 100 mV		7		

1. All values over the temperature range are guaranteed through correlation and simulation. No production test is performed at the temperature range limits
2. Maximum values include unavoidable inaccuracies of the industrial tests
3. Response time is measured 10%/90% of the final output value with the following conditions: inverting input voltage ( $IN^-$ ) =  $V_{icm}$  and non-inverting input voltage ( $IN^+$ ) moving from  $V_{icm} - 100\text{ mV}$  to  $V_{icm} + \text{overdrive}$ .
4. Response time is measured 10%/90% of the final output value with the following conditions: Inverting input voltage ( $IN^-$ ) =  $V_{icm}$  and non-inverting input voltage ( $IN^+$ ) moving from  $V_{icm} + 100\text{ mV}$  to  $V_{icm} - \text{overdrive}$ .

**Table 5. Electrical characteristics at  $V_{CC} = 5\text{ V}$ ,  $T_{amb} = 25\text{ °C}$ , and full  $V_{icm}$  range (unless otherwise specified)**

Symbol	Parameter	Test conditions <sup>(1)</sup>	Min.	Typ.	Max.	Unit
$V_{IO}$	Input offset voltage	TS3021A		0.5	2	mV
		TS3021		0.5	6	
		$-40\text{ °C} < T_{amb} < 125\text{ °C}$ , TS3021A			4	
		$-40\text{ °C} < T_{amb} < 125\text{ °C}$ , TS3021			7	
$\Delta V_{io}/\Delta T$	Input offset voltage drift	$-40\text{ °C} < T_{amb} < 125\text{ °C}$		3	20	$\mu\text{V}/\text{°C}$
$I_{IO}$	Input offset current <sup>(2)</sup>	$T_{amb}$		1	20	nA
		$-40\text{ °C} < T_{amb} < 125\text{ °C}$			100	
$I_{IB}$	Input bias current <sup>(2)</sup>	$T_{amb}$		86	160	nA
		$-40\text{ °C} < T_{amb} < 125\text{ °C}$			300	
$I_{CC}$	Supply current	No load, output high, $V_{icm} = 0\text{ V}$		77	95	$\mu\text{A}$
		No load, output high, $V_{icm} = 0\text{ V}$ , $-40\text{ °C} < T_{amb} < 125\text{ °C}$			125	
		No load, output low, $V_{icm} = 0\text{ V}$		89	115	
		No load, output low, $V_{icm} = 0\text{ V}$ , $-40\text{ °C} < T_{amb} < 125\text{ °C}$			135	
$I_{SC}$	Short-circuit current	Source		51		mA
		Sink		40		
$V_{OH}$	Output voltage high	$I_{source} = 4\text{ mA}$	4.80	4.84		V
		$-40\text{ °C} < T_{amb} < 125\text{ °C}$	4.70			
$V_{OL}$	Output voltage low	$I_{sink} = 4\text{ mA}$		130	180	mV
		$-40\text{ °C} < T_{amb} < 125\text{ °C}$			250	
CMRR	Common mode rejection ratio	$0 < V_{icm} < 5\text{ V}$		79		dB
SVR	Supply voltage rejection	$\Delta V_{CC} = 2\text{ to }5\text{ V}$	58	73		
$TP_{LH}$	Propagation delay, low to high output level <sup>(3)</sup>	$V_{icm} = 0\text{ V}$ , $f = 10\text{ kHz}$ , $CL = 50\text{ pF}$ , overdrive = 100 mV		42	75	ns
		$V_{icm} = 0\text{ V}$ , $f = 10\text{ kHz}$ , $CL = 50\text{ pF}$ , overdrive = 20 mV		54	105	
$TP_{HL}$	Propagation delay, high to low output level <sup>(4)</sup>	$V_{icm} = 0\text{ V}$ , $f = 10\text{ kHz}$ , $CL = 50\text{ pF}$ , overdrive = 100 mV		45	75	ns
		$V_{icm} = 0\text{ V}$ , $f = 10\text{ kHz}$ , $CL = 50\text{ pF}$ , overdrive = 20 mV		55	95	
$T_F$	Fall time	$f = 10\text{ kHz}$ , $CL = 50\text{ pF}$ , $RL = 10\text{ k}\Omega$ , overdrive = 100 mV		4		ns
$T_R$	Rise time	$f = 10\text{ kHz}$ , $CL = 50\text{ pF}$ , $RL = 10\text{ k}\Omega$ , overdrive = 100 mV		4		

1. All values over the temperature range are guaranteed through correlation and simulation. No production test is performed at the temperature range limits
2. Maximum values include unavoidable inaccuracies of the industrial tests
3. Response time is measured 10%/90% of the final output value with the following conditions: inverting input voltage ( $IN^-$ ) =  $V_{icm}$  and non-inverting input voltage ( $IN^+$ ) moving from  $V_{icm} - 100\text{ mV}$  to  $V_{icm} + \text{overdrive}$ .
4. Response time is measured 10%/90% of the final output value with the following conditions: Inverting input voltage ( $IN^-$ ) =  $V_{icm}$  and non-inverting input voltage ( $IN^+$ ) moving from  $V_{icm} + 100\text{ mV}$  to  $V_{icm} - \text{overdrive}$ .

### 3 Electrical characteristic curves

**Figure 1. Current consumption vs. supply voltage (Vicm = 0 V, output high)**

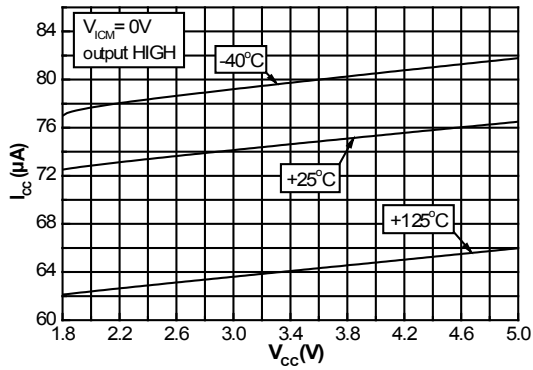

**Figure 2. Current consumption vs. supply voltage (Vicm = Vcc output high)**

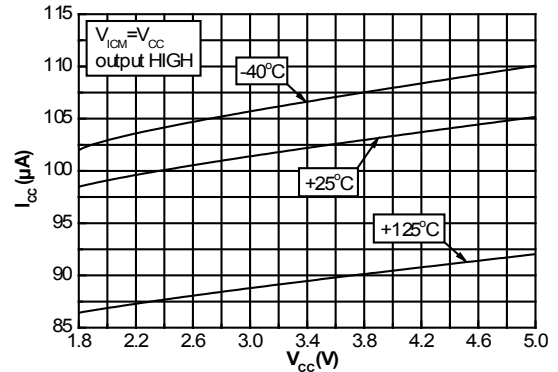

**Figure 3. Current consumption vs. supply voltage (Vicm = 0 V, output low)**

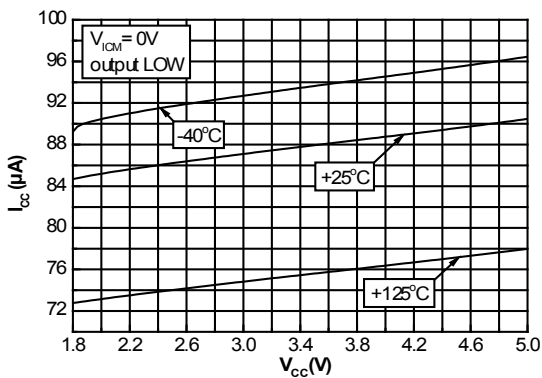

**Figure 4. Current consumption vs. supply voltage (Vicm = Vcc output low)**

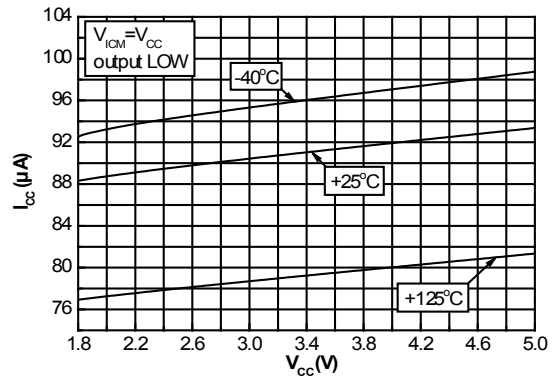

**Figure 5. Output voltage vs. source current, Vcc = 2 V**

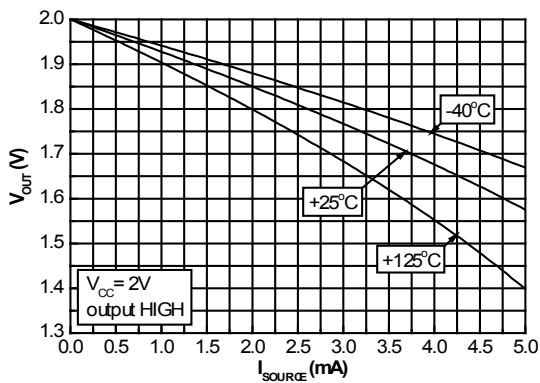

**Figure 6. Output voltage vs. sink current, Vcc = 2 V**

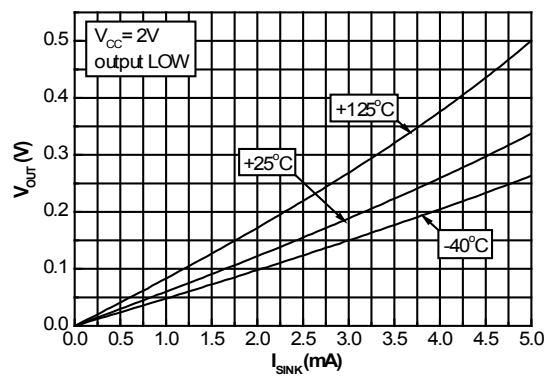

Figure 7. Output voltage vs. source current,  $V_{CC} = 3.3\text{ V}$

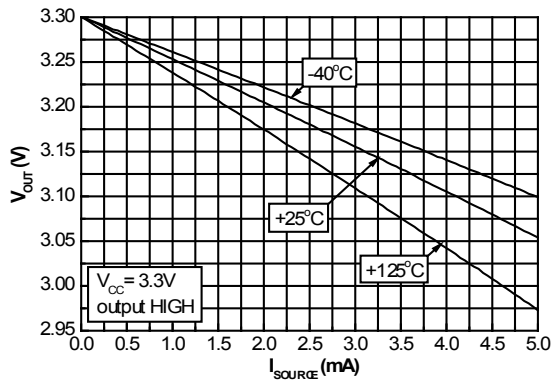

Figure 8. Output voltage vs. sink current,  $V_{CC} = 3.3\text{ V}$

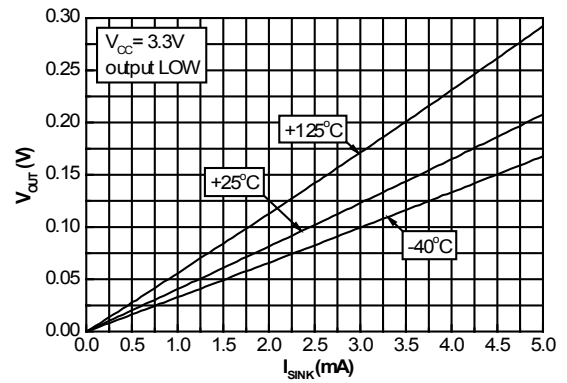

Figure 9. Output voltage vs. source current,  $V_{CC} = 5\text{ V}$

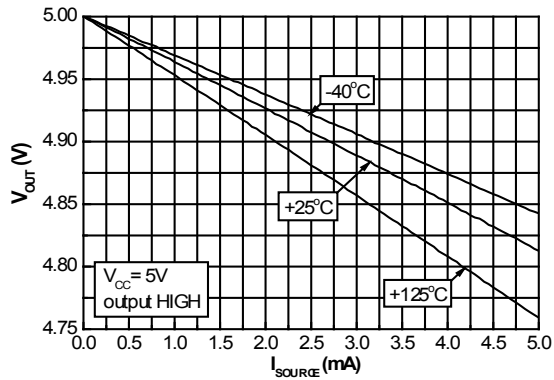

Figure 10. Output voltage vs. sink current,  $V_{CC} = 5\text{ V}$

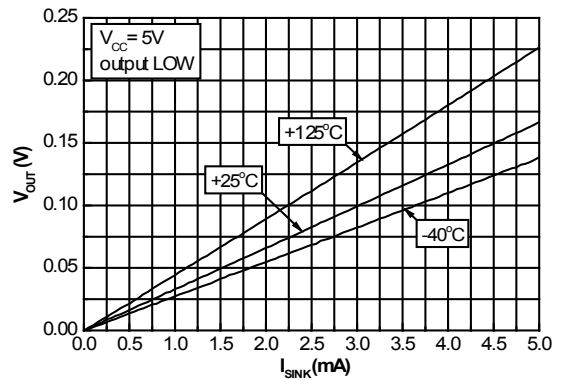

Figure 11. Input offset voltage vs. temperature and common mode voltage

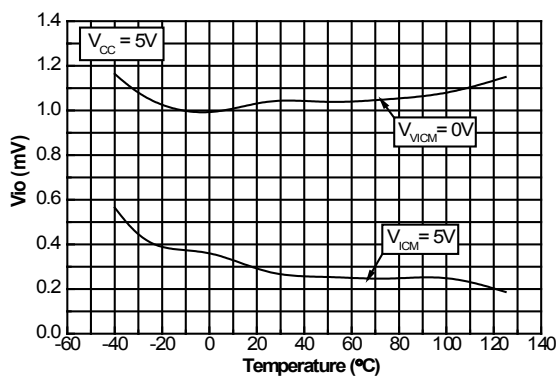

Figure 12. Input bias current vs. temperature and input voltage

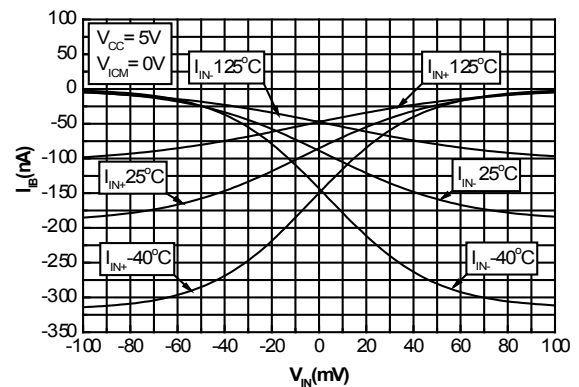

Figure 13. Current consumption vs. commutation frequency

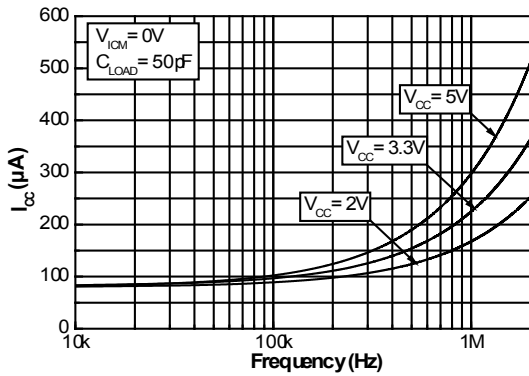

Figure 14. Propagation delay (HL) vs. overdrive at  $V_{CC} = 2V$ ,  $V_{ICM} = 0V$

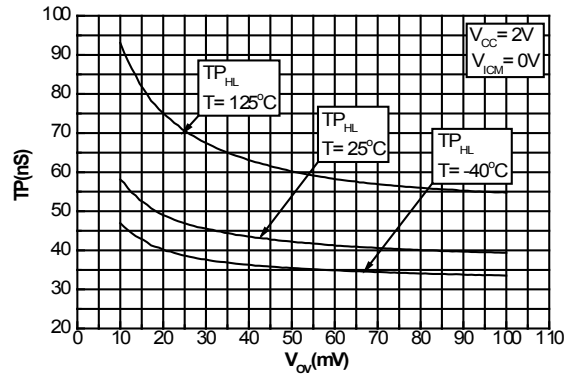

Figure 15. Propagation delay (HL) vs. overdrive at  $V_{CC} = 2V$ ,  $V_{ICM} = V_{CC}$

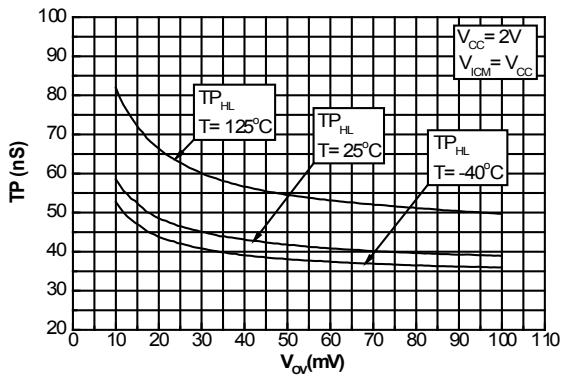

Figure 16. Propagation delay (LH) vs. overdrive at  $V_{CC} = 2V$ ,  $V_{ICM} = 0V$

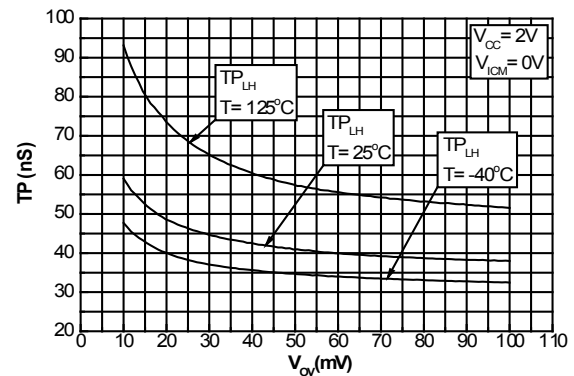

Figure 17. Propagation delay (LH) vs. overdrive at  $V_{CC} = 2V$ ,  $V_{ICM} = V_{CC}$

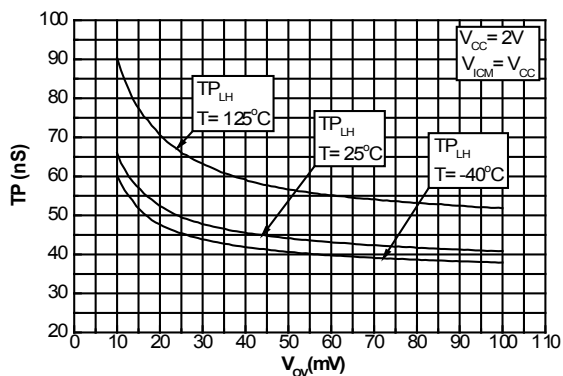

Figure 18. Propagation delay (HL) vs. overdrive at  $V_{CC} = 3.3V$ ,  $V_{ICM} = 0V$

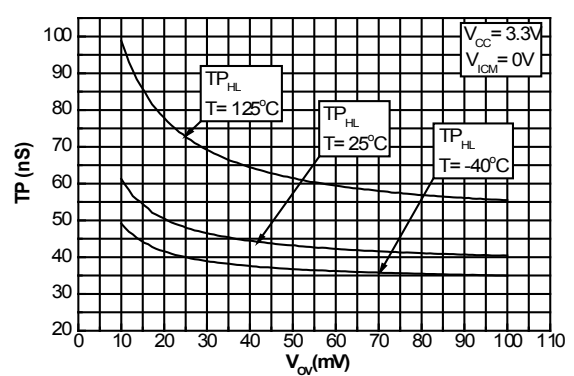



Figure 19. Propagation delay (HL) vs. overdrive at  $V_{CC} = 3.3\text{ V}$ ,  $V_{ICM} = V_{CC}$

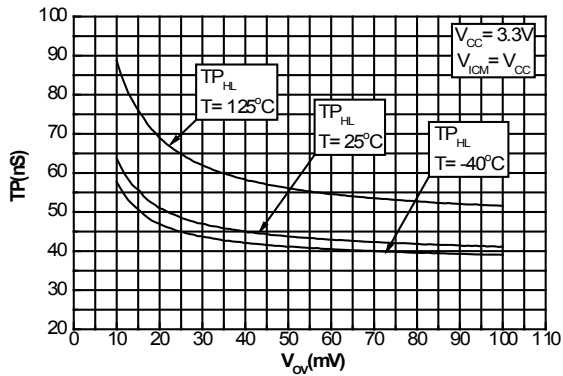

Figure 20. Propagation delay (LH) vs. overdrive at  $V_{CC} = 3.3\text{ V}$ ,  $V_{ICM} = 0\text{ V}$

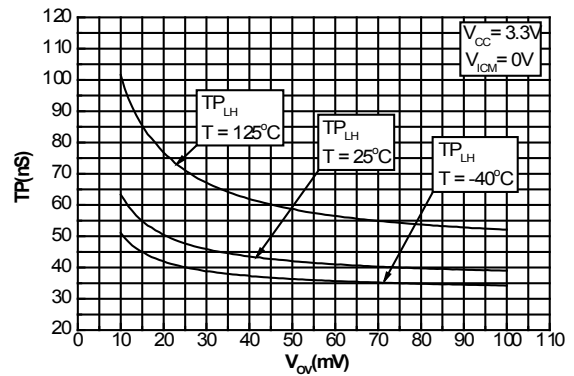

Figure 21. Propagation delay (LH) vs. overdrive at  $V_{CC} = 3.3\text{ V}$ ,  $V_{ICM} = V_{CC}$

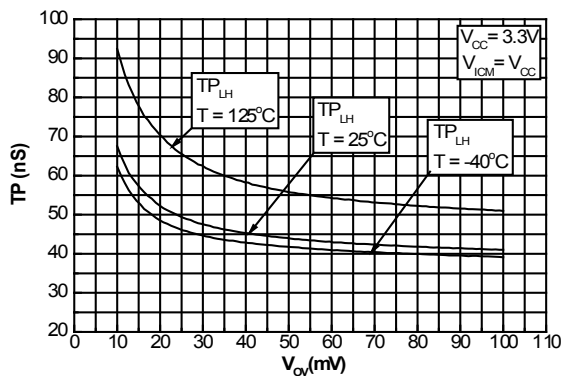

Figure 22. Propagation delay (HL) vs. overdrive at  $V_{CC} = 5\text{ V}$ ,  $V_{ICM} = 0\text{ V}$

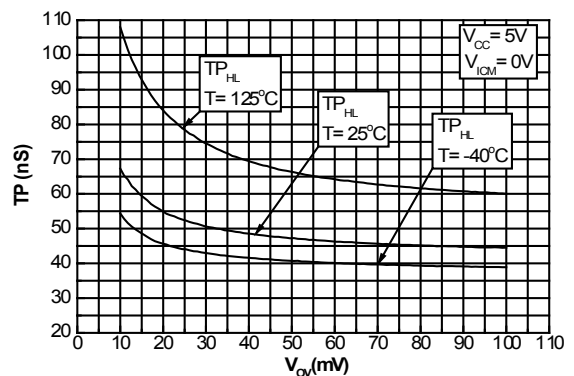

Figure 23. Propagation delay (HL) vs. overdrive at  $V_{CC} = 5\text{ V}$ ,  $V_{ICM} = V_{CC}$

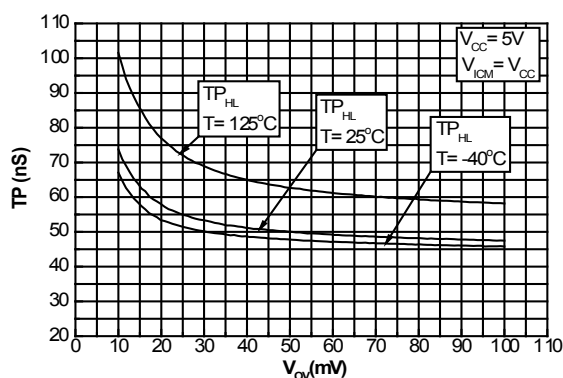

Figure 24. Propagation delay (LH) vs. overdrive at  $V_{CC} = 5\text{ V}$ ,  $V_{ICM} = 0\text{ V}$

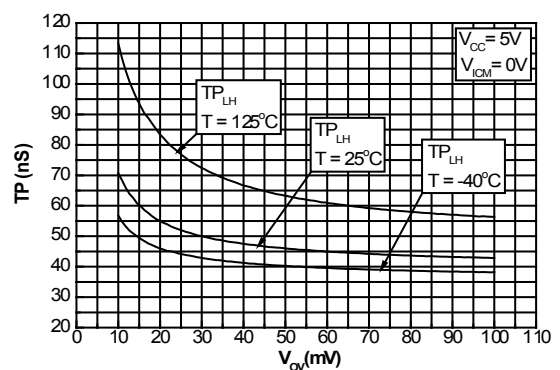

Figure 25. Propagation delay (LH) vs. overdrive at  $V_{CC} = 5\text{ V}$ ,  $V_{ICM} = V_{CC}$

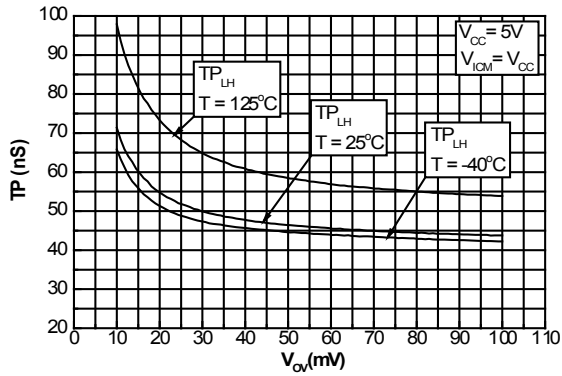

Figure 26. Propagation delay vs. temperature,  $V_{CC} = 5\text{ V}$ , overdrive = 100 mV

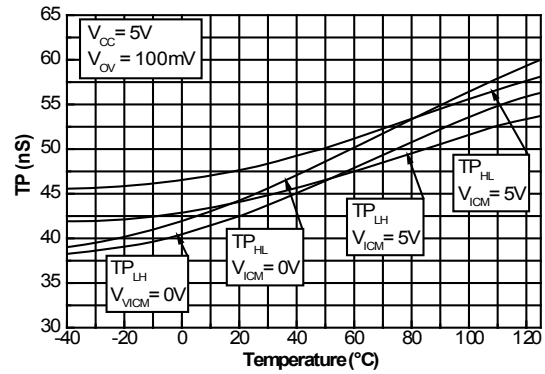
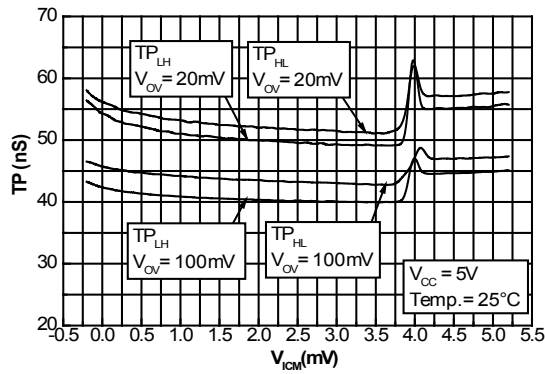

Figure 27. Propagation delay vs. common mode voltage,  $V_{CC} = 5\text{ V}$



## 4 Package information

---

In order to meet environmental requirements, ST offers these devices in different grades of **ECOPACK** packages, depending on their level of environmental compliance. ECOPACK specifications, grade definitions and product status are available at: [www.st.com](http://www.st.com). ECOPACK is an ST trademark.

## 4.1 SOT23-5 package information

Figure 28. SOT23-5 package outline

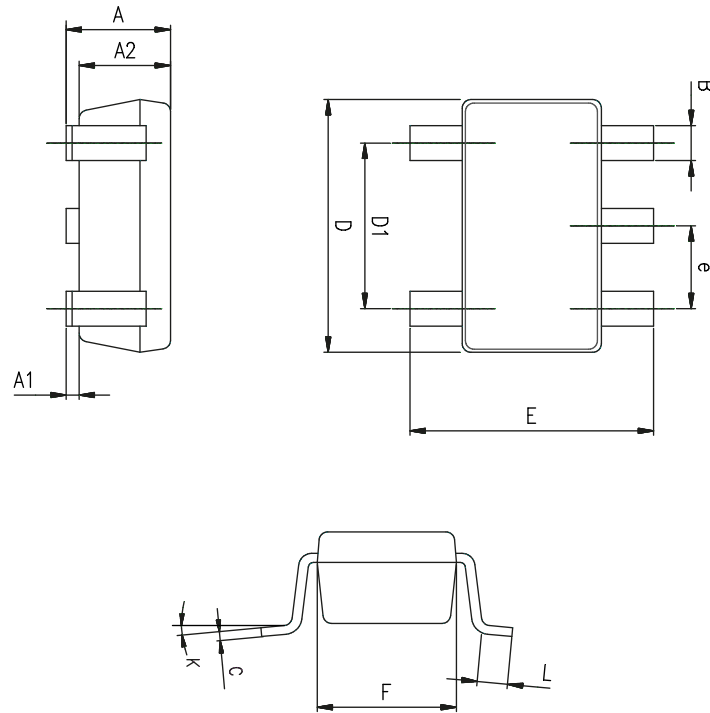

Table 6. SOT23-5 mechanical data

Ref.	Dimensions					
	Millimeters			Inches		
	Min.	Typ.	Max.	Min.	Typ.	Max.
A	0.90	1.20	1.45	0.035	0.047	0.057
A1			0.15			0.006
A2	0.90	1.05	1.30	0.035	0.041	0.051
B	0.35	0.40	0.50	0.014	0.016	0.020
C	0.09	0.15	0.20	0.004	0.006	0.008
D	2.80	2.90	3.00	0.110	0.114	0.118
D1		1.90			0.075	
e		0.95			0.037	
E	2.60	2.80	3.00	0.102	0.110	0.118
F	1.50	1.60	1.75	0.059	0.063	0.069
L	0.10	0.35	0.60	0.004	0.014	0.024
K	0 degrees		10 degrees	0 degrees		10 degrees

## 4.2 SC70-5 (or SOT323-5) package information

Figure 29. SC70-5 (or SOT323-5) package outline

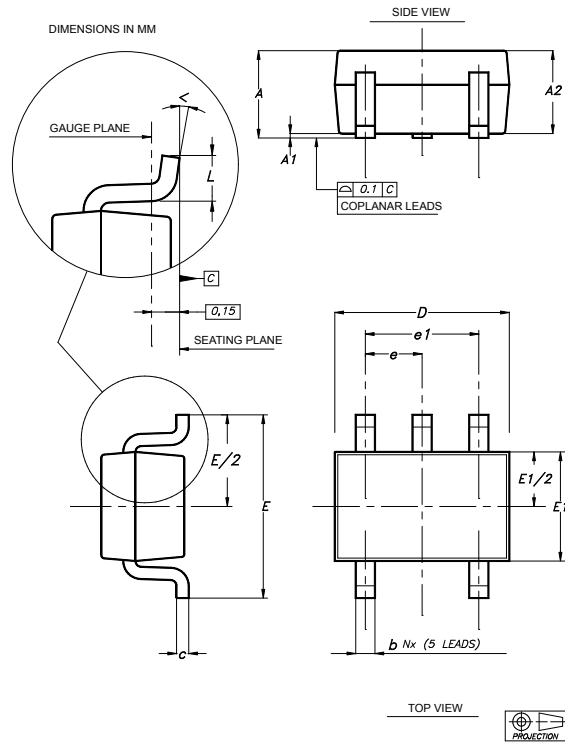

Table 7. SC70-5 (or SOT323-5) mechanical data

Ref.	Dimensions					
	Millimeters			Inches		
	Min.	Typ.	Max.	Min.	Typ.	Max.
A	0.80		1.10	0.032		0.043
A1			0.10			0.004
A2	0.80	0.90	1.00	0.032	0.035	0.039
b	0.15		0.30	0.006		0.012
c	0.10		0.22	0.004		0.009
D	1.80	2.00	2.20	0.071	0.079	0.087
E	1.80	2.10	2.40	0.071	0.083	0.094
E1	1.15	1.25	1.35	0.045	0.049	0.053
e		0.65			0.025	
e1		1.30			0.051	
L	0.26	0.36	0.46	0.010	0.014	0.018
<	0°		8°	0°		8°

## 5 Ordering information

**Table 8. Order codes**

Order code	Temperature range	Package	Packaging	Marking
TS3021ILT	-40 to 125 °C	SOT23-5	Tape and reel	K520
TS3021IYLT <sup>(1)</sup>				K529
TS3021ICT		SC70-5		K52
TS3021IYCT <sup>(1)</sup>				K5S
TS3021AILT				SOT23-5

1. Qualified and characterized according to AEC Q100 and Q003 or equivalent, advanced screening according to AEC Q001 and Q 002 or equivalent

## Revision history

**Table 9. Document revision history**

Date	Revision	Changes
01-Jun-2006	1	Initial release
01-Sep-2006	2	Dual version added Pinout of single TS3021 corrected Modified temperature range for input common mode voltage
22-Feb-2007	3	Addition of MiniSO-8 package for dual version
17-Oct-2007	4	Marking corrected for SO-8 package Thermal resistance values corrected in AMR table Notes on ESD added in AMR table
04-Dec-2008	5	Dual version (TS3022) removed ESD tolerance modified in Table 1: Absolute maximum ratings Made the following changes in Table 3: – modified $V_{io}$ typical value and maximum limits – modified lib typical value – modified $I_{cc}$ typical values and corrected maximum limits – modified $I_{sc}$ typical values – modified $V_{oh}$ and $V_{ol}$ typical values – modified CMRR and SVR typical values – modified TPI and TPIh typical values All curves modified
03-Jan-2013	6	Features: added “automotive qualification”; added Related products. Table 1 and Table 2: $V_{dd}$ and $V_{cc}$ replaced by ( $V_{cc-}$ ) and ( $V_{cc+}$ ) respectively. Table 3, Table 4, and Table 5: replaced $\Delta V_{io}$ symbol with $\Delta V_{io}/\Delta T$ . Table 6 and Table 7: minor update (added angle dimensions to “inches” columns). Table 8: added automotive order code
02-Jun-2015	7	Table 3, Table 4, and Table 5: updated $V_{io}$ parameter Table 6: small “rounding-off modifications to inches parameter Table 8: added order code TS3021AILT
07-Jul-2016	8	Added new part number TS3021A Updated document layout Table 3, Table 4, and Table 5: updated VIO test conditions and values.
17-Oct-2022	9	Added new TS3021IYCT order code in Table 8. Order codes

**IMPORTANT NOTICE – READ CAREFULLY**

STMicroelectronics NV and its subsidiaries (“ST”) reserve the right to make changes, corrections, enhancements, modifications, and improvements to ST products and/or to this document at any time without notice. Purchasers should obtain the latest relevant information on ST products before placing orders. ST products are sold pursuant to ST’s terms and conditions of sale in place at the time of order acknowledgment.

Purchasers are solely responsible for the choice, selection, and use of ST products and ST assumes no liability for application assistance or the design of purchasers’ products.

No license, express or implied, to any intellectual property right is granted by ST herein.

Resale of ST products with provisions different from the information set forth herein shall void any warranty granted by ST for such product.

ST and the ST logo are trademarks of ST. For additional information about ST trademarks, refer to [www.st.com/trademarks](http://www.st.com/trademarks). All other product or service names are the property of their respective owners.

Information in this document supersedes and replaces information previously supplied in any prior versions of this document.

© 2022 STMicroelectronics – All rights reserved