



TRC-120 Series—Fixed Output and Dimmable 120W Switch Mode LED Drivers Constant Current

Electrical Specifications

Input Voltage Range:	100 - 277 Nom. Vac (90 - 305 V Min/Max)
Frequency:	50/60 Hz Nom. (47-63 Hz Min/Max)
Power Factor:	>0.90 @ 75-100% load, 100-277V
Input Current:	1.50 A @ 100 Vac, 0.75 A @ 220Vac
Maximum Power:	120W
THD:	≤ 20% @ 75-100% load, 120-277V
Line Regulation:	± 1%
Load Regulation:	± 3%
Turn-on Time Delay:	120V: 1.2S Typical, 2.0S max 220V: 0.6S Typical, 1.2S max
Output Protection:	Over-Voltage, Over-Current, Over-Temperature, Output Short Circuit Protection

Environmental Specifications

Minimum Starting Temp:	-35°C
Max Case Temperature:	90°C (DT models), 88.2°C (350mA ST), 89.5°C (all others)
Storage Temperature:	-40°C to +85°C
Humidity:	10% to 100%
Cooling:	Convection
Sound Rating:	Class A
MTBF:	250,000 Hours @ 80% load, 110Vac, 25°C ambient conditions per MIL-HDBK-217F
Lifetime:	67,000 Hours @ 220V, 80% load, Tc=60°C



- Total Power: 120 Watts
- Input Voltage: 100-277 Vac Nom.
- UL Dry & Damp Location Rated
- IP67
- High Efficiency
- High Power Factor with Active Correction
- Output and Lightning Protection

Safety Certification	Standard
CUL	UL8750, UL1012, CSA-C22.2 No. 107.1
CE	EN 61347-1, EN61347-2-13
EMC Standard	Notes
EN 55015	Conducted emission
EN 61000-3-2	Harmonic current emissions
EN 61000-3-3	Voltage fluctuations and flicker
EN 61000-4-2	Electrostatic discharge
EN 61000-4-3	RFE Field Susceptibility test
EN 61000-4-4	Electrical Fast Transient
EN 61000-4-5	Surge Immunity Test, AC Power Line: line to line 4 kV; line to earth 6 kV
EN 61000-4-6	Conducted Radio Frequency
EN 61000-4-8	Power Frequency Magnetic Field Test
EN 61000-4-11	Voltage Dips
EN 61547	Electromagnetic Immunity

Constant Current - Product Specifications

Model Number	Output Current (mA ±3%)	Output Voltage Range (Vdc)	Max. Output Power (W)	Typical Efficiency
TRC-120S035ST	350	206-343	120	92%
TRC-120S045ST	450	160-266	120	92%
TRC-120S070ST	700	103-171	120	92%
TRC-120S105ST	1050	68-114	120	91%
TRC-120S140ST	1400	52-86	120	91%
TRC-120S175ST	1750	41-68	120	91%
TRC-120S210ST	2100	34-57	120	91%
TRC-120S245ST	2450	29-49	120	91%
TRC-120S280ST	2800	26-43	120	91%
TRC-120S315ST	3150	23-38	120	90%
TRC-120S350ST	3500	20-34	120	90%
TRC-120S420ST	4200	17-28	120	90%
TRC-120S490ST	4900	14-24	120	89%

Output current is adjustable at the factory from 50-100%

Dimming - Product Specifications

Model Number	Output Current (mA)	Output Voltage Range (Vdc)	Max. Output Power (W)	Typical Efficiency
TRC-120S035DT	350	206-343	120	92%
TRC-120S045DT	450	160-266	120	92%
TRC-120S070DT	700	103-171	120	92%
TRC-120S105DT	1050	68-114	120	91%
TRC-120S140DT	1400	52-86	120	91%
TRC-120S175DT	1750	41-68	120	91%
TRC-120S210DT	2100	34-57	120	91%
TRC-120S245DT	2450	29-49	120	91%
TRC-120S280DT	2800	26-43	120	91%
TRC-120S315DT	3150	23-38	120	90%
TRC-120S350DT	3500	20-34	120	90%
TRC-120S420DT	4200	17-28	120	90%
TRC-120S490DT	4900	14-24	120	89%

Typical Efficiency Full load @ 220Vac



Note:
LED drivers are designed and intended to operate LED loads only. Non-LED loading may be outside the specified design limits of our LED drivers, and therefore cannot be covered by any warranty. If you desire to use our LED drivers to operate non-LED loads please contact us to discuss compatibility.

Specifications subject to change without notice.

Rev 9-1-15

Dimming:

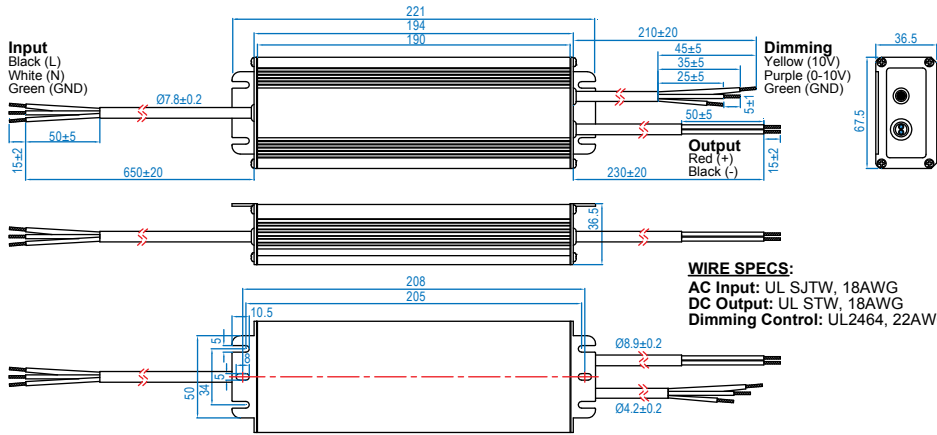

Fixed:

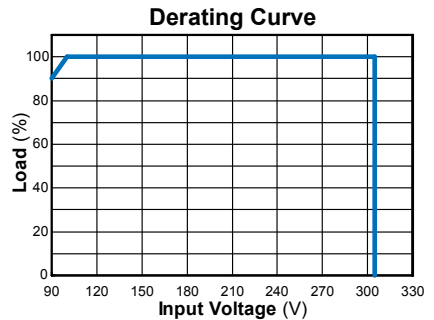
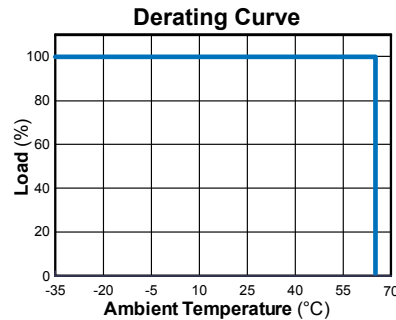
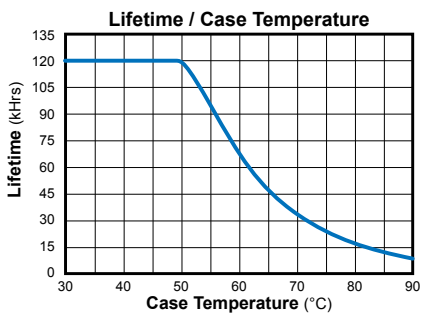
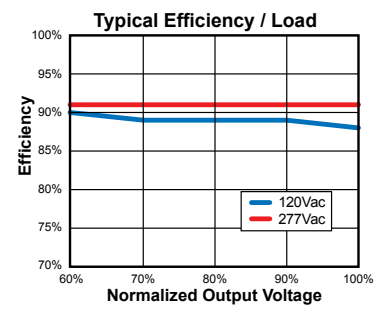
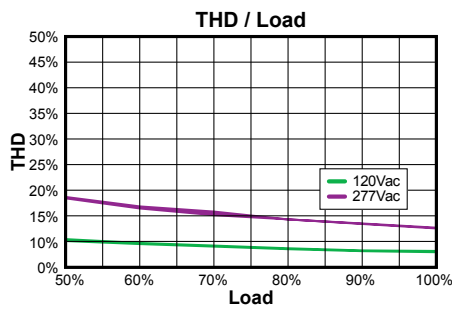
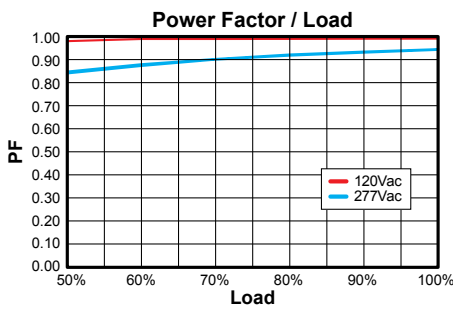
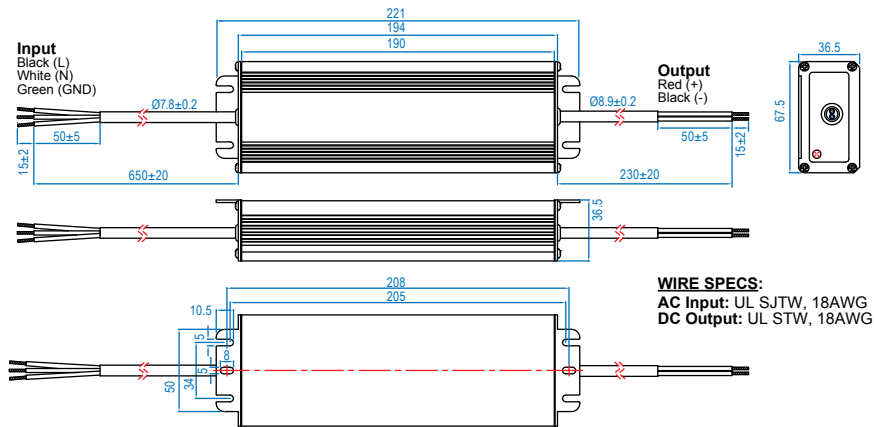

Dimming Control Details

Parameters	Minimum	Typical	Maximum	Notes
Vcc	11.8 V	12 V	12.2 V	For 4900mA
	14.7 V	15 V	15.3 V	For Other models
10V output source current	0 mA	—	10 mA	
Absolute maximum voltage on the 0-10V input pin	-2 V	—	12 V	
Source current on 0-10V input pin	0 mA	—	0.5 mA	
Value of Rin (the resistor inside the LED driver which locate between the 1-10V input and 10V output pin)	19.8 K	20 K	20.2 K	

Option 1 - DC Input

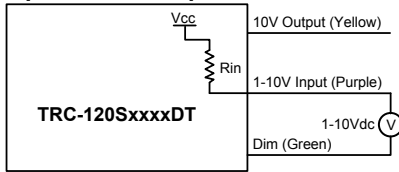

Output Current / Dimming Voltage

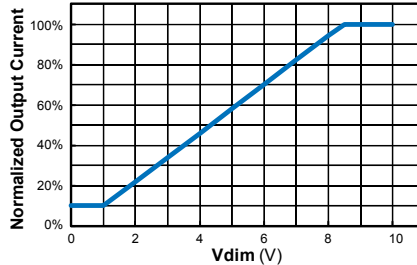

Option 2 - External Resistor (Vcc=12V)

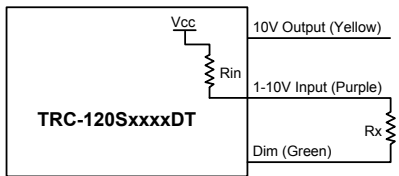

Output Current / Rx

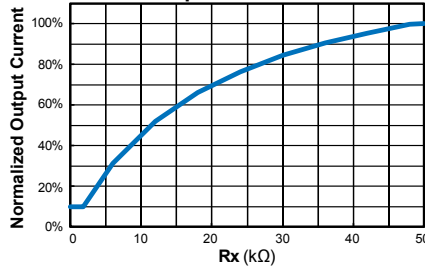

Option 3 - External Resistor (Vcc=15V)

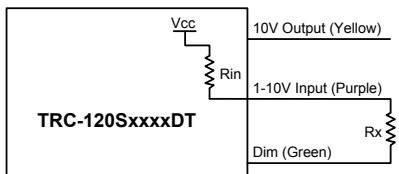

Output Current / Rx

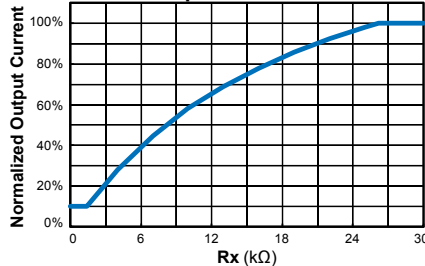

Notes:

1. If the dimming function is not used, the dimming leads should be floated.
2. I_o is actual output current and I_r is rated current without dimming control.
3. For the driver to operate properly, the load voltage must be maintained above the minimum voltage threshold (approx. 50% of the max. output voltage for any given model).
4. If the output voltage is maintained above 50% of the maximum output voltage, the dimming control may be operated over the entire 1-10V range with output current varying from 100% down to practically 10%.
5. The dimming signal is allowed to be less than 1V, however, when it for 0-1V, the output current can maintain about 10% I_r . When it for 8.5-10V, the output current can maintain about 100% I_r .
6. Do not connect the GND of dimming to the output; otherwise, the LED driver cannot work normally.