

Products Catalog

Conductive Polymer Tantalum
Solid Capacitors

POSCAP

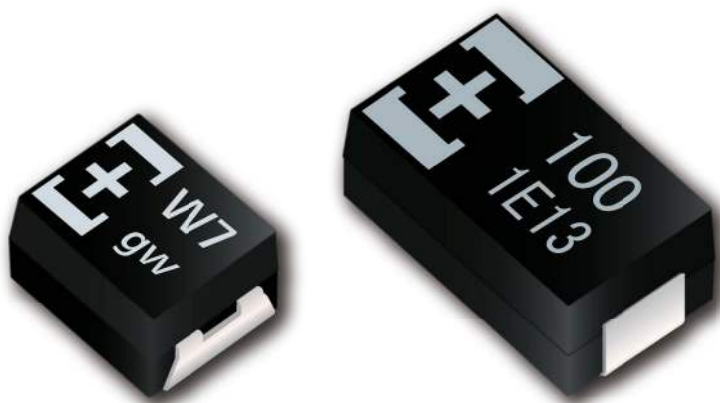

**IN Your
Future**



Conductive Polymer Tantalum Solid Capacitors INDEX

Item		Page
<u>Guidelines and precautions</u>		1
Selection guide	<u>Line up</u>	4
	<u>Diagram</u>	6
	<u>Voltage-Capacitance table</u>	7
	<u>Explanation of part numbers</u>	11
	<u>Mounting specifications</u>	12
	<u>Packing specifications</u>	13
Series	<u>TLE series</u> : 125 °C 2000 h	14
	<u>TPG series</u> : Small size, Low profile	15
	<u>TPS series</u> : 105 °C 2000 h	16
	<u>TPSF series</u> : Super low ESR・Super low ESL	17
	<u>TPE (B size) series</u> : Small size	18
	<u>TPE (D size) series</u> : Low profile	20
	<u>TPF series</u> : Super low ESR	22
	<u>TQS series</u> : High voltage	24
	<u>TQC (B size) series</u> : High voltage	25
	<u>TQC (D size) series</u> : High voltage	27
	<u>TA series</u> : Guaranteed at 85 °C 85 %RH	29
	<u>TV series</u> : Guaranteed at 85 °C 85 %RH	31
	<u>TH series</u> : 125 °C 1000 h	32
	<u>TPB series</u> : Standard	34
	<u>TC series</u> : 125 °C 1000 h	36
	<u>TDC series</u> : 125 °C 1000 h	38
<u>TPC series</u> : Low profile	39	
<u>Catalog Deletion Models</u>		41
<u>EOL Models</u>		42

TPE/TPF/TPC/TQC series some part numbers : Not recommended for new design

TH, TPG series : Not recommended for new design

Safety and Legal Matters to Be Observed

Product specifications and applications

- Please be advised that this product and product specifications are subject to change without notice for improvement purposes. Therefore, please request and confirm the latest delivery specifications that explain the specifications in detail before the final design, or purchase or use of the product, regardless of the application. In addition, do not use this product in any way that deviates from the contents of the company's delivery specifications.
- Unless otherwise specified in this catalog or the delivery specifications, this product is intended for use in general electronic equipment (AV products, home appliances, commercial equipment, office equipment, information and communication equipment, etc.).
When this product is used for the following special cases, please separately discuss the delivery specifications suited to each application with the company. These include applications requiring special quality and reliability, wherein their failures or malfunctions may directly threaten human life or cause harm to the human body (e.g.: space/aircraft equipment, transportation/traffic equipment, combustion equipment, medical equipment, disaster prevention/crime prevention equipment, safety equipment, etc.).

Safety design and product evaluation

- Please ensure safety through protection circuits, redundant circuits, etc., in the customer's system design so that a defect in our company's product will not endanger human life or cause other serious damage.
- This catalog shows the quality and performance of individual parts. The durability of parts varies depending on the usage environment and conditions. Therefore, please ensure to evaluate and confirm the state of each part after it has been mounted in your product in the actual operating environment before use.
If you have any doubts about the safety of this product, then please notify us immediately, and be sure to conduct a technical review including the above protection circuits and redundant circuits at your company.

Laws / Regulations / Intellectual property

- The transportation of dangerous goods as designated by UN numbers, UN classifications, etc., does not apply to this product. In addition, when exporting products, product specifications, and technical information described in this catalog, please comply with the laws and regulations of the countries to which the products are exported, especially those concerning security export control.
- Each model of this product complies with the RoHS Directive (Restriction of the use of hazardous substances in electrical and electronic equipment) (2011/65/EU and (EU) 2015/863). The date of compliance with the RoHS Directive and REACH Regulation varies depending on the product model.
Further, if you are using product models in stock and are not sure whether or not they comply with the RoHS Directive or REACH Regulation, please contact us by selecting "Sales Inquiry" from the inquiry form.
- During the manufacturing process of this product and any of its components and materials to be used, Panasonic does not intentionally use ozone-depleting substances stipulated in the Montreal Protocol and specific bromine-based flame retardants such as PBBs (Poly-Brominated Biphenyls) / PBDEs (Poly-Brominated Diphenyl Ethers). In addition, the materials used in this product are all listed as existing chemical substances based on the Act on the Regulation of Manufacture and Evaluation of Chemical Substances.
- With regard to the disposal of this product, please confirm the disposal method in each country and region where it is incorporated into your company's product and used.
- The technical information contained in this catalog is intended to show only typical operation and application circuit examples of this product. This catalog does not guarantee that such information does not infringe upon the intellectual property rights of Panasonic or any third party, nor imply that the license of such rights has been granted.

Panasonic Industry will assume no liability whatsoever if the use of our company's products deviates from the contents of this catalog or does not comply with the precautions. Please be advised of these restrictions.

Matters to Be Observed When Using This Product (Conductive Polymer Tantalum Solid Capacitors / POSCAP)

Use environments and cleaning conditions

- This product (capacitor) is intended for standard general-purpose use in electronic equipment, and is not designed for use in the specific environments described below. Using the product in such specific environments or service conditions, therefore, may affect the performance of the product.

Please check with us about the performance and reliability of the product first before using the product.

- (1) Used in liquid, such as water, oil, chemicals, and organic solvents.
 - (2) Used in a place exposed to direct sunlight, an outdoor place with no shielding, or a dusty place.
 - (3) Used in a wet place (dew concentration on a resistor, water leakage, etc.), a place exposed to sea breeze, or a place filled with a corrosive gas, such as Cl₂, H₂S, NH₃, SO₂, or NO_x.
 - (4) Used in an environment where static electricity and electromagnetic waves are strong.
 - (5) The product is located close to a heating component or a flammable material, such as a vinyl cable, is placed near the product.
 - (6) The product is used sealed with a resin, etc.
 - (7) Solder flux of the soldered product is cleansed with a solvent, water, and a water-soluble cleaner.
(Be careful with water soluble solder flux.)
 - (8) Used in an environment where an acidic or alkali atmosphere is present.
 - (9) Used in an environment where excessive vibration or impact is applied to the product.
 - (10) Used under a low atmospheric pressure condition or depressurized condition.
- When the capacitor is used in a circuit where an impact voltage is applied or a high voltage is applied in a short period (transient phenomenon) or a high pulse voltage is applied, make sure to use the capacitor at a voltage equal to or lower than its rated voltage.

Response to anomalies and handling conditions

- A short mode is a major failure mode in a capacitor. A short mode is caused by thermal stress created by soldering or a high service temperature, electric stress, mechanical stress, etc. When the capacitor has shorted, take the following steps to ensure your safety.
 - (1) When you see smoke coming out of the shorted product, turn off the main power supply to stop using the capacitor.
Do not place your face or hand near to the smoldering capacitor.
 - (2) The time a shorted capacitor takes to generate smoke ranges from a few seconds to a few minutes, depending on service conditions. If you incorporate a protective circuit, design the circuit to activate in the time preceding the smoke generation.
 - (3) In case smoke gets into your eyes or comes into your mouth, wash the eyes with water or rinse out the mouth immediately.
 - (4) When a current value after the short of the product is extremely large, the shorted capacitor may spark out, which, in the worst scenario, may result in ignition. Ensure the safety of the circuit by, for example, giving it a redundant circuit structure or providing it with a protective circuit.

Reliability and product life

The failure rate of the capacitor is specified based on 0.5%*/1000 h (reliability level 60%), a failure rate conforming to JIS C 5003 (failure rate level). This indicates that the possibility of occurrence of a failure is by no means zero. One of the failure modes is a wear out failure. This happens when the period of guaranteeing the durability and high-temperature/high-humidity resistance of the capacitor is over, changes in the electrical characteristics of the capacitor (product) get larger and its electrolyte gradually deteriorates into an insulating material to create an open mode. Another failure mode is a random failure in which a short mode results mainly because of thermal, electrical, or mechanical stress, etc.

* The failure rate of a small POSCAP of a B2 size or smaller is 1.0%.

Circuit design and circuit board design

- Do not use this capacitor in a high-impedance voltage holding circuit, a coupling circuit, a time constant circuit, or a circuit widely affected by leak current.
- The capacitor is incorporated and used in a circuit where the capacitor operates within a rating range specified in the specifications. Set a service temperature within a specified category temperature range. Do not let a current larger than the allowable ripple current flow in the circuit. Reduce a ripple current to the extent at which the surface temperature of the capacitor's top does not exceed the rated temperature.
(For information about TQC series, please contact us separately.)
- Electrical characteristics values listed in a characteristics table, such as a capacitance and an ESR, are values specified at shipment of the capacitor. These values may change when departing from the specified values in the table under certain electrical or mechanical performance condition. Be careful in choosing a capacitor with the intended electrical characteristics in your design work. Besides, temperature/frequency fluctuations can cause the capacitor's electrical characteristics to change. Confirm such changes in the electrical characteristics and then proceed with your circuit design.
- A leak current may increase even when soldering conditions are within a specified range. The leak current may increase also in a high-temperature non-load test or humidity-resistance non-load test, in which no voltage is applied, a temperature cycle test, etc. In such cases, applying a voltage at a temperature equal to or lower than the highest service temperature of the capacitor reduces the leak current gradually.
- A flow of excessively large rush current created by rapid charge/discharge may result in short circuit or an increase in leak current. When a rush current value exceeds 20 A*, apply a protective circuit to the product.
Note that at leak current measurement, a protective resistance of about 1 kΩ is put in the circuit before the capacitance is charged or discharges.

Mounting and storage conditions

- Set soldering conditions within a specified range. Stricter soldering conditions outside the specified range will cause the deterioration of the electrical characteristics and service life characteristics.
- The capacitor must be kept in storage in an environment that avoids dropping soldering performance or caused trouble with soldering because of moisture absorption by an exterior resin. Store the capacitor, which is put together with a reel in an airtight moisture-proof bag, in a place where a normal temperature and humidity (15 °C to 35 °C and 45%RH to 75%RH) are maintained and direct sunlight is blocked. The storage period is 18 months or less after shipment from the factory.
- Unseal the bag to take out the capacitor right before mounting it on a circuit. Once you take out the capacitor, make sure to use it up. Storage periods for capacitors taken out of bags are as follows.
* These products do not conform to the entire requirements defined in JEDEC J-STD-020 and J-STD-033.

(1) Level 2a	: four weeks at a temperature and a humidity equal to or lower than 30 °C and 60 %RH
(2) Level 3	: 168 hours at a temperature and a humidity equal to or lower than 30 °C and 60 %RH
(3) Level 5	: 48 hours at a temperature and a humidity equal to or lower than 30 °C and 60 %RH

Reference information

Intellectual property

Panasonic Group provides customers with safe products and services. We are also making great efforts to protect our intellectual property rights for Panasonic Group products. Typical patents related to this product are as follows.

[U.S. patent]

USP Nos. 6508800, 6891717, 7158368, 7326260, 8081421, 8149569, 8456804, and 8559167

Line up

Series	Features	Small size/Low profile	Large capacitance	Low ESR	High reliability	High voltage	Guaranteed at 125°C	Category temp. range (°C)	Rated voltage (V)	ESR (mΩ)	Capacitance (μF)	Size code	Size (mm)		
													L	W	H
TLE	Guaranteed at 125 °C 2000 h						●	-55 to 125	2.5 to 6.3	12 to 35	100 to 330	B2	3.5	2.8	1.9
NRFND TPG	Small size Low profile Large capacitance	●	●					-55 to 105	10 to 12.5	35 to 70	33 to 47	B1G	3.5	2.8	1.1
TPS	Small size/Low profile Large capacitance Face down terminal	●	●					-55 to 105	2.5 to 6.3	30 to 35	150 to 330	B1S	3.5	2.8	1.1
TPSF	Low ESR/Small size Large capacitance Face down terminal	●	●	●				-55 to 105	2.0 to 2.5	6 to 9	270	B2S	3.5	2.8	1.9
TPE	Low ESR							-55 to 105	2.0 to 10	9 to 70	47 to 470	B2	3.5	2.8	1.9
								-55 to 105	6.3	35	470	D15E	7.3	4.3	1.4
								-55 to 105	2.5 to 10	7 to 45	68 to 470	D2E	7.3	4.3	1.8
								-55 to 105	2.5 to 10	9 to 40	150 to 680	D3L	7.3	4.3	2.8
								-55 to 105	2.5 to 10	10 to 40	330 to 1500	D4	7.3	4.3	3.8
TPF	Low ESR Large capacitance							-55 to 105	2.0	6	220 to 330	D2E	7.3	4.3	1.8
								-55 to 105	2.5 to 10	5 to 25	150 to 680	D3L	7.3	4.3	2.8
								-55 to 105	2.5 to 6.3	5 to 35	470 to 1000	D4	7.3	4.3	3.8
TQS	High voltage	●					●	-55 to 105	35	100	47	D15S	7.3	4.3	1.4
TQC	High voltage							-55 to 105	16 to 35	90 to 400	3.9 to 47	B2	3.5	2.8	1.9
								-55 to 105	16	40	33	D12	7.3	4.3	1.15
								-55 to 105	16 to 25	55 to 70	22 to 47	D15	7.3	4.3	1.4
								-55 to 105	16 to 35	40 to 150	10 to 150	D2	7.3	4.3	1.9
								-55 to 105	16 to 25	50 to 70	68 to 220	D3L	7.3	4.3	2.8
TA	High reliability							-55 to 105	4.0 to 10	70	47 to 100	B2	3.5	2.8	1.9
								-55 to 105	2.5 to 10	9 to 25	68 to 470	D2E	7.3	4.3	1.8
								-55 to 105	2.5 to 10	15 to 25	150 to 680	D3L	7.3	4.3	2.8
TV	High reliability Guaranteed at 125 °C							-55 to 125	6.3 to 10	25	68 to 150	D2E	7.3	4.3	1.8
								-55 to 125	10	25	150	D3L	7.3	4.3	2.8

TPE/TPF/TPC/TQC series some part numbers : Not recommended for new design

NRFND Not recommended for new design

Line up

Series	Features	Small size/Low profile	Large capacitance	Low ESR	High reliability	High voltage	Guaranteed at 125°C	Category temp. range (°C)	Rated voltage (V)	ESR (mΩ)	Capacitance (μF)	Size code	Size (mm)		
													L	W	H
TPB	Standard							-55 to 105	4.0 to 10	70	33 to 68	B2	3.5	2.8	1.9
								-55 to 105	4.0 to 10	40 to 55	150 to 330	D3L	7.3	4.3	2.8
								-55 to 105	6.3 to 10	35 to 40	220 to 470	D4	7.3	4.3	3.8
NRFND TH	Guaranteed at 125 °C						●	-55 to 125	2.5 to 6.3	15 to 25	150 to 330	D2E	7.3	4.3	1.8
								-55 to 125	2.5 to 10	40 to 45	68 to 220	D2	7.3	4.3	1.9
								-55 to 125	4.0 to 6.3	40	220 to 330	D3L	7.3	4.3	2.8
								-55 to 125	6.3 to 10	35 to 40	220 to 470	D4	7.3	4.3	3.8
TC	Guaranteed at 125 °C						●	-55 to 125	2.5	9	330	B2	3.5	2.8	1.9
								-55 to 125	4.0 to 6.3	15 to 25	100 to 330	D2E	7.3	4.3	1.8
								-55 to 125	2.5 to 10	5 to 25	150 to 680	D3L	7.3	4.3	2.8
								-55 to 125	2.5 to 10	5 to 25	330 to 1000	D4	7.3	4.3	3.8
TDC	High voltage Guaranteed at 125 °C						● ●	-55 to 125	16 to 25	90 to 100	15 to 33	B2	3.5	2.8	1.9
								-55 to 125	16	50	100	D2	7.3	4.3	1.9
								-55 to 125	16 to 25	50 to 70	68 to 150	D3L	7.3	4.3	2.8
TPC	Low profile	●						-55 to 105	6.3 to 12.5	55 to 80	10 to 47	B1	3.5	2.8	1.1
								-55 to 105	6.3 to 10	40 to 100	68 to 330	D2	7.3	4.3	1.9

TPE/TPF/TPC/TQC series some part numbers : Not recommended for new design

NRFND Not recommended for new design

Diagram

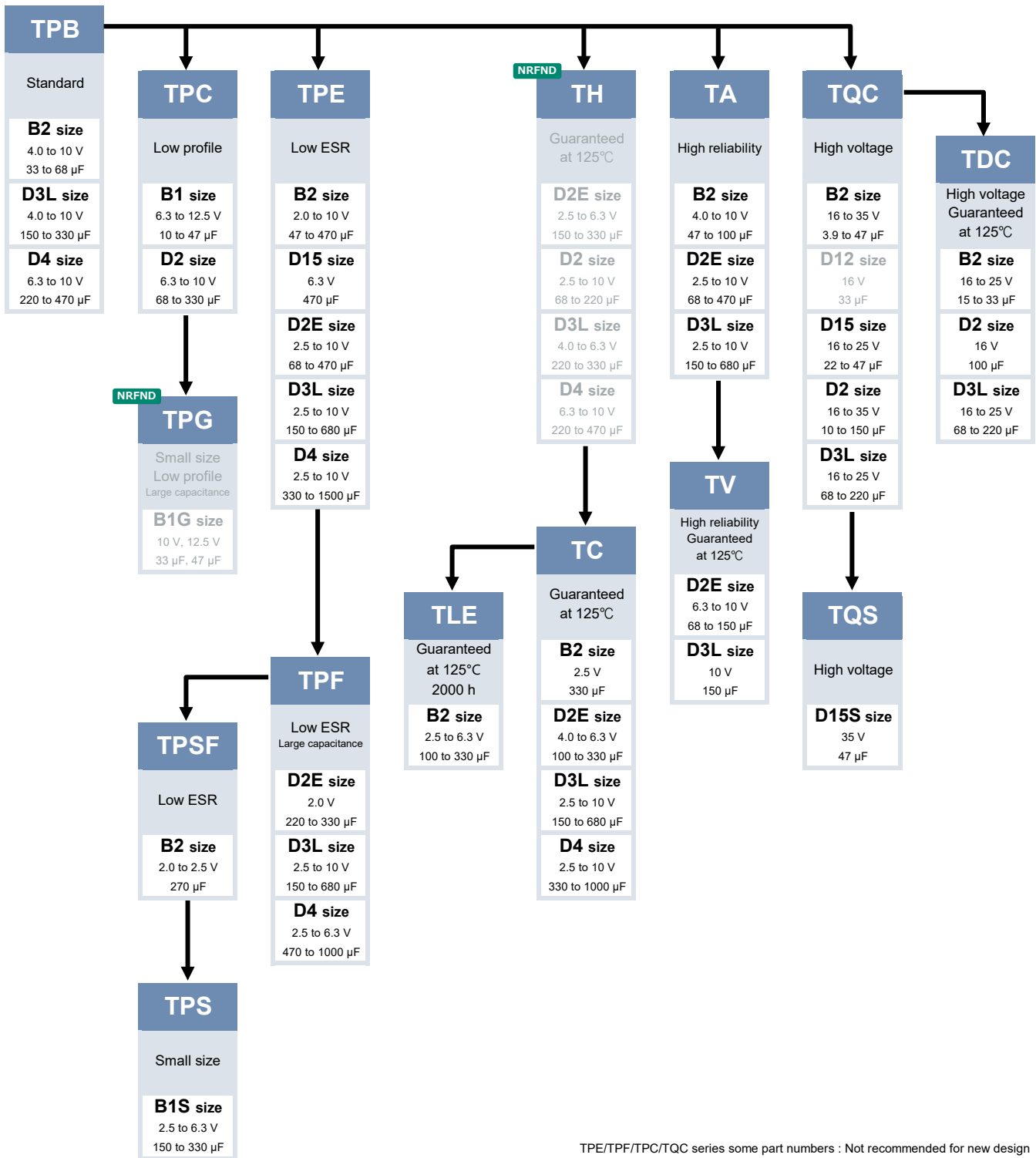

Voltage - Capacitance table (Vol. : 2.0 to 8.0 V / Cap. : 3.9 to 68 μ F)

Series [Size]
(ESR m Ω)

V_V / μ F	3.9	4.7	5.6	6.8	8.2	10	15	22	33	47	68
2.0											
2.5											
4.0											TPB [B2] (70)
6.3										TA [B2] (70)	TA [B2] (70)
									TPB [B2] (70)	TPC [B1] (70,55)	TPB [B2] (70)
8.0								TPC [B1] (70)			

Size list LxWxH (mm)

B1	3.5x2.8x1.1	B2	3.5x2.8x1.9	D15	7.3x4.3x1.4	D2E	7.3x4.3x1.8	D3L	7.3x4.3x2.8
B1S	3.5x2.8x1.1	B2S	3.5x2.8x1.9	D15E	7.3x4.3x1.4	D2	7.3x4.3x1.9	D4	7.3x4.3x3.8
				D15S	7.3x4.3x1.4				

Voltage - Capacitance table (Vol. : 2.0 to 8.0 V / Cap. : 100 to 1500 μF)

Series [Size]
(ESR mΩ)

V	μF	100	120	150	220	270	330	470	680	1000	1500
2.0						TPSF [B2S] (9,6)		TPE [B2] (15,11)			
					TPS [B1S] (30)	TPSF [B2S] (6)	TPS [B1S] (30)	TPE [D2E] (18,15,12,9,7)	TPE [D3L] (40,15,12)	TPE [D4] (15)	TPE [D4] (15,12)
2.5					TPE [B2] (35,30,25,21,15)		TPE [B2] (35,18,9)	TPF [D3L] (10,7,6)	TPF [D3L] (10,9,7,6)	TPF [D4] (6,5)	
					TPE [D2E] (18,15,9)		TPE [D2E] (18,15,12,9,7)	TPF [D4] (5)	TPF [D4] (25,5)	TC [D4] (15,6,5)	
					TA [D2E] (25,15,9)		TPF [D3L] (7)	TA [D2E] (25,15)	TA [D3L] (25,15)		
							TA [D2E] (25,18,15)		TC [D3L] (15,12,10,7,6,5)		
							TC [B2] (9)		TC [D4] (5)		
							TLE [B2] (12)				
4.0		TPE [B2] (70,40,35)		TPE [B2] (35)	TPS [B1S] (35,30)		TPE [D2E] (40,25,18)	TPE [D3L] (40,25,18,15,12)	TPF [D4] (35,15,10)		
		TA [B2] (70)		TPE [D2E] (18)	TPE [B2] (70,45,35)		TPF [D3L] (15,12,9)	TPF [D3L] (10)	TC [D4] (10)		
				TC [D2E] (18)	TPE [D2E] (45,25,18,15)		TPB [D3L] (40)	TA [D3L] (25,18)			
					TA [D2E] (25,18)		TC [D2E] (25,18)	TC [D3L] (25,18,15,12,10)			
					TC [D2E] (25,18,15)		TC [D3L] (12)				
6.3		TPE [B2] (70,45,40,35,25)	TPE [B2] (35)	TPS [B1S] (35,30)	TPE [B2] (70,45,35,25)		TPE [D2E] (25)	TPE [D4] (40,35,25,18)	TPE [D4] (25,18)		
		TPE [D2E] (45,25,18)		TPE [B2] (35,25)	TPE [D2E] (40,25,18)		TPE [D3L] (25,18,15)	TPF [D4] (15,10)	TC [D4] (25,18)		
		TLE [B2] (35)		TPE [D2E] (25,18,15)	TPE [D3L] (18)		TPE [D4] (10)	TPB [D4] (35)			
				TPF [D3L] (25)	TPF [D3L] (25,15,12,9,6)		TPF [D3L] (10,9)	TC [D4] (25,18,10)			
				TA [D2E] (25)	TA [D2E] (25,18)		TA [D3L] (25)				
				TV [D2E] (25)	TPB [D3L] (50,40)		TPB [D3L] (45,40)				
				TPC [D2] (40)	TPB [D3L] (40)		TPB [D4] (40)				
				TC [D2E] (25,18,15)	TC [D2E] (25,18)		TPC [D2] (40)				
					TC [D3L] (12,9,5)		TC [D3L] (25,18,15,9)				
					TC [D3L] (12,9,5)						
8.0		TPE [B2] (35)		TPC [D2] (40)							

Size list LxWxH (mm)

B1	3.5x2.8x1.1	B2	3.5x2.8x1.9	D15	7.3x4.3x1.4	D2E	7.3x4.3x1.8	D3L	7.3x4.3x2.8
B1S	3.5x2.8x1.1	B2S	3.5x2.8x1.9	D15E	7.3x4.3x1.4	D2	7.3x4.3x1.9	D4	7.3x4.3x3.8
				D15S	7.3x4.3x1.4				

Voltage - Capacitance table (Vol. : 10 to 35 V / Cap. : 3.9 to 68 μ F)

Series [Size]
(ESR m Ω)

V	μ F	3.9	4.7	5.6	6.8	8.2	10	15	22	33	47	68
10										TPB [B2] (70)	TPE [B2] (35)	TPE [D2E] (40,25)
											TA [B2] (70)	TA [D2E] (25)
											TPB [B2] (70)	TV [D2E] (25)
												TPC [D2] (100,60,45)
12.5						TPC [B1] (80)	TPC [B1] (80)					
16							TQC [B2] (100)	TQC [B2] (90)	TQC [B2] (90)	TQC [B2] (90)	TQC [B2] (90)	TQC [D2] (50)
										TQC [D12] (40)	TQC [D15] (55)	
										TQC [D2] (70)	TQC [D2] (70,55,40)	
										TDC [B2] (90)		
20						TQC [B2] (100)			TQC [B2] (90)	TQC [D2] (60)	TQC [D15] (55)	
									TQC [D2] (90)		TQC [D2] (55)	
									TDC [B2] (90)			
25			TQC [B2] (100)				TQC [B2] (100)	TQC [B2] (100)	TQC [B2] (100)	TQC [D2] (60)		TQC [D3L] (70)
								TQC [D2] (90,45)	TQC [D15] (70)			TDC [D3L] (70)
								TDC [B2] (100)	TQC [D2] (60,45)			
35	TQC [B2] (400)						TQC [B2] (200,150)	TQC [D2] (150)			TDC [D15S] (100)	
							TQC [D2] (120)					

Size list LxWxH (mm)

B1	3.5x2.8x1.1	B2	3.5x2.8x1.9	D15	7.3x4.3x1.4	D2E	7.3x4.3x1.8	D3L	7.3x4.3x2.8
B1S	3.5x2.8x1.1	B2S	3.5x2.8x1.9	D15E	7.3x4.3x1.4	D2	7.3x4.3x1.9	D4	7.3x4.3x3.8
				D15S	7.3x4.3x1.4				

Voltage - Capacitance table (Vol. : 10 to 35 V / Cap. : 100 to 1500 μ F)

Series [Size]
(ESR m Ω)

V	μ F	100	120	150	220	270	330	470	680	1000	1500
10		TPC [D2] (55,50,45)		TPE [D3L] (25)	TPE [D3L] (25,18)		TPE [D4] (25)				
				TPF [D3L] (15)	TA [D3L] (25)		TPB [D4] (40,35)				
				TA [D3L] (25)	TPB [D3L] (40)		TC [D4] (25)				
				TV [D3L] (25)	TPB [D4] (40)						
				TPB [D3L] (55,40)	TC [D3L] (25,18)						
				TC [D3L] (15)							
12.5											
16		TQC [D2] (50)		TQC [D2] (50)	TQC [D3L] (50)						
		TDC [D2] (50)		TQC [D3L] (50)							
20		TQC [D2] (100)									
		TQC [D3L] (55)									
		TDC [D3L] (55)									
25		TQC [D3L] (60)									
35											

Size list LxWxH (mm)

B1	3.5x2.8x1.1	B2	3.5x2.8x1.9	D15	7.3x4.3x1.4	D2E	7.3x4.3x1.8	D3L	7.3x4.3x2.8
B1S	3.5x2.8x1.1	B2S	3.5x2.8x1.9	D15E	7.3x4.3x1.4	D2	7.3x4.3x1.9	D4	7.3x4.3x3.8
				D15S	7.3x4.3x1.4				

Explanation of part numbers

◇ Part number system

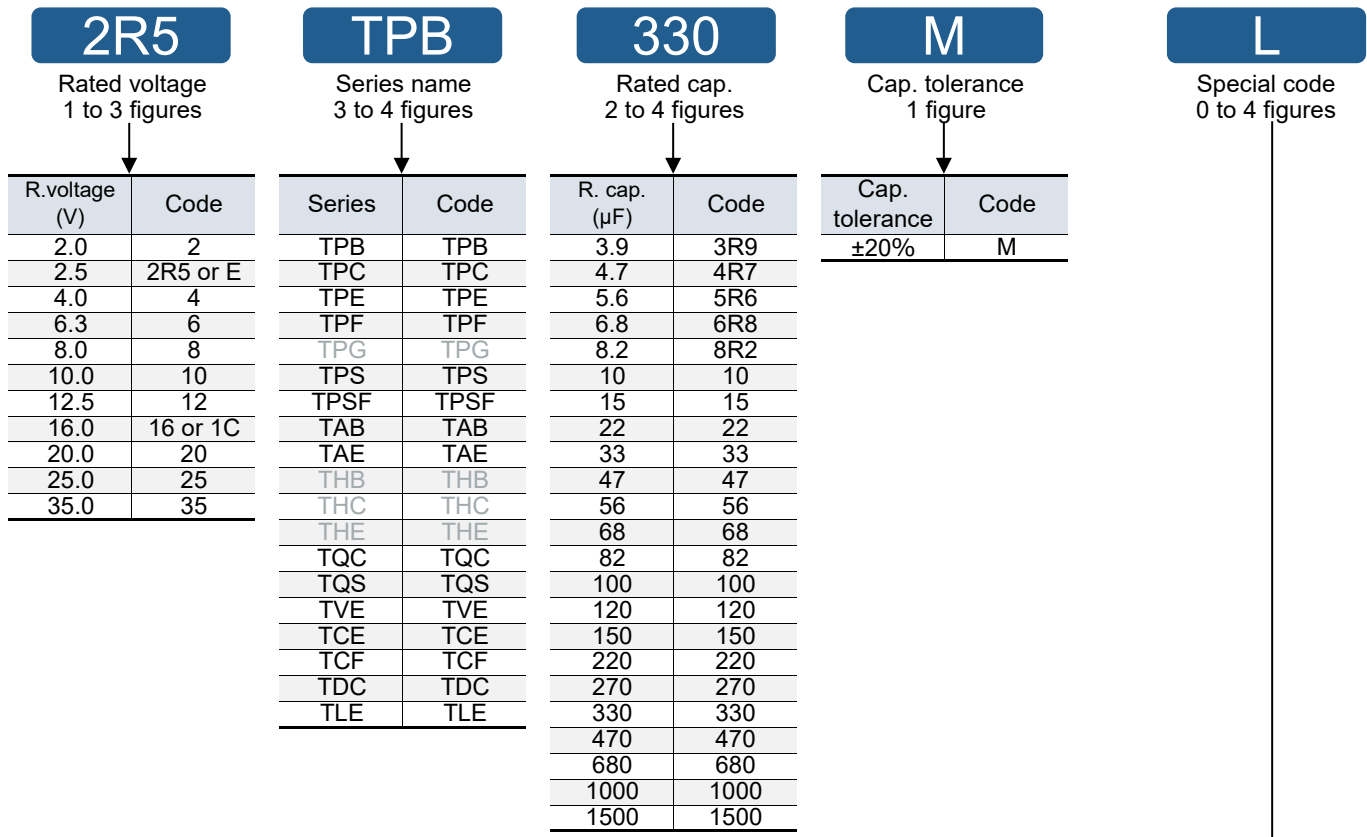

Standard		Code
TPE series		
B2	ESR 35 mΩ max.	ZB
	ESR 25 mΩ max.	PB
	ESR 21 mΩ max.	LB
	ESR 15 mΩ max.	FB
	ESR 15 mΩ / 300 kHz max.	FGB
	ESR 35 mΩ max. 85°C	AZB
	ESR 25 mΩ max. 85°C	APB
	ESR 15 mΩ max. 85°C	AFB
	ESR 13 mΩ / 300 kHz max. 85°C	ADGB
	ESR 11 mΩ / 300 kHz max. 85°C	AJGB
D15E	ESR 35 mΩ max. 85°C	AZU
D2E	ESR 25 mΩ max. 85°C	AP
D3L	ESR 25 mΩ max.	L
	ESR 18 mΩ max.	IL
	ESR 15 mΩ max.	FL
	ESR 12 mΩ max.	CL
	ESR 10 mΩ max.	AL
	ESR 25 mΩ max. 85°C	AL
	ESR 9 mΩ / 500 kHz max. 85°C	A9EL
NRFND TPG series		
B1G	ESR 35 mΩ / 300 kHz max.	ZGD
TPB series		
D3L		L
TPC series		
85 °C		A
B1		B
TQS series		
D15S	ESR 100 mΩ / Height 1.5 mm max.	EU
TLE series		
B2	ESR 35 mΩ max.	ZB
	ESR 12 mΩ / 300 kHz max.	CGB

Standard		Code
TPF series		
D3L	ESR 9 mΩ max.	9L
	ESR 7 mΩ max.	7L
	ESR 6 mΩ max.	6L
	ESR 5 mΩ max.	5L
D4	ESR 10 mΩ max.	AH
	ESR 6 mΩ max.	6H
	ESR 5 mΩ max.	5H
TQC / TDC series		
Capacitance enlarged type		YF
Capacitance enlarged type (B2 size)		YFB
Capacitance enlarged type (D12 size)		YFS
Capacitance enlarged type (D15 size)		YFT
Capacitance enlarged type (D2 size)		YFD/D2
Capacitance enlarged type (D3L size)		D3
All series		
ESR 55 mΩ max.		G
ESR 45 mΩ max.		V
ESR 40 mΩ max.		W
ESR 35 mΩ max.		Z
ESR 18 mΩ max.		I
ESR 15 mΩ max.		F
ESR 12 mΩ max.		C
ESR 9 mΩ max.		9
ESR 7 mΩ max.		7
ESR 6 mΩ max.		6
ESR 5 mΩ max.		5
ESR 35 mΩ / 300 kHz max.		ZG
ESR 30 mΩ / 300 kHz max.		UG
ESR 9 mΩ / 300 kHz max.		9G
ESR 6 mΩ / 500 kHz max.		6E
ESR 4 mΩ / 500 kHz max.		4E

TPE/TPF/THC/TPC/TQC series some part numbers : Not recommended for new design
NRFND Not recommended for new design

Mounting specifications

◆ **Recommendable reflow soldering**

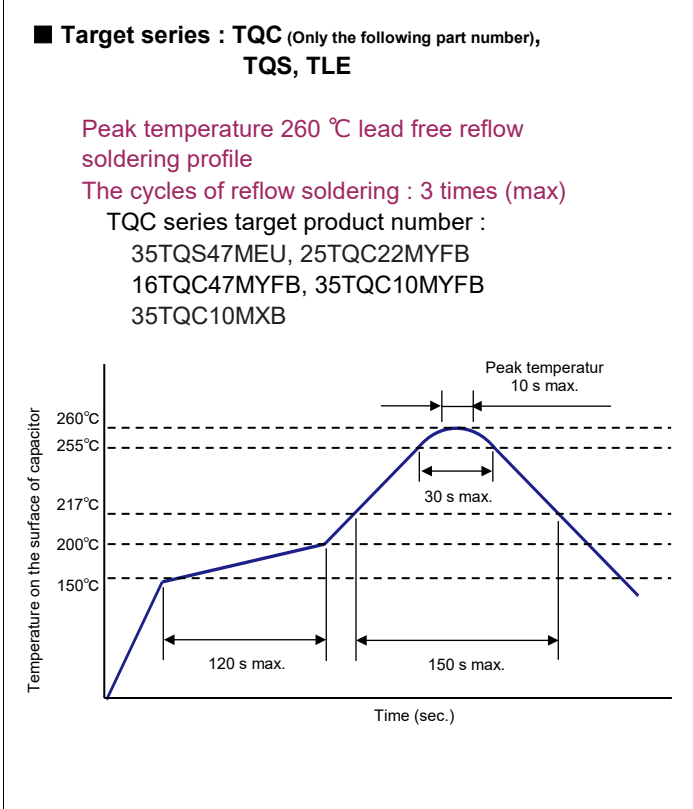
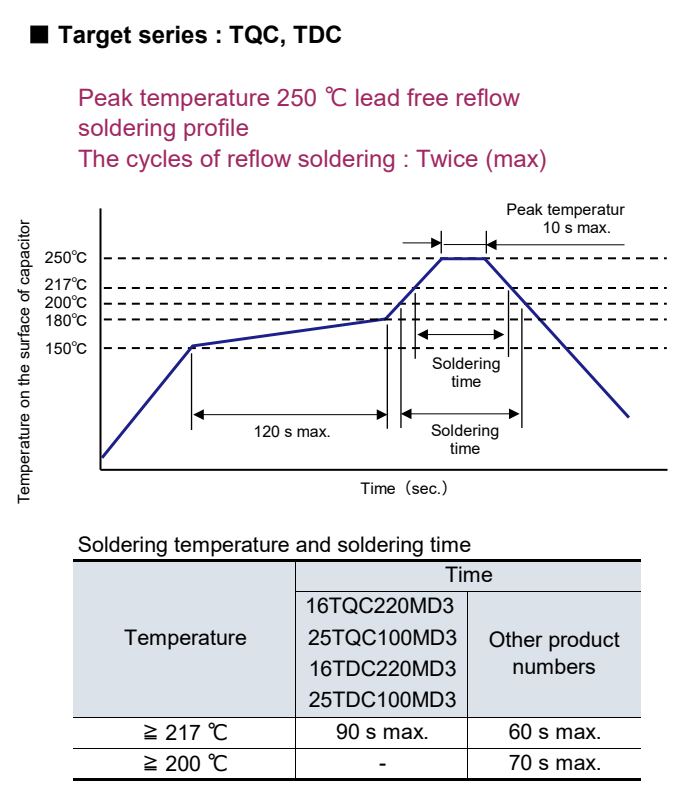
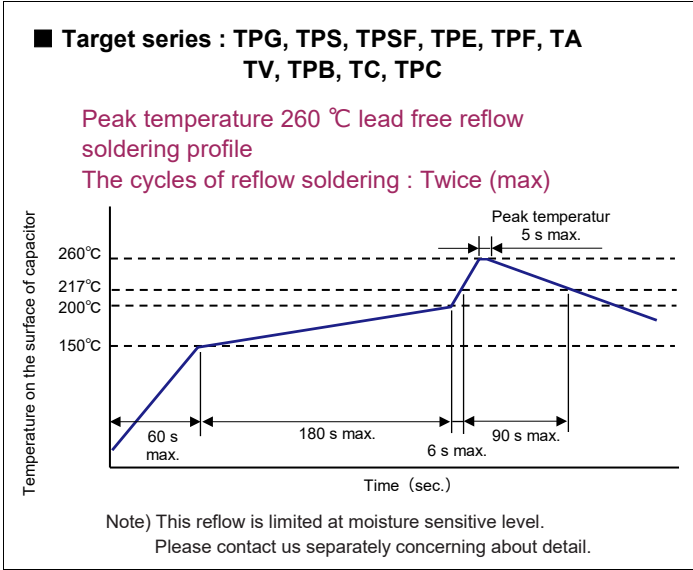
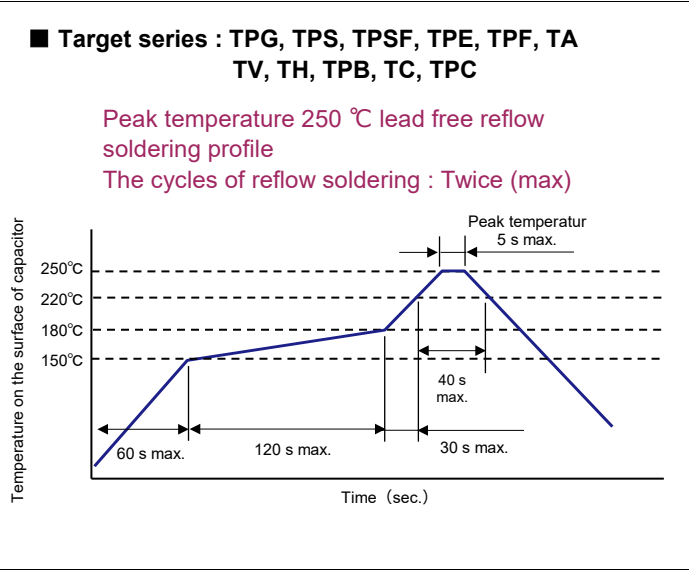

● **Soldering with a soldering iron**

- Tip of a soldering iron : 350 °C max (TQC / TQS series : 400 °C max.)
- Power of a soldering iron : 30 W max.
- Working time : 3 sec. max. (TQC / TQS series : 5 sec. max.)

(Do not let the tip of soldering iron touch the POSCAP itself. Do not subject the POSCAP itself to excessive stress when soldering)

Land pattern

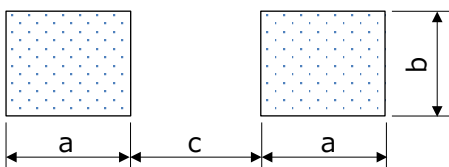

Size code	Unit : mm		
	a	b	c
B1, B1S, B1G, B15G, B2, B2S	1.6	2.7	1.4
D12, D15, D15E, D2E, D2, D3L, D4	2.4	2.9	3.7
D15S	1.4 / 1.7 ^{*1}	2.6	4.6

B1G, B15G, D12 size : Not recommended for new design

*1 : +side / -side

Packing specifications

◇ Dimension of carrier tape

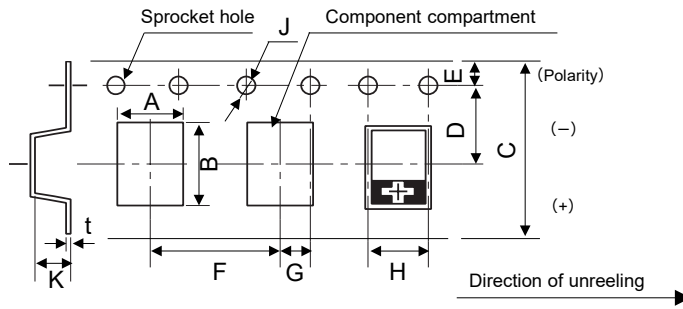

Unit : mm

Size code	A±0.1	B±0.1	C±0.3	D±0.05	E±0.1	F±0.1	G±0.05	H±0.1	J $\begin{smallmatrix} +0.1 \\ -0.1 \end{smallmatrix}$	K±0.1	t±0.05
B1	3.2	3.8	8.0	3.5	1.75	4.0	2.0	4.0	∅1.5	1.4	0.25
B1S	3.25	3.9	8.0	3.5	1.75	4.0	2.0	4.0	∅1.5	1.7	0.25
B1G	3.25	3.9	8.0	3.5	1.75	4.0	2.0	4.0	∅1.5	1.7	0.25
B2	3.3	3.8	8.0	3.5	1.75	4.0	2.0	4.0	∅1.5	2.1	0.25
B2S	3.25	4.0	8.0	3.5	1.75	4.0	2.0	4.0	∅1.5	2.1	0.25
D12	4.5	7.5	12.0	5.5	1.75	8.0	2.0	4.0	∅1.5	1.7	0.3
D15	4.5	7.5	12.0	5.5	1.75	8.0	2.0	4.0	∅1.5	2.4	0.3
D15E, D15S	4.7	7.8	12.0	5.5	1.75	8.0	2.0	4.0	∅1.5	1.7	0.3
D2E	4.5	7.5	12.0	5.5	1.75	8.0	2.0	4.0	∅1.5	2.4	0.3
D2	4.5	7.5	12.0	5.5	1.75	8.0	2.0	4.0	∅1.5	2.4	0.3
D3L	4.5	7.7	12.0	5.5	1.75	8.0	2.0	4.0	∅1.5	3.2	0.3
D4	4.5	7.7	12.0	5.5	1.75	8.0	2.0	4.0	∅1.5	4.2	0.3

- Dimension A and B are the measure of compartment's inside bottom.
- The (+) Polarity of the chip is placed on right side towards the unreeling direction.
- Dimension of the topcover tape.
Thickness of cover tape : 62±10 μm, Width of cover tape : 9.5±0.2 mm 5.5±0.2 mm (∅180)

B1G, D12 size : Not recommended for new design

◇ Reel dimension

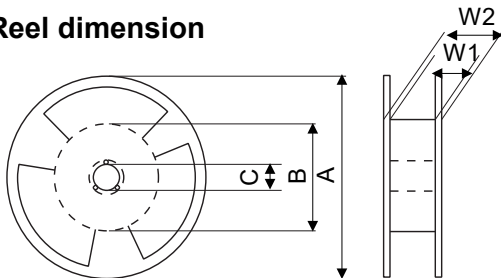

Unit : mm

A	B	C	W1	W2
∅330±2	∅80±2	∅13.0±0.2	13.5±0.5	17.5±1.0
∅180 $\begin{smallmatrix} 0 \\ -3 \end{smallmatrix}$	∅60±2	∅13.0±0.2	9.0±0.5	11.4±1.0

◇ Minimum packing quantity and weight

(∅180)

Size code	Qty. (pcs./Reel)	Typical weight (g)
B1	3000	200
B1S, B1G	2500	200
B2, B2S	2000	200

(∅330)

Size code	Qty. (pcs./Reel)	Typical weight (g)
D12	4500	1200
D15	3000	1000
D15E, D15S	4000	1000
D2E, D2	3000	1000
D3L	2500	1100
D4	2000	1200

※ Small order quantity (500 pcs/reel) is available with TPE, TPF and TQC series.
Please contact our sales representative if you prefer it.

B1G, D12 size : Not recommended for new design

◇ Dimension of packing case

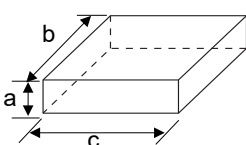

Unit : mm

Reel size	∅180	∅330
a	90	120
b	240	360
c	240	360

◇ Units per packing case

Size code	Pieces/case	Size code	Pieces/case
B1	15000	D12	22500
B1S, B1G	12500	D15	15000
B2, B2S	10000	D15E, D15S	20000
		D2E, D2	15000
		D3L	12500
		D4	10000

B1G, D12 size

: Not recommended for new design



Conductive Polymer Tantalum Solid Capacitors

Surface Mount Type

TLE series

Features

- 125 °C 2000 h
- Small size (L 3.5 × W 2.8 × H 1.9 mm)
- RoHS compliance, Halogen free

Specifications

Size code	B2	
Category temp. range	-55 °C to +125 °C	
Rated volt. range	2.5 V to 6.3 V	
Category volt. range	2.0 V to 5.0 V	
Rated cap. range	100 μF to 330 μF	
Capacitance tolerance	±20 % (120 Hz / +20 °C)	
Leakage current	Please see the attached characteristics list	
Dissipation factor(tan δ)	Please see the attached characteristics list	
Surge voltage (V)	Rated voltage × 1.15	
Endurance	+125 °C 2000 h category voltage applied	
	Capacitance change	Within ±20 % of the initial value
	Dissipation factor(tan δ)	≤ 1.5 times of the initial limit
	Leakage current	≤ 3 times of the initial limit
Damp heat (Steady State)	+60 °C, 90 % to 95 % RH, 500 h, No-applied voltage	
	Capacitance change	Within +40 % (ETLE330MCGB: +50 %) , -20 % of the initial value
	Dissipation factor(tan δ)	≤ 1.5 times of the initial limit
	Leakage current	≤ 3 times of the initial limit

Marking

Rated voltage code

Polarity marking (+)

Rated capacitance code

Lot. No.

R.voltage code	Unit : V	R.capacitance code	Unit : μF
e	2.5	A8	100
j	6.3	N8	330

Dimensions (not to scale)

Size code	L±0.2	W±0.2	H±0.1	S±0.2	W1±0.1
B2	3.5	2.8	1.9	0.8	2.2

Unit : mm

* Externals of figure are the reference.

Characteristics list

Rated voltage (V)	Rated temperature (°C)	Category voltage (V)	Category temperature (°C)	Rated capacitance (μF)	Case size (mm)			Size code	Specifications				Standard		Floor life level	
					L	W	H		Ripple current ^{*1} (mA rms)	ESR ^{*2} (mΩ max.)	tan δ ^{*3}	LC ^{*4} (μA)	Part number	Min. packaging q'ty (pcs)	Reflow temp ≤260°C	Reflow temp ≤250°C
2.5	105	2.0	125	330	3.5	2.8	1.9	B2	2770	12 / 300kHz	0.08	165.0	ETLE330MCGB	2000	3	3
6.3	105	5.0	125	100	3.5	2.8	1.9		1400	35	0.08	126.0	6TLE100MZB	2000		

*1: Ripple current (100 kHz / +45 °C)

*2: ESR (100 kHz / +20 °C)

*3: tan δ (120 Hz / +20 °C)

*4: After 5 minutes

◆ Please refer to each page in this catalog for "Reflow conditions", "Taping specifications" and "Floor life level".

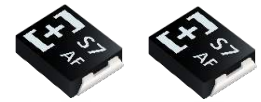

Conductive Polymer Tantalum

Solid Capacitors

Surface Mount Type

TPG series

Features

- Small size, Low profile (L 3.5 × W 2.8 × H 1.1 mm)
- RoHS compliance, Halogen free

Specifications

Size code	B1G	
Category temp. range	-55 °C to +105 °C	
Rated volt. range	10.0 V, 12.5 V	
Category volt. range	8.0 V, 10.0 V	
Rated cap. range	33 μF, 47 μF	
Capacitance tolerance	±20 % (120 Hz / +20 °C)	
Leakage current	Please see the attached characteristics list	
Dissipation factor(tan δ)	Please see the attached characteristics list	
Surge voltage (V)	Rated voltage × 1.15	
Endurance	+85 °C 1000 h rated voltage applied	
	Capacitance change	Within ±20 % of the initial value
	Dissipation factor(tan δ)	≤ 1.5 times of the initial limit
Damp heat (Steady State)	+60 °C, 90 % to 95 % RH, 500 h, No-applied voltage	
	Capacitance change	Within +40 %, -20 % of the initial value
	Dissipation factor(tan δ)	≤ 1.5 times of the initial limit
	Leakage current	≤ 3 times of the initial limit

Marking

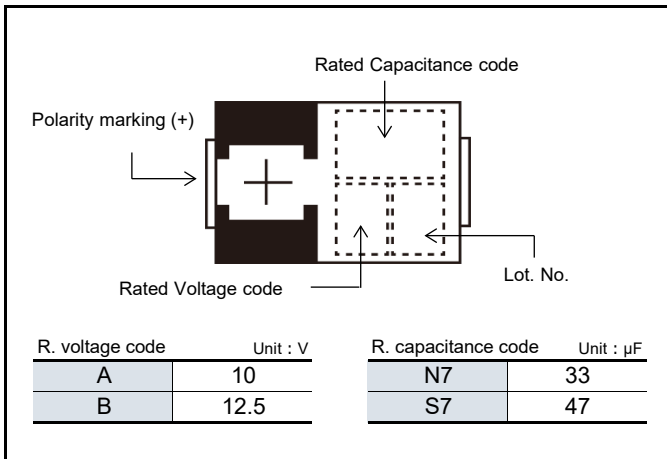

Dimensions (not to scale)

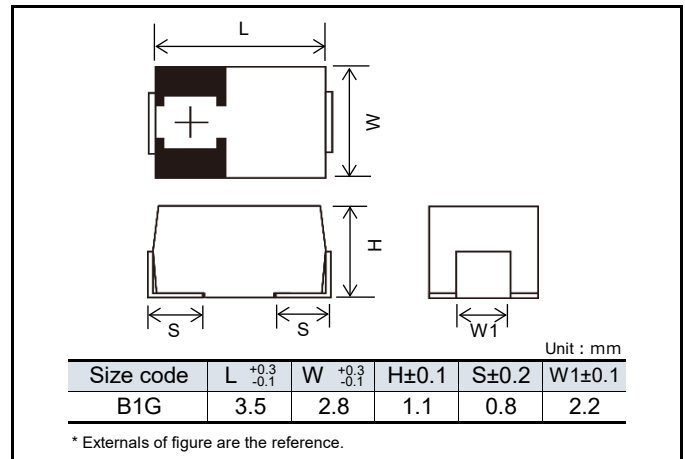

Characteristics list

Rated voltage (V)	Rated temperature (°C)	Category voltage (V)	Category temperature (°C)	Rated capacitance (μF)	Case size (mm)			Size code	Specifications				Standard		Floor life level	
					L	W	H		Ripple current ^{*1} (mA rms)	ESR ^{*2} (mΩ max.)	tan δ ^{*3}	LC ^{*4} (μA)	Part number ^{*5}	Min. packaging q'ty (pcs)	Reflow temp ≤260°C	Reflow temp ≤250°C
10	85	8.0	105	47	3.5	2.8	1.1	B1G	1000	70	0.10	47	10TPG47M	2500	3	3
12.5	85	10	105	33	3.5	2.8	1.1		1000	70	0.10	41.3	12TPG33M	2500		

*1: Ripple current (100 kHz / +45 °C)

*2: ESR (100 kHz / +20 °C)

*3: tan δ (120 Hz / +20 °C)

*4: After 5 minutes

*5: Compatible products available

◆ Please refer to each page in this catalog for "Reflow conditions", "Taping specifications" and "Floor life level".

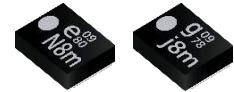

Conductive Polymer Tantalum Solid Capacitors

Surface Mount Type

TPS series

Features

- 105 °C 2000 h
- Small size, Low profile (L 3.5 × W 2.8 × H 1.2 mm max.)
- RoHS compliance, Halogen free

Specifications

Size code	B1S	
Category temp. range	-55 °C to +105 °C	
Rated volt. range	2.5 V to 6.3 V	
Category volt. range	2.5 V to 6.3 V	
Rated cap. range	150 μF to 330 μF	
Capacitance tolerance	±20 % (120 Hz / +20 °C)	
Leakage current	Please see the attached characteristics list	
Dissipation factor(tan δ)	Please see the attached characteristics list	
Surge voltage (V)	Rated voltage × 1.15	
Endurance	+105 °C 2000 h rated voltage applied	
	Capacitance change	Within ±20 % of the initial value
	Dissipation factor(tan δ)	≤ 1.5 times of the initial limit
	Leakage current	Within the initial limit
Damp heat (Steady State)	+60 °C, 90 % to 95 % RH, 500 h, No-applied voltage	
	Capacitance change	Within +40 %, -20 % of the initial value
	Dissipation factor(tan δ)	≤ 1.5 times of the initial limit
	Leakage current	≤ 3 times of the initial limit

Marking

Rated voltage code

Polarity marking (+)

Rated capacitance code

Lot. No.

R.voltage code	Unit : V	R.capacitance code	Unit : μF
e	2.5	E8	150
g	4.0	J8	220
j	6.3	N8	330

Dimensions (not to scale)

Size code	L±0.2	W±0.2	H±0.1	S±0.3	W1±0.1
B1S	3.5	2.8	1.1	0.8	2.2

Unit : mm

* Externals of figure are the reference.

Characteristics list

Rated voltage (V)	Rated temperature (°C)	Category voltage (V)	Category temperature (°C)	Rated capacitance (μF)	Case size (mm)			Size code	Specifications				Standard		Floor life level	
					L	W	H		Ripple current ^{*1} (mA rms)	ESR ^{*2} (mΩ max.)	tan δ ^{*3}	LC ^{*4} (μA)	Part number	Min. packaging qty (pcs)	Reflow temp ≤260°C	Reflow temp ≤250°C
2.5	105	2.5	105	220	3.5	2.8	1.1	B1S	1400	30	0.10	55.0	ETPS220MUD	2500	3	3
	105	2.5	105	330	3.5	2.8	1.1		1400	30	0.10	82.5	ETPS330MUD	2500		
4.0	105	4.0	105	220	3.5	2.8	1.1		1400	30	0.10	88.0	4TPS220MUD	2500		
	105	6.3	105	150	3.5	2.8	1.1		1400	30	0.10	94.5	6TPS150MUD	2500		
6.3	105	6.3	105		3.5	2.8	1.1		1250	35	0.10	94.5	6TPS150MZD	2500		

*1: Ripple current (100 kHz / +45 °C)

*2: ESR (100 kHz / +20 °C)

*3: tan δ (120 Hz / +20 °C)

*4: After 5 minutes

◆ Please refer to each page in this catalog for "Reflow conditions", "Taping specifications" and "Floor life level".

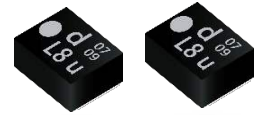

Conductive Polymer Tantalum Solid Capacitors

Surface Mount Type

TPSF series

Features

- Super low ESR (6 mΩ max.)
- Super low ESL (0.7 nH max.)
- Face down terminal type
- RoHS compliance, Halogen free

Specifications

Size code	B2S	
Category temp. range	-55 °C to +105 °C	
Rated volt. range	2.0 V to 2.5 V	
Category volt. range	2.0 V to 2.5 V	
Rated cap. range	270 μF	
Capacitance tolerance	±20 % (120 Hz / +20 °C)	
Leakage current	Please see the attached characteristics list	
Dissipation factor(tan δ)	Please see the attached characteristics list	
Surge voltage (V)	Rated voltage × 1.15	
Endurance	+105 °C 1000 h rated voltage applied	
	Capacitance change	Within ±20 % of the initial value
	Dissipation factor(tan δ)	≤ 1.5 times of the initial limit
	Leakage current	Within the initial limit
Damp heat (Steady State)	+60 °C, 90 % to 95 % RH, 500 h, No-applied voltage	
	Capacitance change	Within +40 %, -20 % of the initial value
	Dissipation factor(tan δ)	≤ 1.5 times of the initial limit
	Leakage current	≤ 3 times of the initial limit

Marking

Rated voltage code

Polarity marking (+)

Rated capacitance code

Lot. No.

R.voltage code	Unit : V
d	2.0
e	2.5

R.capacitance code	Unit : μF
L8	270

Dimensions (not to scale)

	Unit : mm				
Size code	L±0.2	W±0.2	H±0.1	S±0.3	W1±0.1
B2S	3.5	2.8	1.9	0.8	2.2

* Externals of figure are the reference.

Characteristics list

Rated voltage (V)	Rated temperature (°C)	Category voltage (V)	Category temperature (°C)	Rated capacitance (μF)	Case size (mm)			Size code	Specifications				Standard		Floor life level	
					L	W	H		Ripple ^{*1} current (mA rms)	ESR ^{*2} (mΩ max.)	tan δ ^{*3}	LC ^{*4} (μA)	Part number	Min. packaging q'ty (pcs)	Reflow temp ≤260°C	Reflow temp ≤250°C
2.0	105	2.0	105	270	3.5	2.8	1.9	B2S	3200	6/500 kHz	0.08	108.0	2TPSF270M6E	2000	5	5
	105	2.0	105		3.5	2.8	1.9		2400	9/300 kHz	0.08	108.0	2TPSF270M9G	2000	3	3
2.5	105	2.5	105		3.5	2.8	1.9		3200	6/500 kHz	0.08	135.0	ETPSF270M6E	2000		

*1: Ripple current (100 kHz / +45 °C) *2: ESR (100 kHz / +20 °C) *3: tan δ (120 Hz / +20 °C) *4: After 5 minutes

◆ Please refer to each page in this catalog for "Reflow conditions", "Taping specifications" and "Floor life level".



Conductive Polymer Tantalum Solid Capacitors

Surface Mount Type

TPE series B size

Features

- Small size (L 3.5 × W 2.8 × H 1.9 mm)
- Low ESR (15 mΩ max.)
- RoHS compliance, Halogen free

Specifications

Size code	B2	
Category temp. range	-55 °C to +105 °C	
Rated volt. range	2.0 V to 10 V	
Category volt. range	1.8 V to 8 V	
Rated cap. range	47 μF to 470 μF	
Capacitance tolerance	±20 % (120 Hz / +20 °C)	
Leakage current	Please see the attached characteristics list	
Dissipation factor(tan δ)	Please see the attached characteristics list	
Surge voltage (V)	Rated voltage × 1.15	
Endurance	+105 °C 1000 h rated voltage applied	
	Rated temp, +85 °C Products : +85 °C 1000 h, rated voltage applied	
	Capacitance change	Within ±20 % of the initial value
	Dissipation factor(tan δ)	≤ 1.5 times of the initial limit
Damp heat (Steady State)	+60 °C, 90 % to 95 % RH, 500 h, No-applied voltage	
	Capacitance change	Within +50 %, -20 % of the initial value (2R5TPE220MAZB (MAPB, MAFB), 2R5TPE330MAZB, 2TPE470MAJGB (MAFB))
		Within +40 %, -20 % of the initial value (Except for above model)
	Dissipation factor(tan δ)	≤ 1.5 times of the initial limit
	Leakage current	≤ 3 times of the initial limit

Marking

Rated capacitance code

Polarity marking (+)

Rated voltage code

Lot No.

R. voltage code		Unit : V	
d	2.0	g	4.0
e	2.5	j	6.3
		k	8.0
		A	10

R. capacitance code		Unit : μF	
S7	47	E8	150
A8	100	J8	220
C8	120	N8	330
		S8	470

Dimensions (not to scale)

Size code	L±0.2	W±0.2	H±0.1	S±0.2	W1±0.1
B2	3.5	2.8	1.9	0.8	2.2

Unit : mm

* Externals of figure are the reference.

Characteristics list

Rated voltage (V)	Rated temperature (°C)	Category voltage (V)	Category temperature (°C)	Rated capacitance (μF)	Case size (mm)			Size code	Specifications				Standard		Floor life level		
					L	W	H		Ripple current (mA rms)	ESR* ² (mΩ max.)	tan δ* ³	LC* ⁴ (μA)	Part number	Min. packaging q'ty (pcs)	Reflow temp ≤260°C	Reflow temp ≤250°C	
2.0	85	1.8	105	470	3.5	2.8	1.9	B2	2300	15	0.10	188.0	2TPE470MAFB	2000	3	3	
	85	1.8	105		3.5	2.8	1.9		2300	11/300kHz	0.08	188.0	2TPE470MAJGB	2000			
2.5	85	2.0	105	220	3.5	2.8	1.9		2000	15	0.08	110.0	2R5TPE220MAFB	2000			
	105	2.5	105		3.5	2.8	1.9		1800	15/300kHz	0.08	110.0	2R5TPE220MFGB	2000			
	105	2.5	105		3.5	2.8	1.9		1700	21	0.08	55.0	2R5TPE220MLB	2000			
	85	2.0	105		3.5	2.8	1.9		1600	25	0.08	55.0	2R5TPE220MAPB	2000			
	105	2.5	105		3.5	2.8	1.9		1400	35	0.08	55.0	2R5TPE220MZB	2000			
	85	2.0	105		3.5	2.8	1.9		1400	35	0.08	55.0	2R5TPE220MAZB	2000			
	105	2.5	105		3.5	2.8	1.9		1400	30	0.08	55.0	2R5TPE220MUB	2000			
	85	2.0	105		330	3.5	2.8		1.9	1400	35	0.08	82.5	2R5TPE330MAZB			2000
	85	2.0	105			3.5	2.8		1.9	3200	9/300kHz	0.08	165.0	ETPE330MA9GB			2000
	105	2.5	105			3.5	2.8		1.9	3200	9/300kHz	0.08	165.0	ETPE330M9GB			2000
105	2.5	105	3.5	2.8		1.9	2700		15	0.08	165.0	ETPE330MFB	2000				
4.0	105	2.5	105	100	3.5	2.8	1.9		2450	18	0.08	165.0	ETPE330MIB	2000			
	105	4.0	105		3.5	2.8	1.9		1400	35	0.08	40.0	4TPE100MZB	2000			
	105	4.0	105		3.5	2.8	1.9		950	70	0.08	40.0	4TPE100MBB	2000			
	85	3.2	105		150	3.5	2.8		1.9	1300	40	0.08	40.0	4TPE100MWB			2000
	85	3.2	105		220	3.5	2.8		1.9	1400	35	0.08	60.0	4TPE150MAZB			2000
	105	4.0	105			3.5	2.8		1.9	1400	35	0.08	88.0	4TPE220MAZB			2000
	105	4.0	105			3.5	2.8		1.9	1350	35	0.10	88.0	4TPE220MZB			2000
	105	4.0	105			3.5	2.8	1.9	1150	45	0.10	88.0	4TPE220MVB	2000			
6.3	105	4.0	105	100	3.5	2.8	1.9	950	70	0.10	88.0	4TPE220MBB	2000				
	105	6.3	105		3.5	2.8	1.9	1600	25	0.08	63.0	6TPE100MPB	2000				
	85	5.0	105		3.5	2.8	1.9	1400	35	0.08	63.0	6TPE100MAZB	2000				
	105	6.3	105		3.5	2.8	1.9	1400	35	0.08	63.0	6TPE100MZB	2000				
	105	6.3	105		3.5	2.8	1.9	950	70	0.08	63.0	6TPE100MBB	2000				
	105	6.3	105		3.5	2.8	1.9	1300	40	0.08	63.0	6TPE100MWB	2000				
	105	6.3	105		3.5	2.8	1.9	1200	45	0.08	63.0	6TPE100MVB	2000				
	85	5.0	105		120	3.5	2.8	1.9	1400	35	0.08	75.6	6TPE120MAZB	2000			
	85	5.0	105		150	3.5	2.8	1.9	1600	25	0.08	94.5	6TPE150MAPB	2000			
	85	5.0	105			3.5	2.8	1.9	1400	35	0.08	94.5	6TPE150MAZB	2000			
	8.0	85	5.0		105	220	3.5	2.8	1.9	1400	35	0.10	138.6	6TPE220MAZB	2000		
		85	5.0		105		3.5	2.8	1.9	1600	25	0.10	138.6	6TPE220MAPB	2000		
		105	6.3		105		3.5	2.8	1.9	1150	45	0.10	138.6	6TPE220MVB	2000		
		105	6.3		105		3.5	2.8	1.9	950	70	0.10	138.6	6TPE220MBB	2000		
105		6.3	105	3.5	2.8		1.9	1350	35	0.10	138.6	6TPE220MZB	2000				
8.0		85	6.3	105	100		3.5	2.8	1.9	1400	35	0.08	80.0	8TPE100MAZB	2000		
10		85	8.0	105	47		3.5	2.8	1.9	1400	35	0.08	47.0	10TPE47MAZB	2000		

*1: Ripple current (100 kHz / +45 °C)

*2: ESR (100 kHz / +20 °C)

*3: tan δ (120 Hz / +20 °C)

*4: After 5 minutes

◆ Please refer to each page in this catalog for "Reflow conditions", "Taping specifications" and "Floor life level".

◆ Small order quantity (500 pcs/reel) is available with TPE series. Please contact our sales representative if you prefer it.



Conductive Polymer Tantalum Solid Capacitors

Surface Mount Type

TPE series D size

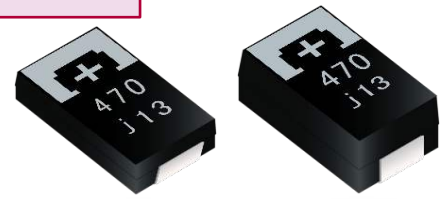

Features

- Low profile (Height 1.5 mm max.)
- Low ESR (7 mΩ max.)
- Large capacitance (1500 μF max.)
- RoHS compliance, Halogen free

Specifications

Size code	D15E	D2E	D3L	D4
Category temp. range	-55 °C to +105 °C			
Rated volt. range	6.3 V	2.5 V to 10 V		
Category volt. range	5.0 V	2.5 V to 10 V		
Rated cap. range	470 μF	68 μF to 470 μF	150 μF to 680 μF	330 μF to 1500 μF
Capacitance tolerance	±20 % (120 Hz / +20 °C)			
Leakage current	Please see the attached characteristics list			
Dissipation factor(tan δ)	Please see the attached characteristics list			
Surge voltage (V)	Rated voltage × 1.15			
Endurance	+105 °C 2000 h rated voltage applied			
	Rated temp, +85 °C Products : +85 °C 1000 h, rated voltage applied			
	(6TPE330MAP, 6TPE470MAZU : +85 °C 2000 h, rated voltage applied)			
	Capacitance change	Within ±20 % of the initial value		
Damp heat (Steady State)	Dissipation factor(tan δ)	≤ 1.5 times of the initial limit		
	Leakage current	Within the initial limit		
	Capacitance change	Within +50 %, -20 % of the initial value (2R5TPE220M (I, F, 9), 2R5TPE330M (I, F, C, 9, 7), 2R5TPE470M (I, F, C, 9, 7), 2R5TPE1000MF, 2R5TPE1500M (F, C))		
Damp heat (Steady State)	Dissipation factor(tan δ)	≤ 1.5 times of the initial limit		
	Leakage current	≤ 3 times of the initial limit		
	Capacitance change	Within +40 %, -20 % of the initial value (Except for above model)		

Marking

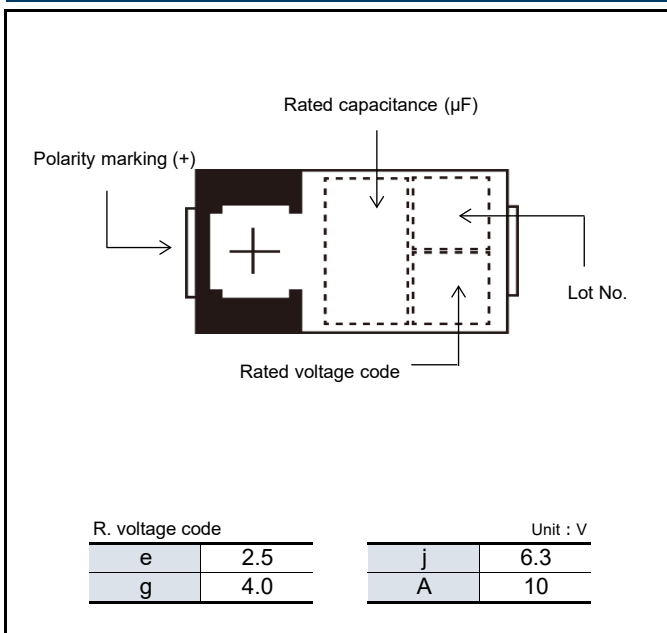

Dimensions (not to scale)

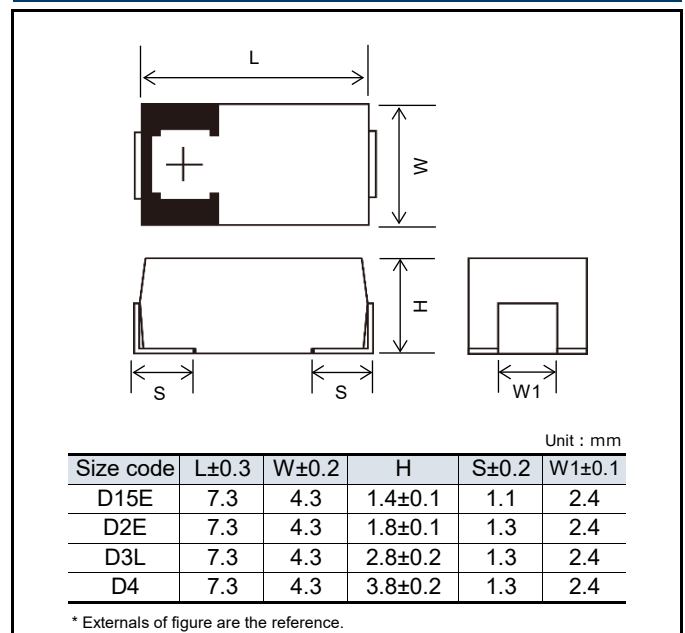

Characteristics list

Rated voltage (V)	Rated temperature (°C)	Category voltage (V)	Category temperature (°C)	Rated capacitance (μF)	Case size (mm)			Size code	Specifications				Standard		Floor life level					
					L	W	H		Ripple ^{*1} current (mA rms)	ESR ^{*2} (mΩ max.)	tan δ ^{*3}	LC ^{*4} (μA)	Part number	Min. packaging q'ty (pcs)	Reflow temp ≤260°C	Reflow temp ≤250°C				
2.5	105	2.5	105	220	7.3	4.3	1.8	D2E	3900	9	0.10	55.0	2R5TPE220M9	3000	3					
	105	2.5	105		7.3	4.3	1.8		3100	15	0.10	55.0	2R5TPE220MF	3000						
	105	2.5	105		7.3	4.3	1.8		2800	18	0.10	55.0	2R5TPE220MI	3000						
	NRFND 105	2.5	105		7.3	4.3	1.8		2400	25	0.10	55.0	2R5TPE220M	3000						
	105	2.5	105	330	7.3	4.3	1.8		4400	7	0.10	82.5	2R5TPE330M7	3000			3			
	105	2.5	105		7.3	4.3	1.8		3900	9	0.10	82.5	2R5TPE330M9	3000						
	105	2.5	105		7.3	4.3	1.8		3500	12	0.10	82.5	2R5TPE330MC	3000						
	105	2.5	105		7.3	4.3	1.8		3100	15	0.10	82.5	2R5TPE330MF	3000						
	105	2.5	105		7.3	4.3	1.8		2800	18	0.10	82.5	2R5TPE330MI	3000						
	NRFND 105	2.5	105		7.3	4.3	1.8		2400	25	0.10	82.5	2R5TPE330M	3000						
	105	2.5	105		7.3	4.3	1.8		4400	7	0.10	117.5	2R5TPE470M7	3000						
	105	2.5	105		7.3	4.3	1.8		3900	9	0.10	117.5	2R5TPE470M9	3000						
	105	2.5	105	470	7.3	4.3	1.8		3500	12	0.10	117.5	2R5TPE470MC	3000	3					
	105	2.5	105		7.3	4.3	1.8		3100	15	0.10	117.5	2R5TPE470MF	3000						
	105	2.5	105		7.3	4.3	1.8		2800	18	0.10	117.5	2R5TPE470MI	3000						
	105	2.5	105		7.3	4.3	1.8		3500	12	0.10	170.0	2R5TPE680MCL	2500						
	105	2.5	105	680	7.3	4.3	2.8		3100	15	0.10	170.0	2R5TPE680MFL	2500			3			
	105	2.5	105		7.3	4.3	2.8		1850	40	0.10	170.0	2R5TPE680MWL	2500						
	105	2.5	105		7.3	4.3	2.8		3900	15	0.15	250.0	2R5TPE1000MF	2000						
	105	2.5	105	1000	7.3	4.3	3.8		4400	12	0.15	375.0	2R5TPE1500MC	2000					-	
105	2.5	105	7.3		4.3	3.8	3900	15	0.15	375.0	2R5TPE1500MF	2000								
105	2.5	105	1500	7.3	4.3	3.8	3900	15	0.15	375.0	2R5TPE1500MF	2000	-							
105	2.5	105		7.3	4.3	3.8	3900	15	0.15	375.0	2R5TPE1500MF	2000								
105	4.0	105	150	7.3	4.3	1.8	2800	18	0.10	60.0	4TPE150MI	3000								
105	4.0	105	220	7.3	4.3	1.8	3100	15	0.10	88.0	4TPE220MF	3000								
105	4.0	105		7.3	4.3	1.8	2800	18	0.10	88.0	4TPE220MI	3000								
105	4.0	105		7.3	4.3	1.8	2400	25	0.10	88.0	4TPE220M	3000								
105	4.0	105		7.3	4.3	1.8	1750	45	0.10	88.0	4TPE220MV	3000								
105	4.0	105	330	7.3	4.3	1.8	2800	18	0.10	132.0	4TPE330MI	3000			3					
105	4.0	105		7.3	4.3	1.8	2400	25	0.10	132.0	4TPE330M	3000								
105	4.0	105		7.3	4.3	1.8	1850	40	0.10	132.0	4TPE330MW	3000								
105	4.0	105		7.3	4.3	1.8	3500	12	0.10	188.0	4TPE470MCL	2500								
105	4.0	105	470	7.3	4.3	2.8	3100	15	0.10	188.0	4TPE470MFL	2500					3			
105	4.0	105		7.3	4.3	2.8	2800	18	0.10	188.0	4TPE470MIL	2500								
105	4.0	105		7.3	4.3	2.8	2400	25	0.10	188.0	4TPE470MIL	2500								
105	4.0	105		7.3	4.3	2.8	2400	25	0.10	188.0	4TPE470ML	2500								
105	4.0	105	7.3	4.3	2.8	1850	40	0.10	188.0	4TPE470MWL	2500	-								
105	6.3	105	100	7.3	4.3	1.8	2800	18	0.10	63.0	6TPE100MI			3000						
105	6.3	105		7.3	4.3	1.8	2400	25	0.10	63.0	6TPE100M			3000						
105	6.3	105		7.3	4.3	1.8	1850	40	0.10	63.0	6TPE100MW			3000						
105	6.3	105		7.3	4.3	1.8	3100	15	0.10	94.5	6TPE150MF			3000						
105	6.3	105	150	7.3	4.3	1.8	2800	18	0.10	94.5	6TPE150MI			3000	3					
105	6.3	105		7.3	4.3	1.8	2400	25	0.10	94.5	6TPE150M			3000						
105	6.3	105		7.3	4.3	1.8	2800	18	0.10	138.6	6TPE220MI			3000						
105	6.3	105		7.3	4.3	1.8	2400	25	0.10	138.6	6TPE220M			3000						
85	5.0	105	220	7.3	4.3	1.8	2400	25	0.10	138.6	6TPE220MAP			3000			-			
105	6.3	105		7.3	4.3	1.8	1850	40	0.10	138.6	6TPE220MW			3000						
105	6.3	105	7.3	4.3	2.8	D3L 2800	18	0.10	138.6	6TPE220MIL	2500									
85	5.0	105	330	7.3	4.3	1.8	D2E 2400	25	0.10	207.9	6TPE330MAP	3000								
NRFND 85	5.0	105		7.3	4.3	2.8	3900	9/500kHz	0.10	207.9	6TPE330MA9EL	2500								
105	6.3	105	330	7.3	4.3	2.8	D3L 3100	15	0.10	207.9	6TPE330MFL	2500	3							
105	6.3	105		7.3	4.3	2.8	2800	18	0.10	207.9	6TPE330MIL	2500								
105	6.3	105		7.3	4.3	2.8	2400	25	0.10	207.9	6TPE330ML	2500								
85	5.0	105		7.3	4.3	3.8	D4 4400	10	0.10	207.9	6TPE330MAA	2000								
NRFND 85	5.0	105	7.3	4.3	1.4	D15E 1700	35	0.10	296.1	6TPE470MAZU	4000									
105	6.3	105	470	7.3	4.3	3.8	3500	18	0.15	296.1	6TPE470MI	2000			3					
105	6.3	105		7.3	4.3	3.8	3000	25	0.15	296.1	6TPE470M	2000								
105	6.3	105		7.3	4.3	3.8	2500	35	0.15	296.1	6TPE470MZ	2000								
105	6.3	105		7.3	4.3	3.8	2350	40	0.15	296.1	6TPE470MW	2000								
105	6.3	105	680	7.3	4.3	3.8	3500	18	0.15	428.4	6TPE680MI	2000					-			
105	6.3	105		7.3	4.3	3.8	3000	25	0.15	428.4	6TPE680M	2000								
105	10	105	68	7.3	4.3	1.8	D2E 2400	25	0.10	68.0	10TPE68M	3000							3	
105	10	105		7.3	4.3	1.8	1850	40	0.10	68.0	10TPE68MW	3000								
105	10	105	150	7.3	4.3	2.8	2400	25	0.10	150.0	10TPE150MPL	2500								
105	10	105		7.3	4.3	2.8	D3L 2800	18	0.10	220.0	10TPE220MIL	2500								
105	10	105	220	7.3	4.3	2.8	2400	25	0.10	220.0	10TPE220ML	2500	-	2a						
105	10	105		7.3	4.3	2.8	D4 3000	25	0.10	330.0	10TPE330M	2000								

*1: Ripple current (100 kHz / +45 °C) *2: ESR (100 kHz / +20 °C) *3: tan δ (120 Hz / +20 °C) *4: After 5 minutes

◆ Please refer to each page in this catalog for "Reflow conditions", "Taping specifications" and "Floor life level".

◆ Small order quantity (500 pcs/reel) is available with TPE series. Please contact our sales representative if you prefer it.

NRFND Not recommended for new design

Conductive Polymer Tantalum Solid Capacitors Surface Mount Type TPF series

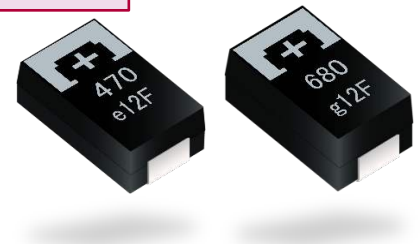

Features

- Super low ESR (5 mΩ max.)
- Large capacitance (1000 μF max.)
- RoHS compliance, Halogen free

Specifications

Size code	D2E	D3L	D4
Category temp. range	-55 °C to +105 °C		
Rated volt. range	2.0 V	2.5 V to 10 V	2.5 V to 6.3 V
Category volt. range	2.0 V	2.5 V to 10 V	2.5 V to 6.3 V
Rated cap. range	220 μF to 330 μF	150 μF to 680 μF	470 μF to 1000 μF
Capacitance tolerance	±20 % (120 Hz / +20 °C)		
Leakage current	Please see the attached characteristics list		
Dissipation factor(tan δ)	Please see the attached characteristics list		
Surge voltage (V)	Rated voltage × 1.15		
Endurance	+105 °C 2000 h rated voltage applied		
	Capacitance change	Within ±20 % of the initial value	
	Dissipation factor(tan δ)	≤ 1.5 times of the initial limit	
	Leakage current	Within the initial limit	
Damp heat (Steady State)	+60 °C, 90 % to 95 % RH, 500 h, No-applied voltage		
	Capacitance change	Within +50 %, -20 % of the initial value (2TPF220M6, 2TPF330M6, ETPF1000M6H (5H))	
		Within +40 %, -20 % of the initial value (Except for above model)	
	Dissipation factor(tan δ)	≤ 1.5 times of the initial limit	
Leakage current	≤ 3 times of the initial limit		

Marking

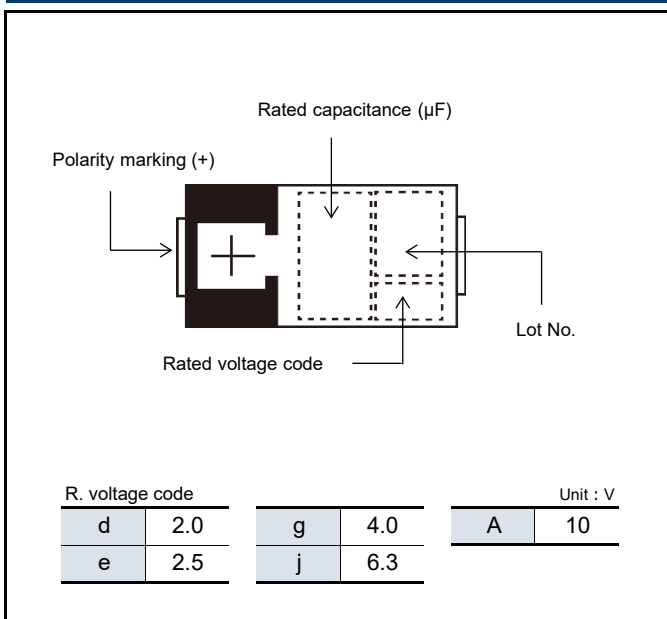

Dimensions (not to scale)

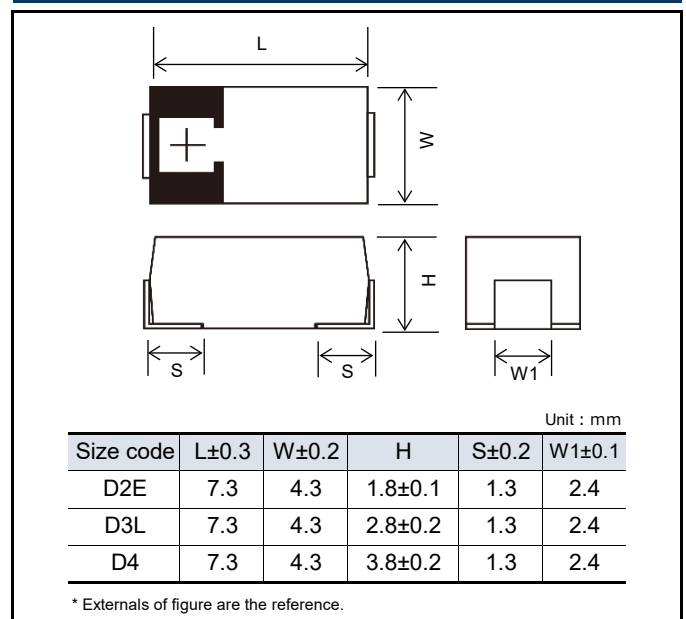

Characteristics list

Rated voltage (V)	Rated temperature (°C)	Category voltage (V)	Category temperature (°C)	Rated capacitance (µF)	Case size (mm)			Size code	Specifications				Standard		Floor life level					
					L	W	H		Ripple ^{*1} current (mA rms)	ESR ^{*2} (mΩ max.)	tan δ ^{*3}	LC ^{*4} (µA)	Part number	Min. packaging qty (pcs)	Reflow temp ≤260°C	Reflow temp ≤250°C				
2.0	105	2.0	105	220	7.3	4.3	1.8	D2E	4700	6	0.10	88.0	2TPF220M6	3000	-					
					7.3	4.3	1.8		4700	6	0.10	132.0	2TPF330M6	3000						
2.5	105	2.5	105	330	7.3	4.3	2.8	D3L	4400	7	0.10	82.5	2R5TPF330M7L	2500	3					
					7.3	4.3	2.8		4400	6	0.10	117.5	2R5TPF470M6L	2500						
					7.3	4.3	2.8		4400	7	0.10	117.5	2R5TPF470M7L	2500						
					7.3	4.3	2.8	470	7.3	4.3	2.8	D4	4400	10			0.10	117.5	2R5TPF470ML	2500
					7.3	4.3	3.8		6100	5	0.10		117.5	ETPF470M5H			2000			
					7.3	4.3	2.8		3850	9	0.10		117.5	2R5TPF470M9L			2500			
				7.3	4.3	2.8	680	D3L	7.3	4.3	2.8	4400	6	0.10			170.0	2R5TPF680M6L	2500	
				7.3	4.3	2.8			4400	7	0.10	170.0	2R5TPF680M7L	2500						
				7.3	4.3	2.8			4400	10	0.10	170.0	2R5TPF680ML	2500						
				7.3	4.3	3.8		1000	D4	6100	5	0.10	170.0	ETPF680M5H			2000			
				7.3	4.3	3.8				2700	25	0.10	170.0	ETPF680MPH			2000			
				7.3	4.3	3.8				6100	5	0.10	250.0	ETPF1000M5H			2000			
				7.3	4.3	3.8	4.0	D3L	7.3	4.3	2.8	5600	6	0.10			250.0	ETPF1000M6H	2000	
				7.3	4.3	2.8			3900	9	0.10	132.0	4TPF330M9L	2500						
4.0	105	4.0	105	330	7.3	4.3	2.8	D3L	4000	12	0.10	132.0	4TPF330ML	2500	2a					
					7.3	4.3	2.8		3550	15	0.10	132.0	4TPF330MFL	2500						
					7.3	4.3	2.8		4400	10	0.10	188.0	4TPF470ML	2500						
				7.3	4.3	3.8	680	D4	7.3	4.3	3.8	4400	10	0.10			272.0	4TPF680MAH	2000	
				7.3	4.3	3.8			3550	15	0.10	272.0	4TPF680MFH	2000						
				7.3	4.3	3.8			2350	35	0.10	272.0	4TPF680MZH	2000						
				7.3	4.3	2.8			2750	25	0.10	94.5	6TPF150MPL	2500						
6.3	105	6.3	105	220	7.3	4.3	2.8	D3L	6100	5	0.10	138.6	6TPF220M5L	2500	3					
					7.3	4.3	2.8		5550	6	0.10	138.6	6TPF220M6L	2500						
					7.3	4.3	2.8		4600	9	0.10	138.6	6TPF220M9L	2500						
					7.3	4.3	2.8		4000	12	0.10	138.6	6TPF220ML	2500						
					7.3	4.3	2.8		3550	15	0.10	138.6	6TPF220MFL	2500						
					7.3	4.3	2.8		2750	25	0.10	138.6	6TPF220MPL	2500						
				7.3	4.3	2.8	330	D4	7.3	4.3	2.8	3900	9	0.10			207.9	6TPF330M9L	2500	
				7.3	4.3	2.8			3650	10	0.10	207.9	6TPF330MAL	2500						
				7.3	4.3	3.8			4400	10	0.10	296.1	6TPF470MAH	2000						
				7.3	4.3	3.8			3550	15	0.10	296.1	6TPF470MFH	2000						
10	105	10	105	150	7.3	4.3	2.8	D3L	3600	15	0.10	150.0	10TPF150ML	2500	-					

*1: Ripple current (100 kHz / +45 °C)

*2: ESR (100 kHz / +20 °C)

*3: tan δ (120 Hz / +20 °C)

*4: After 5 minutes

◆ Please refer to each page in this catalog for "Reflow conditions", "Taping specifications" and "Floor life level".

◆ Small order quantity (500 pcs/reel) is available with TPF series. Please contact our sales representative if you prefer it.

NRFND Not recommended for new design

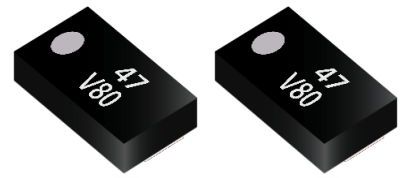

Conductive Polymer Tantalum Solid Capacitors

Surface Mount Type

TQS series

Features

- High voltage (35 V max.)
- RoHS compliance, Halogen free

Specifications

Size code	D15S	
Category temp. range	-55 °C to +105 °C	
Rated volt. range	35 V	
Category volt. range	35 V	
Rated cap. range	47 μF	
Capacitance tolerance	±20 % (120 Hz / +20 °C)	
Leakage current	Please see the attached characteristics list	
Dissipation factor(tan δ)	Please see the attached characteristics list	
Surge voltage (V)	Rated voltage × 1.15	
Endurance	+105 °C 2000 h rated voltage applied	
	Capacitance change	Within ±20 % of the initial value
	Dissipation factor(tan δ)	≤ 1.5 times of the initial limit
	Leakage current	Within the initial limit
Damp heat (Steady State)	+60 °C, 90 % to 95 % RH, 500 h, No-applied voltage	
	Capacitance change	Within +40 %, -20 % of the initial value
	Dissipation factor(tan δ)	≤ 1.5 times of the initial limit
	Leakage current	≤ 3 times of the initial limit

Marking

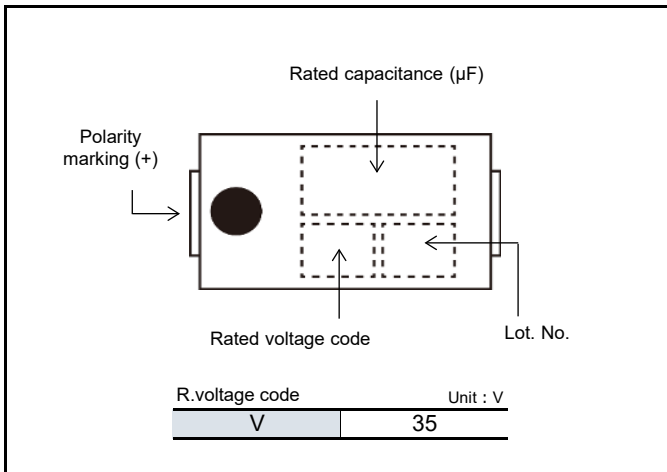

Dimensions (not to scale)

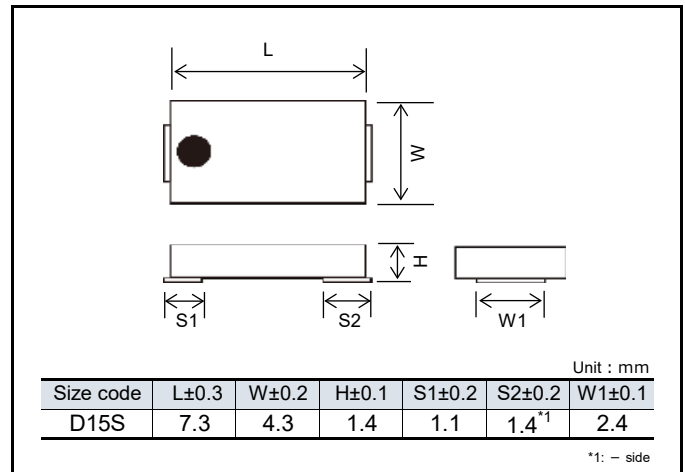

Characteristics list

Rated voltage (V)	Rated temperature (°C)	Category voltage (V)	Category temperature (°C)	Rated capacitance (μF)	Case size (mm)			Size code	Specifications				Standard		Floor life level	
					L	W	H		Ripple current ^{*1} (mA rms)	ESR ^{*2} (mΩ max.)	tan δ ^{*3}	LC ^{*4} (μA)	Part number	Min. packaging q'ty (pcs)	Reflow temp ≤260°C	Reflow temp ≤250°C
35	105	35	105	47	7.3	4.3	1.4	D15S	1200	100	0.10	164.5	35TQS47MEU	4000	3	3

*1: Ripple current (100 kHz / +105 °C)

*2: ESR (100 kHz / +20 °C)

*3: tan δ (120 Hz / +20 °C)

*4: After 5 minutes

◆ Please refer to each page in this catalog for "Reflow conditions", "Taping specifications" and "Floor life level".



Conductive Polymer Tantalum Solid Capacitors

Surface Mount Type

TQC series **B** size

Features

- High voltage (35 V max.)
- RoHS compliance, Halogen free

Specifications

Size code	B2	
Category temp. range	-55 °C to +105 °C	
Rated volt. range	16 V to 35 V	
Category volt. range	16 V to 35 V	
Rated cap. range	3.9 μF to 47 μF	
Capacitance tolerance	±20 % (120 Hz / +20 °C)	
Leakage current	Please see the attached characteristics list	
Dissipation factor(tan δ)	Please see the attached characteristics list	
Surge voltage (V)	Rated voltage × 1.15	
Endurance	+105 °C 2000 h (16TQC33MYFB : 1000 h), rated voltage applied	
	Capacitance change	Within ±20 % of the initial value
	Dissipation factor(tan δ)	≤ 1.5 times of the initial limit
	Leakage current	Within the initial limit
Damp heat (Steady State)	+60 °C, 90 % to 95 % RH, 500 h, No-applied voltage	
	Capacitance change	Within +40 %, -20 % of the initial value
	Dissipation factor(tan δ)	≤ 1.5 times of the initial limit
	Leakage current	≤ 3 times of the initial limit

Marking

Rated capacitance code

Polarity marking (+)

Rated voltage code

Lot. No.

Code	Value (V)
C	16
D	20
E	25
V	35

Code	Value (μF)
Q6	3.9
U6	5.6
Y6	8.2
A7	10
E7	15
J7	22
N7	33
S7	47

Dimensions (not to scale)

Size code	L±0.2	W±0.2	H±0.1	S±0.2	W1±0.1
B2	3.5	2.8	1.9	0.8	2.2

Unit : mm

* Externals of figure are the reference.

Characteristics list

Rated voltage (V)	Rated temperature (°C)	Category voltage (V)	Category temperature (°C)	Rated capacitance (µF)	Case size (mm)			Size code	Specifications				Standard		Floor life level		
					L	W	H		Ripple current (mA rms)	ESR ^{*2} (mΩ max.)	tan δ ^{*3}	LC ^{*4} (µA)	Part number	Min. packaging q'ty (pcs)	Reflow temp ≤260°C	Reflow temp ≤250°C	
16	105	16	105	10	3.5	2.8	1.9	B2	800	100	0.10	48.0	16TQC10M	2000	-	3	
	105	16	105	15	3.5	2.8	1.9		1000	90	0.10	72.0	16TQC15M	2000			
	105	16	105	22	3.5	2.8	1.9		1000	90	0.10	35.2	16TQC22MYFB	2000			
	105	16	105	33	3.5	2.8	1.9		1000	90	0.10	158.4	16TQC33MYFB	2000			
	105	16	105	47	3.5	2.8	1.9		1000	90	0.15	225.6	16TQC47MYFB	2000	3		
20	105	20	105	8.2	3.5	2.8	1.9		800	100	0.10	49.2	20TQC8R2M	2000	-		
	105	20	105	22	3.5	2.8	1.9		1100	90	0.10	132.0	20TQC22MYFB	2000			
25	105	25	105	5.6	3.5	2.8	1.9		800	100	0.10	42.0	25TQC5R6M	2000			
	105	25	105	10	3.5	2.8	1.9		900	100	0.10	25.0	25TQC10MEB	2000			
	105	25	105	15	3.5	2.8	1.9		900	100	0.10	112.5	25TQC15MYFB	2000			
	105	25	105	22	3.5	2.8	1.9		1100	100	0.10	165.0	25TQC22MYFB	2000			3
35	105	35	105	3.9	3.5	2.8	1.9		500	400	0.10	40.9	35TQC3R9MYF	2000			-
	105	35	105	10	3.5	2.8	1.9		900	150	0.15	105.0	35TQC10MYFB	2000			3
	105	35	105		3.5	2.8	1.9		750	200	0.15	105.5	35TQC10MXB	2000			3

*1: Ripple current (100 kHz / +105 °C)

*2: ESR (100 kHz / +20 °C)

*3: tan δ (120 Hz / +20 °C)

*4: After 5 minutes

◆ Please refer to each page in this catalog for "Reflow conditions", "Taping specifications" and "Floor life level".

◆ Small order quantity (500 pcs/reel) is available with TQC series. Please contact our sales representative if you prefer it.



Conductive Polymer Tantalum Solid Capacitors

Surface Mount Type

TQC series D size

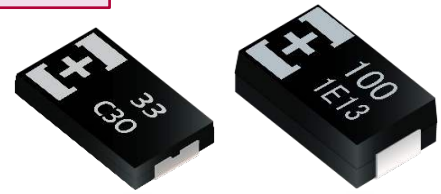

Features

- High voltage (35 V max.)
- RoHS compliance, Halogen free

Specifications

Size code	D12	D15	D2	D3L
Category temp. range	-55 °C to +105 °C			
Rated volt. range	16 V	16 V to 25 V	16 V to 35 V	16 V to 25 V
Category volt. range	16 V	16 V to 25 V	16 V to 35 V	16 V to 25 V
Rated cap. range	33 µF	22 µF to 47 µF	10 µF to 150 µF	68 µF to 220 µF
Capacitance tolerance	±20 % (120 Hz / +20 °C)			
Leakage current	Please see the attached characteristics list			
Dissipation factor(tan δ)	Please see the attached characteristics list			
Surge voltage (V)	Rated voltage × 1.15			
Endurance	+105 °C 2000 h rated voltage applied			
	Capacitance change	Within ±20 % of the initial value		
	Dissipation factor(tan δ)	≤ 1.5 times of the initial limit		
	Leakage current	Within the initial limit		
Damp heat (Steady State)	+60 °C, 90 % to 95 % RH, 500 h, No-applied voltage			
	Capacitance change	Within +40 %, -20 % of the initial value		
	Dissipation factor(tan δ)	≤ 1.5 times of the initial limit		
	Leakage current	≤ 3 times of the initial limit		

Marking

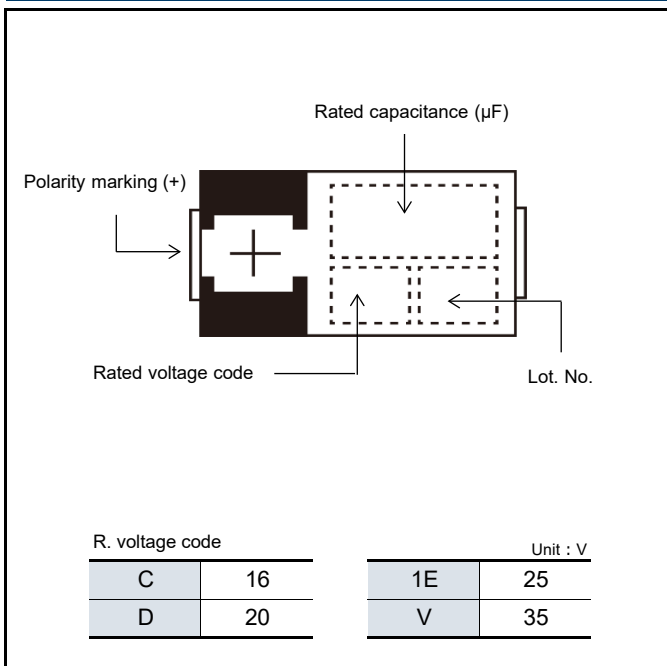

Dimensions (not to scale)

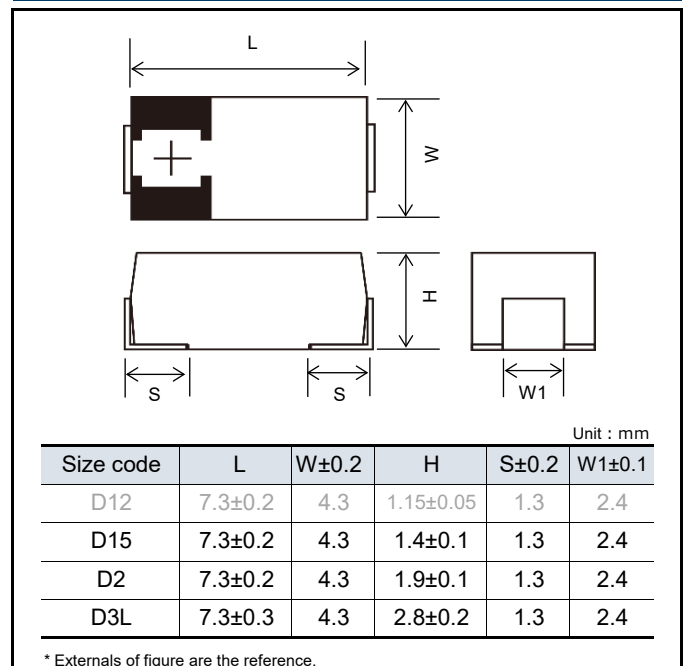

Characteristics list

Rated voltage (V)	Rated temperature (°C)	Category voltage (V)	Category temperature (°C)	Rated capacitance (µF)	Case size (mm)			Size code	Specifications				Standard		Floor life level	
					L	W	H		Ripple ^{*1} current (mA rms)	ESR ^{*2} (mΩ max.)	tan δ ^{*3}	LC ^{*4} (µA)	Part number	Min. packaging q'ty (pcs)	Reflow temp ≤260°C	Reflow temp ≤250°C
16	NRFND 105	16	105	33	7.3	4.3	1.15	D12	1800	40	0.10	52.8	16TQC33MYFS	4500	-	3
	105	16	105		7.3	4.3	1.9	D2	1400	70	0.10	52.8	16TQC33MYFD	3000		
	105	16	105	47	7.3	4.3	1.4	D15	1500	55	0.10	75.2	16TQC47MYFT	3000		
	105	16	105		7.3	4.3	1.9	D2	1800	40	0.10	75.2	16TQC47MW	3000		
	105	16	105		7.3	4.3	1.9		1450	55	0.10	75.2	16TQC47MYFD	3000		
	105	16	105		7.3	4.3	1.9		1250	70	0.10	75.2	16TQC47MBD	3000		
	105	16	105		68	7.3	4.3		1.9	1500	50	0.10	108.8	16TQC68MYF		
	105	16	105	100	7.3	4.3	1.9		1800	50	0.10	160.0	16TQC100MYF	3000		
	105	16	105	150	7.3	4.3	2.8	D3L	1800	50	0.10	240.0	16TQC150MYF	2500		
	105	16	105	150	7.3	4.3	1.9	D2	1500	70	0.15	240.0	1CTQC15173F1	3000		
	105	16	105	220	7.3	4.3	2.8	D3L	1750	50	0.10	352.0	16TQC220MD3	2500		
20	105	20	105	22	7.3	4.3	1.9	D2	1200	90	0.10	44.0	20TQC22MQD	3000		
	105	20	105	33	7.3	4.3	1.9		1400	60	0.10	66.0	20TQC33MYFD	3000		
	105	20	105	47	7.3	4.3	1.9		1450	55	0.10	94.0	20TQC47MYF	3000		
	105	20	105		7.3	4.3	1.4	D15	1500	55	0.10	94.0	20TQC47MYFT	3000		
	105	20	105	100	7.3	4.3	1.9	D2	1250	100	0.15	200.0	20TQC100MD2	3000		
	105	20	105		7.3	4.3	2.8	D3L	1700	55	0.10	200.0	20TQC100MYF	2500		
25	105	25	105	15	7.3	4.3	1.9	D2	1500	45	0.10	38.0	25TQC15MV	3000		
	105	25	105		7.3	4.3	1.9		1000	90	0.10	38.0	25TQC15MYFD	3000		
	105	25	105	22	7.3	4.3	1.9		1500	45	0.10	55.0	25TQC22MV	3000		
	105	25	105		7.3	4.3	1.9		1400	60	0.10	55.0	25TQC22MYFD	3000		
	105	25	105	33	7.3	4.3	1.4	D15	1400	70	0.10	55.0	25TQC22MYFT	3000		
	105	25	105		7.3	4.3	1.9	D2	1400	60	0.10	82.5	25TQC33MYF	3000		
	105	25	105	68	7.3	4.3	2.8	D3L	1400	70	0.10	170.0	25TQC68MYF	2500		
	105	25	105	100	7.3	4.3	2.8		1600	60	0.10	250.0	25TQC100MD3	2500		
35	NRFND 105	35	105	10	7.3	4.3	1.9	D2	1000	120	0.10	35.0	35TQC10M	3000		
	105	35	105		7.3	4.3	1.9		1000	120	0.10	35.0	35TQC10MYF	3000		
	105	35	105	15	7.3	4.3	1.9		900	150	0.10	52.5	35TQC15MYF	3000		

*1: Ripple current (100 kHz / +105 °C)

*2: ESR (100 kHz / +20 °C)

*3: tan δ (120 Hz / +20 °C)

*4: After 5 minutes

◆ Please refer to each page in this catalog for "Reflow conditions", "Taping specifications" and "Floor life level".

◆ Small order quantity (500 pcs/reel) is available with TQC series. Please contact our sales representative if you prefer it.

NRFND

Not recommended for new design

Conductive Polymer Tantalum Solid Capacitors Surface Mount Type TA series

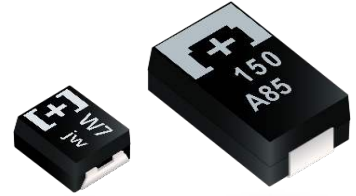

■ This product is not intended for use in any driving application or any other critical functions that affect passenger safety (e.g. Powertrain, ABS, Engine ECU, Airbag, etc.)
If the intended use of TA/TV series products is for use in other automotive related applications, please contact our sales team. All requests are subject to approval.

Features

- Guaranteed at 85 °C 85 %RH
- RoHS compliance, Halogen free

Specifications

Size code	B2	D2E	D3L
Category temp. range	-55 °C to +105 °C		
Rated volt. range	4.0 V to 10 V	2.5 V to 10 V	
Category volt. range	4.0 V to 10 V	2.5 V to 10 V	
Rated cap. range	47 μF to 100 μF	68 μF to 470 μF	150 μF to 680 μF
Capacitance tolerance	±20 % (120 Hz / +20 °C)		
Leakage current	Please see the attached characteristics list		
Dissipation factor(tan δ)	Please see the attached characteristics list		
Surge voltage (V)	Rated voltage × 1.15		
Endurance	+105 °C 2000 h (B2 size : 1000 h) , rated voltage applied		
	Capacitance change	Within ±20 % of the initial value	
	Dissipation factor(tan δ)	≤ 1.5 times of the initial limit	
	Leakage current	Within the initial limit	
Damp heat (Steady State)	+85 °C, 85 % to 90 % RH, 500 h, rated voltage applied		
	Capacitance change	Within +50 %, -20 % of the initial value (2R5TAE470M (F), 2R5TAE330M (I, F), 2R5TAE220M (F, 9))	
		Within +40 %, -20 % of the initial value (Except for above model)	
	Dissipation factor(tan δ)	≤ 1.5 times of the initial limit	
Leakage current	Within the initial limit		

Marking

< B2 size >

< D2E, D3L size >

e	2.5
g	4

j	6.3
A	10

S7	47
W7	68

A8	100
----	-----

Dimensions (not to scale)

Size code	L	W±0.2	H	S±0.2	W1±0.1
B2	3.5±0.2	2.8	1.9±0.1	0.8	2.2
D2E	7.3±0.3	4.3	1.8±0.1	1.3	2.4
D3L	7.3±0.3	4.3	2.8±0.2	1.3	2.4

* Externals of figure are the reference.

Characteristics list

Rated voltage (V)	Rated temperature (°C)	Category voltage (V)	Category temperature (°C)	Rated capacitance (μF)	Case size (mm)			Size code	Specifications				Standard		Floor life level		
					L	W	H		Ripple ^{*1} current (mA rms)	ESR ^{*2} (mΩ max.)	tan δ ^{*3}	LC ^{*4} (μA)	Part number	Min. packaging qty (pcs)	Reflow temp ≤260°C	Reflow temp ≤250°C	
2.5	105	2.5	105	220	7.3	4.3	1.8	D2E	3900	9	0.10	110.0	2R5TAE220M9	3000	3	3	
	105	2.5	105		7.3	4.3	1.8		3100	15	0.10	55.0	2R5TAE220MF	3000			
	105	2.5	105		7.3	4.3	1.8		2400	25	0.10	55.0	2R5TAE220M	3000			
	105	2.5	105	330	7.3	4.3	1.8		3100	15	0.10	82.5	2R5TAE330MF	3000			
	105	2.5	105		7.3	4.3	1.8		2800	18	0.10	82.5	2R5TAE330MI	3000			
	105	2.5	105		7.3	4.3	1.8		2400	25	0.10	82.5	2R5TAE330M	3000			
	105	2.5	105	470	7.3	4.3	1.8		3100	15	0.10	117.5	2R5TAE470MF	3000			
	105	2.5	105		7.3	4.3	1.8		2400	25	0.10	117.5	2R5TAE470M	3000			
	105	2.5	105	680	7.3	4.3	2.8		D3L	3100	15	0.10	170.0	2R5TAE680MFL			2500
	105	2.5	105		7.3	4.3	2.8		D3L	2400	25	0.10	170.0	2R5TAE680ML			2500
4.0	105	4.0	105	100	3.8	2.8	1.9	B2	1100	70	0.08	40.0	4TAB100M	2000	3	3	
	105	4.0	105	220	7.3	4.3	1.8	D2E	2800	18	0.10	88.0	4TAE220MI	3000			
	105	4.0	105		7.3	4.3	1.8		2400	25	0.10	88.0	4TAE220M	3000			
	105	4.0	105	470	7.3	4.3	2.8	D3L	2800	18	0.10	188.0	4TAE470MIL	2500			
	105	4.0	105		7.3	4.3	2.8		2400	25	0.10	188.0	4TAE470ML	2500			
6.3	105	6.3	105	47	3.5	2.8	1.9	B2	1100	70	0.08	29.6	6TAB47M	2000	3	3	
	105	6.3	105	68	3.5	2.8	1.9		1100	70	0.08	42.8	6TAB68M	2000			
	105	6.3	105	150	7.3	4.3	1.8	D2E	2400	25	0.10	94.5	6TAE150M	3000			
	105	6.3	105	220	7.3	4.3	1.8		2800	18	0.10	138.6	6TAE220MI	3000			
	105	6.3	105		7.3	4.3	1.8		2400	25	0.10	138.6	6TAE220M	3000			
	105	6.3	105	330	7.3	4.3	2.8		D3L	2400	25	0.10	207.9	6TAE330ML			2500
10	105	10	105	47	3.5	2.8	1.9	B2	1100	70	0.08	47.0	10TAB47M	2000	3	3	
	105	10	105	68	7.3	4.3	1.8	D2E	2400	25	0.10	68.0	10TAE68M	3000			
	105	10	105	150	7.3	4.3	2.8	D3L	2400	25	0.10	150.0	10TAE150ML	2500			
	105	10	105	220	7.3	4.3	2.8		2400	25	0.10	220.0	10TAE220ML	2500			

*1: Ripple current (100 kHz / +45 °C)

*2: ESR (100 kHz / +20 °C)

*3: tan δ (120 Hz / +20 °C)

*4: After 5 minutes

◆ Please refer to each page in this catalog for "Reflow conditions", "Taping specifications" and "Floor life level".

Conductive Polymer Tantalum Solid Capacitors Surface Mount Type TV series

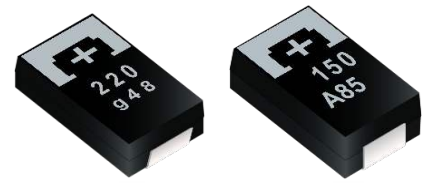

■ This product is not intended for use in any driving application or any other critical functions that affect passenger safety (e.g. Powertrain, ABS, Engine ECU, Airbag, etc.)
If the intended use of TA/TV series products is for use in other automotive related applications, please contact our sales team. All requests are subject to approval.

Features

- Guaranteed at 85 °C 85 %RH
- Guaranteed at 125 °C
- RoHS compliance, Halogen free

Specifications

Size code	D2E		D3L
Category temp. range	-55 °C to +125 °C		
Rated volt. range	6.3 V to 10 V		10 V
Category volt. range	4.0 V to 6.3 V		6.3 V
Rated cap. range	68 µF to 150 µF		150 µF
Capacitance tolerance	±20 % (120 Hz / +20 °C)		
Leakage current	Please see the attached characteristics list		
Dissipation factor(tan δ)	Please see the attached characteristics list		
Surge voltage (V)	Rated voltage × 1.15		
Endurance	+125 °C 1000 h, category voltage applied (+105 °C 2000 h, rated voltage applied)		
	Temperature	125 °C	105 °C
	Capacitance change	Within ±20% of the initial value	Within ±20% of the initial value
	Dissipation factor(tan δ)	≤ 2 times of the initial limit	≤ 1.5 times of the initial limit
	Leakage current	≤ 2 times of the initial limit	Within the initial limit
Damp heat (Steady State)	+85 °C, 85 % to 90 % RH, 500 h, rated voltage applied		
	Capacitance change	Within +40 %, -20 % of the initial value	
	Dissipation factor(tan δ)	≤ 1.5 times of the initial limit	
	Leakage current	Within the initial limit	

Marking

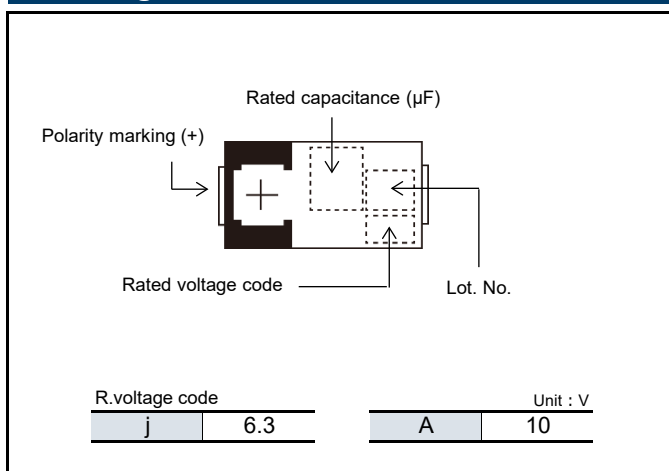

Dimensions (not to scale)

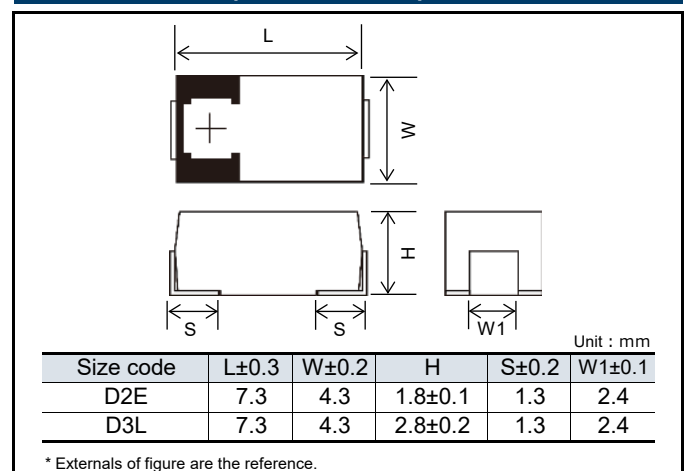

Characteristics list

Rated voltage (V)	Rated temperature (°C)	Category voltage (V)	Category temperature (°C)	Rated capacitance (µF)	Case size (mm)			Size code	Specifications				Standard		Floor life level						
					L	W	H		Ripple current ^{*1} (mA rms)	ESR ^{*2} (mΩ max.)	tan δ ^{*3}	LC ^{*4} (µA)	Part number	Min. packaging q'ty (pcs)	Reflow temp ≤200°C	Reflow temp ≤250°C					
6.3	105	4.0	125	150	7.3	4.3	1.8	D2E	2400	25	0.10	94.5	6TVE150M	3000	5	3					
																	7.3	4.3	1.8	2400	25
					7.3	4.3	2.8														

*1: Ripple current (100 kHz / +45 °C) *2: ESR (100 kHz / +20 °C) *3: tan δ (120 Hz / +20 °C) *4: After 5 minutes

◆ Please refer to each page in this catalog for "Reflow conditions", "Taping specifications" and "Floor life level".

Conductive Polymer Tantalum
Solid Capacitors
Surface Mount Type
TH series

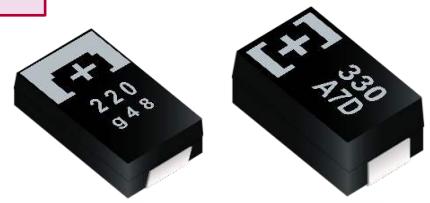

Features

- Guaranteed at 125 °C 1000 h
- RoHS compliance, Halogen free

Specifications

Size code	D2E	D2	D3L	D4
Category temp. range	-55 °C to +125 °C			
Rated volt. range	2.5 V to 6.3 V	2.5 V to 10 V	4.0 V to 6.3 V	6.3 V to 10 V
Category volt. range	1.6 V to 4.0 V	1.6 V to 6.3 V	2.5 V to 4.0 V	4.0 V to 6.3 V
Rated cap. range	150 µF to 330 µF	68 µF to 220 µF	220 µF to 330 µF	220 µF to 470 µF
Capacitance tolerance	±20 % (120 Hz / +20 °C)			
Leakage current	Please see the attached characteristics list			
Dissipation factor(tan δ)	Please see the attached characteristics list			
Surge voltage (V)	Rated voltage × 1.15			
Endurance	+125 °C 1000 h, category voltage applied			
	Capacitance change	Within ±20 % of the initial value		
	Dissipation factor(tan δ)	≤ 2 times of the initial limit		
	Leakage current	≤ 2 times of the initial limit		
Damp heat (Steady State)	+60 °C, 90 % to 95 % RH, 500 h, No-applied voltage			
	Capacitance change	Within +40 %, -20 % of the initial value		
	Dissipation factor(tan δ)	≤ 1.5 times of the initial limit		
	Leakage current	≤ 3 times of the initial limit		

Marking

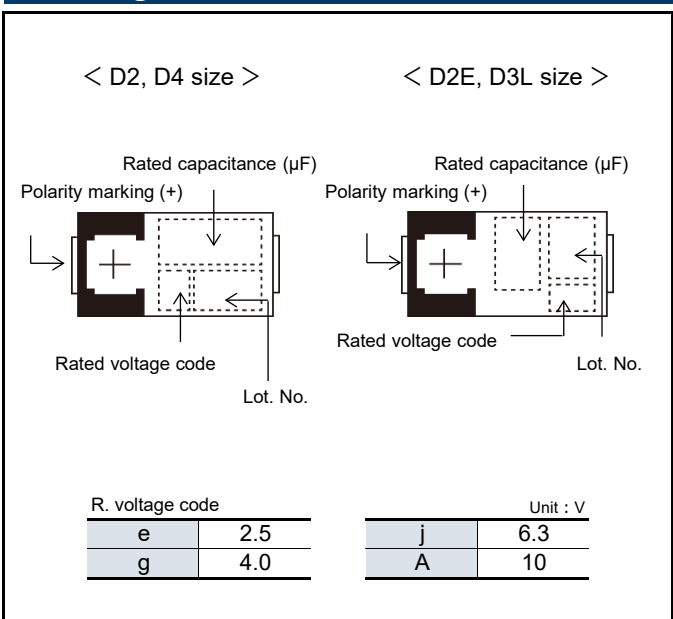

Dimensions (not to scale)

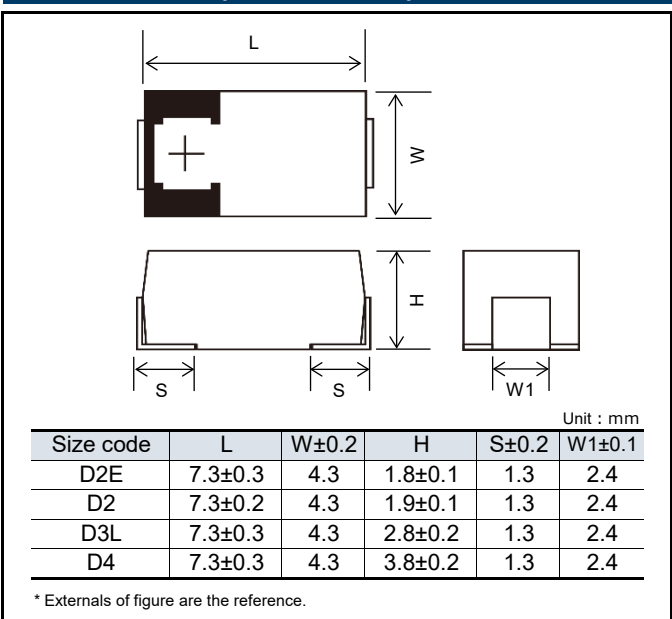

Characteristics list

Series	Rated voltage (V)	Rated temperature (°C)	Category voltage (V)	Category temp. (°C)	Rated capacitance (μF)	Case size (mm)			Size code	Specifications				Standard		Floor life level	
						L	W	H		Ripple ^{*1} current (mA rms)	ESR ^{*2} (mΩ max.)	tan δ ^{*3}	LC ^{*4} (μA)	Part number	Min. packaging q'ty (pcs)	Reflow temp ≤260°C	Reflow temp ≤250°C
THB	4.0	105	2.5	125	330	7.3	4.3	2.8	D3L	2000	40	0.10	132.0	4THB330ML	2500	-	5
	6.3	105	4.0	125	220	7.3	4.3	2.8		2000	40	0.10	138.6	6THB220ML	2500		
		105	4.0	125	330	7.3	4.3	3.8	D4	3000	40	0.10	207.9	6THB330M	2000		
	10	105	4.0	125	470	7.3	4.3	3.8		3000	35	0.10	296.1	6THB470M	2000		
		105	6.3	125	220	7.3	4.3	3.8		3000	40	0.10	220.0	10THB220M	2000		
	105	6.3	125	330	7.3	4.3	3.8	3000		35	0.10	330.0	10THB330M	2000			
THC	2.5	105	1.6	125	220	7.3	4.3	1.9	D2	1700	45	0.10	55.0	2R5THC220M	3000		
	6.3	105	4.0	125	150	7.3	4.3	1.9		1900	40	0.10	94.5	6THC150M	3000		
	10	105	6.3	125	68	7.3	4.3	1.9		1700	45	0.10	68.0	10THC68M	3000		
THE	2.5	105	1.6	125	330	7.3	4.3	1.8	D2E	3100	15	0.10	82.5	2R5THE330MF	3000		
		105	1.6	125		7.3	4.3	1.8		2800	18	0.10	82.5	2R5THE330MI	3000		
		105	1.6	125		7.3	4.3	1.8		2400	25	0.10	82.5	2R5THE330M	3000		
	4.0	105	2.5	125	220	7.3	4.3	1.8		3100	15	0.10	88.0	4THE220MF	3000		
		105	2.5	125		7.3	4.3	1.8		2800	18	0.10	88.0	4THE220MI	3000		
		105	2.5	125		7.3	4.3	1.8		2400	25	0.10	88.0	4THE220M	3000		
	6.3	105	4.0	125	150	7.3	4.3	1.8		2800	18	0.10	94.5	6THE150MI	3000		
		105	4.0	125		7.3	4.3	1.8		2400	25	0.10	94.5	6THE150M	3000		

*1: Ripple current (100 kHz / +45 °C)

*2: ESR (100 kHz / +20 °C)

*3: tan δ (120 Hz / +20 °C)

*4: After 5 minutes

◆ Please refer to each page in this catalog for "Reflow conditions", "Taping specifications" and "Floor life level".

Conductive Polymer Tantalum Solid Capacitors

Surface Mount Type

TPB series

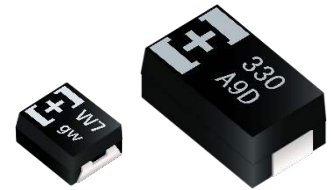

Features

- Standard
- RoHS compliance, Halogen free

Specifications

Size code	B2	D3L	D4
Category temp. range	-55 °C to +105 °C		
Rated volt. range	4.0 V to 10 V		6.3 V to 10 V
Category volt. range	4.0 V to 10 V		6.3 V to 10 V
Rated cap. range	33 µF to 68 µF	150 µF to 330 µF	220 µF to 470 µF
Capacitance tolerance	±20 % (120 Hz / +20 °C)		
Leakage current	Please see the attached characteristics list		
Dissipation factor(tan δ)	Please see the attached characteristics list		
Surge voltage (V)	Rated voltage × 1.15		
Endurance	+105 °C 2000 h, (B2 size : 1000 h) rated voltage applied		
	Rated temp. +85 °C 1000 h rated voltage applied		
	Capacitance change	Within ±20 % of the initial value	
	Dissipation factor(tan δ)	≤ 1.5 times of the initial limit	
Damp heat (Steady State)	+60 °C, 90 % to 95 % RH, 500 h, No-applied voltage		
	Capacitance change	Within +40 %, -20 % of the initial value (Except for above model)	
	Dissipation factor(tan δ)	≤ 1.5 times of the initial limit	
	Leakage current	≤ 3 times of the initial limit	

Marking

< B2 size >

Rated capacitance code

< D3L size >

Rated capacitance (µF)

< D4 size >

Rated capacitance (µF)

R. voltage code		Unit : V	
g	4.0	j	6.3
A	10		

< B2 size >		Unit : µF	
N7	33	S7	47
W7	68		

Dimensions (not to scale)

Size code	L	W±0.2	H	S±0.2	W1±0.1
B2	3.5±0.2	2.8	1.9±0.1	0.8	2.2
D3L	7.3±0.3	4.3	2.8±0.2	1.3	2.4
D4	7.3±0.3	4.3	3.8±0.2	1.3	2.4

* Externals of figure are the reference.

Characteristics list

Rated voltage (V)	Rated temperature (°C)	Category voltage (V)	Category temperature (°C)	Rated capacitance (µF)	Case size (mm)			Size code	Specifications				Standard		Floor life level	
					L	W	H		Ripple current (mA rms) ^{*1}	ESR (mΩ max.) ^{*2}	tan δ ^{*3}	LC (µA) ^{*4}	Part number	Min. packaging qty (pcs)	Reflow temp ≤260°C	Reflow temp ≤250°C
4.0	105	4.0	105	68	3.5	2.8	1.9	B2	1100	70	0.08	27.2	4TPB68M	2000		3
	105	4.0	105	330	7.3	4.3	2.8	D3L	2000	40	0.10	132	4TPB330ML	2500		2a
6.3	105	6.3	105	33	3.5	2.8	1.9	B2	1100	70	0.08	20.7	6TPB33M	2000	3	3
	105	6.3	105	68	3.5	2.8	1.9		1100	70	0.08	42.8	6TPB68M	2000		
	105	6.3	105	220	7.3	4.3	2.8	D3L	2000	40	0.10	138.6	6TPB220ML	2500		2a
	105	6.3	105		7.3	4.3	2.8		1750	50	0.10	138.6	6TPB220MTL	2500		
	85	5.0	105	330	7.3	4.3	2.8	D3L	2000	40	0.10	207.9	6TPB330MAL	2500		2a
	105	6.3	105		7.3	4.3	2.8		2000	40	0.10	207.9	6TPB330ML	2500		
	105	6.3	105		7.3	4.3	3.8	D4	3000	40	0.10	207.9	6TPB330M	2000		
	105	6.3	105	470	7.3	4.3	2.8	D3L	1850	45	0.10	207.9	6TPB330MVL	2500		
	105	6.3	105		7.3	4.3	3.8	D4	3000	35	0.15	296.1	6TPB470M	2000		
10	105	10	105	33	3.5	2.8	1.9	B2	1100	70	0.08	33.0	10TPB33M	2000		3
	105	10	105	47	3.5	2.8	1.9		1100	70	0.08	47.0	10TPB47M	2000		
	105	10	105	150	7.3	4.3	2.8	D3L	2000	40	0.10	150.0	10TPB150ML	2500		
	105	10	105		7.3	4.3	2.8		1700	55	0.10	150.0	10TPB150MGL	2500		
	105	10	105	220	7.3	4.3	2.8	D3L	2000	40	0.10	220.0	10TPB220ML	2500	-	2a
	105	10	105		7.3	4.3	3.8		3000	40	0.10	220.0	10TPB220M	2000	3	
	105	10	105	330	7.3	4.3	3.8	D4	3000	35	0.10	330.0	10TPB330M	2000		
	105	10	105		7.3	4.3	3.8		2800	40	0.10	330.0	10TPB330MW	2000		-

*1: Ripple current (100 kHz / +45 °C)

*2: ESR (100 kHz / +20 °C)

*3: tan δ (120 Hz / +20 °C)

*4: After 5 minutes

◆ Please refer to each page in this catalog for "Reflow conditions", "Taping specifications" and "Floor life level".

**Conductive Polymer Tantalum
Solid Capacitors**
Surface Mount Type
TC series



Features

- Guaranteed at 125 °C 1000 h
- RoHS compliance, Halogen free

Specifications

Size code	B2	D2E	D3L	D4
Category temp. range	-55 °C to +125 °C			
Rated volt. range	2.5 V	4.0 V to 6.3 V	2.5 V to 10 V	
Category volt. range	2.0 V	3.2 V to 5.0 V	2.0 V to 8.0 V	
Rated cap. range	330 μF	100 μF to 330 μF	150 μF to 680 μF	330 μF to 1000 μF
Capacitance tolerance	±20 % (120 Hz / +20 °C)			
Leakage current	Please see the attached characteristics list			
Dissipation factor(tan δ)	Please see the attached characteristics list			
Surge voltage (V)	Rated voltage × 1.15			
Endurance	+125 °C 1000 h, category voltage applied			
	Capacitance change	Within ±20 % of the initial value		
	Dissipation factor(tan δ)	≤ 2 times of the initial limit		
	Leakage current	≤ 2 times of the initial limit		
Damp heat (Steady State)	+60 °C, 90 % to 95 % RH, 500 h, No-applied voltage			
	Capacitance change	Within +50 %, -20 % of the initial value (ETCF1000M6H(5H))		
		Within +40 %, -20 % of the initial value		
	Dissipation factor(tan δ)	≤ 1.5 times of the initial limit		
Leakage current	≤ 3 times of the initial limit			

Marking

< B2 size >

< D2E, D3L, D4 size >

R. voltage code	
e	2.5
g	4.0

Unit : V	
j	6.3
A	10

< B2 size >

R.capacitance code	Unit : μF
N8	330

Dimensions (not to scale)

Size code	L	W±0.2	H	S±0.2	W1±0.1
B2	3.5±0.2	2.8	1.9±0.1	0.8	2.2
D2E	7.3±0.3	4.3	1.8±0.1	1.3	2.4
D3L	7.3±0.3	4.3	2.8±0.2	1.3	2.4
D4	7.3±0.3	4.3	3.8±0.2	1.3	2.4

* Externals of figure are the reference.

Characteristics list

Series	Rated voltage (V)	Rated temperature (°C)	Category voltage (V)	Category temp. (°C)	Rated capacitance (μF)	Case size (mm)			Size code	Specifications				Standard		Floor life level		
						L	W	H		Ripple current ^{*1} (mA rms)	ESR ^{*2} (mΩ max.)	tan δ ^{*3}	LC ^{*4} (μA)	Part number	Min. packaging q'ty (pcs)	Reflow temp ≤260°C	Reflow temp ≤250°C	
TCE	2.5	105	2.0	125	330	3.5	2.8	1.9	B2	3200	9/300kHz	0.08	165.0	ETCE330M9GB	2000	3	2a	
		105	2.0	125	680	7.3	4.3	2.8	D3L	3500	12	0.10	170.0	ETCE680MCL	2500			
		105	2.0	125		7.3	4.3	2.8		3100	15	0.10	170.0	ETCE680MFL	2500			
		105	2.0	125	1000	7.3	4.3	3.8	D4	3900	15	0.15	250.0	ETCE1000MF	2000			
	4.0	105	3.2	125	150	7.3	4.3	1.8	D2E	2800	18	0.10	60.0	4TCE150MI	3000			
		105	3.2	125	220	7.3	4.3	1.8		3100	15	0.10	88.0	4TCE220MF	3000			
		105	3.2	125		7.3	4.3	1.8		2800	18	0.10	88.0	4TCE220MI	3000			
		105	3.2	125	330	7.3	4.3	1.8		2400	25	0.10	88.0	4TCE220M	3000			
		105	3.2	125		7.3	4.3	1.8		2800	18	0.10	132.0	4TCE330MI	3000			
		105	3.2	125		7.3	4.3	1.8		2400	25	0.10	132.0	4TCE330M	3000			
		105	3.2	125		470	7.3	4.3	2.8	3500	12	0.10	188.0	4TCE470MCL	2500			
		105	3.2	125	7.3		4.3	2.8	3100	15	0.10	188.0	4TCE470MFL	2500				
		105	3.2	125	7.3		4.3	2.8	2800	18	0.10	188.0	4TCE470MIL	2500				
		105	3.2	125	7.3		4.3	2.8	2400	25	0.10	188.0	4TCE470ML	2500				
		6.3	105	5.0	125	100	7.3	4.3	1.8	D2E	2800	18	0.10	63.0	6TCE100MI			3000
			105	5.0	125		7.3	4.3	1.8		2400	25	0.10	63.0	6TCE100M			3000
	105		5.0	125	150	7.3	4.3	1.8	3100		15	0.10	94.5	6TCE150MF	3000			
	105		5.0	125		7.3	4.3	1.8	2800		18	0.10	94.5	6TCE150MI	3000			
	105		5.0	125	220	7.3	4.3	1.8	2400	25	0.15	94.5	6TCE150M	3000				
	105		5.0	125		7.3	4.3	1.8	2800	18	0.15	138.6	6TCE220MI	3000				
	105		5.0	125		7.3	4.3	1.8	2400	25	0.15	138.6	6TCE220M	3000				
	105		5.0	125		330	7.3	4.3	2.8	3100	15	0.10	207.9	6TCE330MFL	2500			
	105		5.0	125	7.3		4.3	2.8	2800	18	0.10	207.9	6TCE330MIL	2500				
	105		5.0	125	7.3		4.3	2.8	2400	25	0.10	207.9	6TCE330ML	2500				
	105		5.0	125	470		7.3	4.3	3.8	3500	18	0.15	296.1	6TCE470MI	2000			
	105		5.0	125		7.3	4.3	3.8	3000	25	0.15	296.1	6TCE470M	2000				
	105		5.0	125		680	7.3	4.3	3.8	3500	18	0.15	428.4	6TCE680MI	2000			
	105		5.0	125			7.3	4.3	3.8	3000	25	0.15	428.4	6TCE680M	2000			
	10	105	8.0	125	220	7.3	4.3	2.8	D3L	2800	18	0.10	220.0	10TCE220MIL	2500			
		105	8.0	125		7.3	4.3	2.8		2400	25	0.10	220.0	10TCE220ML	2500			
105		8.0	125	330	7.3	4.3	3.8	D4	3000	25	0.10	330.0	10TCE330M	2000				
TCF	2.5	105	2.0	125	680	7.3	4.3	2.8	D3L	4400	6	0.10	170.0	ETCF680M6L	2500			
		105	2.0	125		7.3	4.3	2.8		4400	7	0.10	170.0	ETCF680M7L	2500			
		105	2.0	125		7.3	4.3	2.8		4400	10	0.10	170.0	ETCF680ML	2500			
		105	2.0	125	1000	7.3	4.3	3.8	D4	6100	5	0.10	170.0	ETCF680M5H	2000			
		105	2.0	125		7.3	4.3	3.8		6100	5	0.10	250.0	ETCF1000M5H	2000			
		105	2.0	125		7.3	4.3	3.8		5600	6	0.10	250.0	ETCF1000M6H	2000			
	4.0	105	3.2	125	330	7.3	4.3	2.8	D3L	4000	12	0.10	132.0	4TCF330ML	2500			
		105	3.2	125	470	7.3	4.3	2.8		4400	10	0.10	188.0	4TCF470ML	2500			
		105	3.2	125	680	7.3	4.3	3.8		D4	4400	10	0.10	272.0	4TCF680MAH	2000		
	6.3	105	5.0	125	220	7.3	4.3	2.8	D3L	6100	5	0.10	138.6	6TCF220M5L	2500			
		105	5.0	125		7.3	4.3	2.8		4600	9	0.10	138.6	6TCF220M9L	2500			
		105	5.0	125		7.3	4.3	2.8		4000	12	0.10	138.6	6TCF220ML	2500			
		105	5.0	125	330	7.3	4.3	2.8	3900	9	0.10	207.9	6TCF330M9L	2500				
		105	5.0	125	470	7.3	4.3	3.8	D4	4400	10	0.10	296.1	6TCF470MAH	2000			
10	105	8.0	125	150	7.3	4.3	2.8	D3L	3600	15	0.10	150.0	10TCF150ML	2500				

*1: Ripple current (100 kHz / +45 °C)

*2: ESR (100 kHz / +20 °C)

*3: tan δ (120 Hz / +20 °C)

*4: After 5 minutes

◆ Please refer to each page in this catalog for "Reflow conditions", "Taping specifications" and "Floor life level".

Conductive Polymer Tantalum Solid Capacitors

Surface Mount Type

TDC series

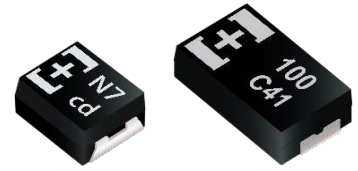

Features

- Guaranteed at 125 °C 1000 h
- High voltage (25 V max.)
- RoHS compliance, Halogen free

Specifications

Size code	B2	D2	D3L
Category temp. range	-55 °C to +125 °C		
Rated volt. range	16 V to 25 V	16 V	16 V to 25 V
Category volt. range	12.8 V to 20 V	12.8 V	12.8 V to 20 V
Rated cap. range	15 µF to 33 µF	100 µF	68 µF to 220 µF
Capacitance tolerance	±20 % (120 Hz / +20 °C)		
Leakage current	Please see the attached characteristics list		
Dissipation factor(tan δ)	Please see the attached characteristics list		
Surge voltage (V)	Rated voltage × 1.15		
Endurance	+125 °C 1000 h, category voltage applied		
	Capacitance change	Within ±20 % of the initial value	
	Dissipation factor(tan δ)	≤ 2 times of the initial limit	
	Leakage current	≤ 2 times of the initial limit	
Damp heat (Steady State)	+60 °C, 90 % to 95 % RH, 500 h, No-applied voltage		
	Capacitance change	Within +40 %, -20 % of the initial value	
	Dissipation factor(tan δ)	≤ 1.5 times of the initial limit	
	Leakage current	≤ 3 times of the initial limit	

Marking

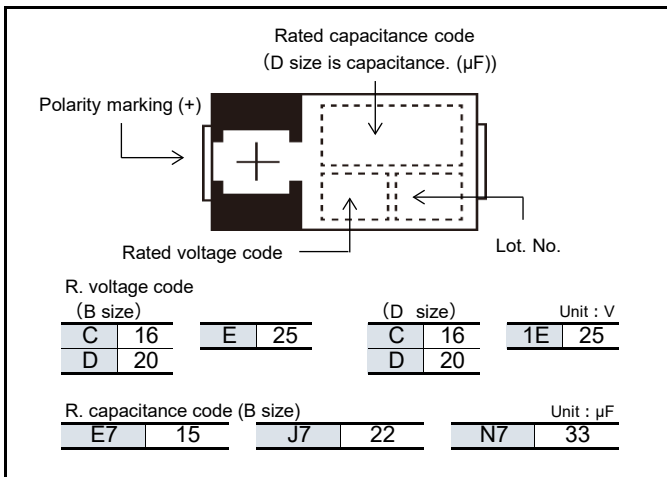

Dimensions (not to scale)

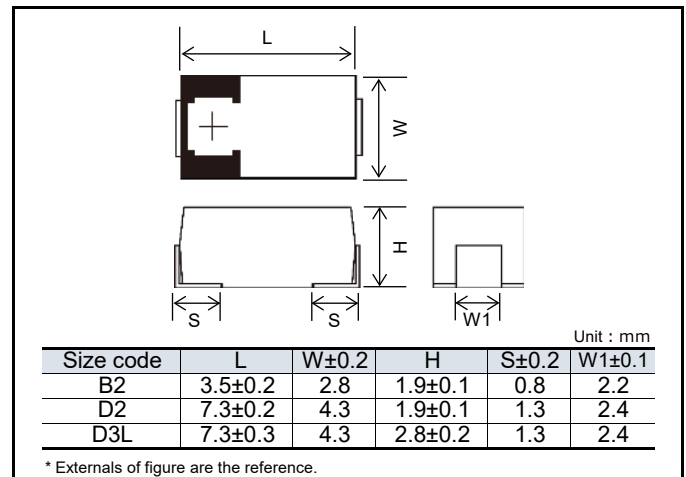

Characteristics list

Rated voltage (V)	Rated temperature (°C)	Category voltage (V)	Category temperature (°C)	Rated capacitance (µF)	Case size (mm)			Size code	Specifications				Standard		Floor life level	
					L	W	H		Ripple current ^{*1} (mA rms)	ESR ^{*2} (mΩ max.)	tan δ ^{*3}	LC ^{*4} (µA)	Part number	Min. packaging q'ty (pcs)	Reflow temp ≤260°C	Reflow temp ≤250°C
16	105	12.8	125	33	3.5	2.8	1.9	B2	1000	90	0.10	158.4	16TDC33MYFB	2000	-	3
	105	12.8	125	100	7.3	4.3	1.9	D2	1800	50	0.10	160.0	16TDC100MYF	3000		
	105	12.8	125	150	7.3	4.3	2.8	D3L	1800	50	0.10	240.0	16TDC150MYF	2500		
	105	12.8	125	220	7.3	4.3	2.8	D3L	1800	50	0.10	240.0	16TDC220MD3	2500		
20	105	16	125	22	3.5	2.8	1.9	B2	1000	90	0.10	132.0	20TDC22MYFB	2000		
	105	16	125	100	7.3	4.3	2.8	D3L	1700	55	0.10	200.0	20TDC100MYF	2500		
25	105	20	125	15	3.5	2.8	1.9	B2	900	100	0.10	112.5	25TDC15MYFB	2000		
	105	20	125	68	7.3	4.3	2.8	D3L	1400	70	0.10	170.0	25TDC68MYF	2500		
	105	20	125	100	7.3	4.3	2.8	D3L	1600	60	0.10	250.0	25TDC100MD3	2500		

*1: Ripple current (100 kHz / +105 °C) *2: ESR (100 kHz / +20 °C) *3: tan δ (120 Hz / +20 °C) *4: After 5 minutes

◆ Please refer to each page in this catalog for "Reflow conditions", "Taping specifications" and "Floor life level".



Some part numbers are not a recommended product.
Not recommended for new design.

Conductive Polymer Tantalum Solid Capacitors

Surface Mount Type

TPC series

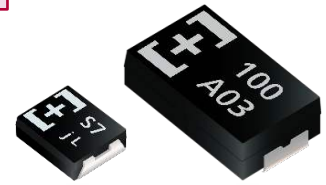

Features

- Low profile (Height 1.1 mm max.)
- RoHS compliance, Halogen free

Specifications

Size code	B1	D2
Category temp. range	-55 °C to +105 °C	
Rated volt. range	6.3 V to 12.5 V	6.3 V to 10 V
Category volt. range	5.0 V to 10 V	6.3 V to 10 V
Rated cap. range	10 μF to 47 μF	68 μF to 330 μF
Capacitance tolerance	±20 % (120 Hz / +20 °C)	
Leakage current	Please see the attached characteristics list	
Dissipation factor(tan δ)	Please see the attached characteristics list	
Surge voltage (V)	Rated voltage × 1.15	
Endurance	+105 °C 2000 h (B1 size : 1000 h) , rated voltage applied	
	Rated temp. +85 °C 1000 h rated voltage applied	
	Capacitance change	Within ±20 % of the initial value
	Dissipation factor(tan δ)	≤ 1.5 times of the initial limit
Damp heat (Steady State)	+60 °C, 90 % to 95 % RH, 500 h, No-applied voltage	
	Capacitance change	Within +40 %, -20 % of the initial value
	Dissipation factor(tan δ)	≤ 1.5 times of the initial limit
	Leakage current	≤ 3 times of the initial limit

Marking

< B1 size >

Rated capacitance code

Polarity marking (+)

Rated voltage code Lot No.

R. voltage code	
j	6.3
k	8.0

< D2 size >

Rated capacitance (μF)

Polarity marking (+)

Rated voltage code Lot No.

Unit : V	
A	10
B	12.5

< B1 size >

R. capacitance code

A7	10
E7	15

J7	22
N7	33

Unit : μF	
S7	47

Dimensions (not to scale)

Unit : mm					
Size code	L±0.2	W±0.2	H±0.1	S±0.2	W1±0.1
B1	3.5	2.8	1.1	0.8	2.2
D2	7.3	4.3	1.9	1.3	2.4

* Externals of figure are the reference.

Characteristics list

Rated voltage (V)	Rated temperature (°C)	Category voltage (V)	Category temperature (°C)	Rated capacitance (µF)	Case size (mm)			Size code	Specifications				Standard		Floor life level		
					L	W	H		Ripple current (mA rms)	ESR* ² (mΩ max.)	tan δ* ³	LC* ⁴ (µA)	Part number	Min. packaging q'ty (pcs)	Reflow temp ≤260°C	Reflow temp ≤250°C	
6.3	85	5.0	105	47	3.5	2.8	1.1	B1	1100	55	0.10	29.6	6TPC47M	3000	3		
	85	5.0	105		3.5	2.8	1.1		1000	70	0.10	29.6	6TPC47MB	3000			
	105	6.3	105	100	7.3	4.3	1.9	D2	1700	45	0.10	63.0	6TPC100M	3000			2a
	105	6.3	105	150	7.3	4.3	1.9		1900	40	0.10	94.5	6TPC150M	3000			
	85	5.0	105	330	7.3	4.3	1.9		1900	40	0.10	207.9	6TPC330MA	3000			
8.0	85	6.3	105	22	3.5	2.8	1.1	B1	1000	70	0.10	17.6	8TPC22M	3000	3		
	105	8.0	105	150	7.3	4.3	1.9	D2	1900	40	0.10	120.0	8TPC150M	3000	3		
10	105	10	105	68	7.3	4.3	1.9		1700	45	0.10	68.0	10TPC68M	3000		2a	
	105	10	105		7.3	4.3	1.9		1450	60	0.10	68.0	10TPC68MM	3000			
	105	10	105		7.3	4.3	1.9		1100	100	0.10	68.0	10TPC68ME	3000			
	105	10	105	100	7.3	4.3	1.9		1700	45	0.10	100.0	10TPC100M	3000			
	105	10	105		7.3	4.3	1.9		1600	50	0.10	100.0	10TPC100MT	3000			
	105	10	105		7.3	4.3	1.9		1500	55	0.10	100.0	10TPC100MG	3000			
12.5	85	10	105	10	3.5	2.8	1.1	B1	800	80	0.10	12.5	12TPC10M	3000	3		
	85	10	105	15	3.5	2.8	1.1		800	80	0.10	18.8	12TPC15M	3000			

*1: Ripple current (100 kHz / +45 °C)

*2: ESR (100 kHz / +20 °C)

*3: tan δ (120 Hz / +20 °C)

*4: After 5 minutes

◆ Please refer to each page in this catalog for "Reflow conditions", "Taping specifications" and "Floor life level" .

NRFND

Not recommended for new design

Catalog Deletion Models

The following table is a list of our items which have been deleted from our catalogs.

If you are using any of the following models on the deleted list,

please substitute them with the suggested alternative model as soon as possible.

Our company continue to supply them to customers who have already used them, for the time being.

Series	Size code	Models for deletion	Year of deletion	Alternative model	Series	Size code	Models for deletion	Year of deletion	Alternative model
TPB	B2	2R5TPB100M	2012	4TPE100MZB	TQC	C	16TQC22M	2011	25TQC22MYFD
		2R5TPB220MA	2009	2R5TPE220MZB			20TQC15M	2011	25TQC15MYFD
		4TPB100M	2009	4TPE100MZB			25TQC10M	2011	25TQC15MYFD
		8TPB47M	2009	10TPB47M		D12	16TQC33MYFS	2022	16TQC33MYFD
		6TPB47M	2009	6TPC47MB			16TQC33M	2012	16TQC33MYFD
		6TPB100MA	2009	6TPE100MAZB			16TQC47M	2012	16TQC47MYFD
	D3L	6TPB100MAV	2009	6TPE100MAZB		D2	16TQC68MY	2012	16TQC68MYF
		2R5TPB330ML	2009	2R5TPE330M			20TQC22M	2012	25TQC22MYFD
		4TPB220ML	2009	4TPE220M			20TQC22MYFD	2015	25TQC22MYFD
		4TPB470ML	2009	4TPE470ML			20TQC47MY	2012	20TQC47MYF
		6TPB150ML	2009	6TPC150M			25TQC15M	2012	25TQC15MYFD
	10TPB100ML	2010	10TPC100M	25TQC22M			2012	25TQC22MYFD	
	D3	4TPB220M	2008	4TPE220M		D3L	16TQC68M	2012	16TQC68MYF
		6TPB150M	2008	6TPC150M			20TQC47M	2012	20TQC47MYF
		10TPB100M	2008	10TPC100M			25TQC33M	2012	25TQC33MYF
	D4	2R5TPB680M	2009	2R5TPE680MFL		D3	16TQC100M	2012	16TQC100MYF
		2R5TPB1000M	2009	2R5TPE1000MF					
		4TPB470M	2009	4TPE470ML					
		4TPB680M	2009	6TPE680MI					
	TPC	B1	2R5TPC56M	2012		6TPB68M			
4TPC47M			2012	6TPC47MB					
6TPC33M			2012	6TPC47MB					
10TPC33MB			2013	12TPG33M					
D2		2R5TPC330M	2009	2R5TPE330M					
		4TPC150M	2009	4TPE150MI					
		4TPC220M	2009	4TPE220M					
TPE	B2	2TPE330MIB	2011	2TPE330MFB					
		2TPE330MAFGB	2011	2TPE330MAFB					
		2R5TPE150MZB	2011	2R5TPE220MZB					
		2R5TPE220MIB	2012	2R5TPE220MFGB					
		4TPE150MUB	2013	4TPE150MAZB					
	D2E	2R5TPE220MC	2012	2R5TPE220M9					
		2R5TPE220M7	2012	2R5TPE330M7					
		2R5TPE470M	2011	2R5TPE470MI					
		4TPE150M	2011	4TPE150MI					
	D3L	2R5TPE680ML	2012	2R5TPE680MFL					
		2R5TPE680MIL	2011	2R5TPE680MFL					
	D4	2R5TPE1000M	2011	2R5TPE1000MF					
		2R5TPE1000MI	2012	2R5TPE1000MF					
		4TPE680M	2011	6TPE680MI					
4TPE680MI		2012	6TPE680MI						
		4TPE680MF	2012	4TPF680MAH					
TPG	B1G	10TPG33M	2011	12TPG33M					
		12TPG33M		-					
TPSF	B2S	11TPSF62MAIG	2012	-					
TH	D2	4THC220M	2013	4THE220M					
	D3L	2R5THB330ML	2010	-					
		10THB100ML	2010	-					
	D4	4THB680M	2013	-					

EOL Models

The following table is a list of the End-Of-Life (EOL) models.

Sales of these items will end as soon as we run out of its stock. We would like to express our appreciation for your business over the years with these products and we hope the new, alternative parts will continue to serve your needs. Thank you very much.

Series	Size code	Models for deletion	Year of deletion	Alternative model	Series	Size code	Models for deletion	Year of deletion	Alternative model		
TPA	C	6TPA47M	2012/9	10TPB47M	TPE	C2	2R5TPE330MFC2	2012/9	2R5TPE330MF		
		10TPA33M	2012/9	10TPB33M			2R5TPE330MIC2	2012/9	2R5TPE330MF		
	D3	4TPA220M	2012/9	4TPE220M			2R5TPE330MCC2	2012/9	2R5TPE330MC		
6TPA150M		2012/9	6TPC150M	2R5TPE330M9C2			2012/9	2R5TPE330M9			
10TPA100M		2012/9	10TPC100M	4TPE220MFC2			2012/9	4TPE220MF			
TPB	B2	4TPB100MV	2012/9	4TPE100MZB			4TPE220MIC2	2012/9	4TPE220MI		
		4TPB150MA	2012/9	4TPE150MAZB			4TPE220MPC2	2012/9	4TPE220MI		
		8TPB33M	2012/9	10TPB33M			6TPE150MIC2	2012/9	6TPE150MI		
	C	2R5TPB220MC	2012/9	4TPE220MI			6TPE150MPC2	2012/9	6TPE150M		
		4TPB150MC	2012/9	6TPE150M			8TPE100MPC2	2012/9	10TPF150ML		
		4TPB220MC	2012/9	4TPE220MI		2R5TPE330MFC	2012/9	2R5TPE330MF			
		6TPB100MC	2012/9	6TPG100MG		2R5TPE330MIC	2012/9	2R5TPE330MF			
		6TPB150MC	2012/9	6TPE150M		2R5TPE330MPC	2012/9	2R5TPE330MF			
		8TPB82MC	2012/9	8TPE100MAZB		4TPE220MIC	2012/9	4TPE220MI			
		10TPB47M	2012/9	10TPC68M		4TPE220MPC	2012/9	4TPE220MI			
		10TPB68MC	2012/9	10TPC68M	6TPE150MPC	2012/9	6TPE150M				
		10TPB220MC	2009/10	-	6TPE220MIC	2012/9	6TPE220MI				
D3L	2R5TPB470ML	2012/9	2R5TPE470MI	6TPE220MPC	2012/9	6TPE220MI					
	2R5TPB680ML	2012/9	2R5TPE680MFL	10TPE150MGC	2012/9	10TPE220ML					
	16TPB47ML	2003/6	16TQC47MYFD	10TPE180MGC	2012/9	10TPE220ML					
D3	2R5TPB330M	2012/9	2R5TPE330M	2TPE330M6	2011	2TPF330M6					
	16TPB47M	2003/6	16TQC47MYFD	2TPE330M7	2011	2R5TPE330M7					
	2R5TPC82M	2012/9	-	2TPE330M9	2011	2R5TPE330M9					
TPC	C1	4TPC56M	2012/9	-	2TPE470M6	2011	2R5TPF470M6L				
		4TPC100M	2012/9	6TPG100MG	2TPE470M7	2011	2R5TPE470M7				
		6TPC68M	2012/9	6TPG100MG	2TPE470M9	2011	2R5TPE470M9				
		6TPC100MC	2012/9	6TPG100MG	6TPE330MAL	2021	6TPE330ML				
		8TPC33M	2012/9	12TPG33M	D2E	2TPF470M6	2012/9	2R5TPF470M6L			
	D2	2R5TPC220M	2012/9	2R5TPE220M	D3L	4TPF470M5EL	2014	-			
		16TPC33M	2003/6	16TQC33MYFD		6TPF330M5EL	2014	-			
		2R5TPD470M	2007/10	2R5TPF470ML	TPG	B1G	4TPG150M	2012/9	6TPG150M		
		2R5TPD470M5	2012/3	ETPF470M5H			6TPG68MG	2012/9	6TPG100M		
		2R5TPD470M6	2012/3	2R5TPF470M6L			2R5TPG220M	2021	ETPS220MUD		
2R5TPD470M8	2007/10	2R5TPF470M7L	6TPG100M	2021			6TPS150MUD				
2R5TPD680M	2007/10	2R5TPF680ML	6TPG100MG	2021			6TPS150MUD				
2R5TPD680M5	2012/3	ETPF680M5H	6TPG100MZGD	2021		6TPS150MUD					
2R5TPD680M6	2012/3	2R5TPF680M6L	8TPG47M	2021		10TPG47M					
2R5TPD680M8	2007/10	2R5TPF680M7L	6TPG220MZG	2014		-					
2R5TPD1000M	2012/3	ETPF1000M6H	2R5TPG220MUG	2021		ETPS220MUD					
2R5TPD1000M8	2012/3	ETPF1000M6H	4TPG220M	2021		4TPS220MUD					
2R5TPD1000M6	2012/3	ETPF1000M6H	6TPG150M	2021	6TPS150MUD						
2R5TPD1000M5	2012/3	ETPF1000M5H	6TPG150MZG	2021	6TPS150MUD						
TPD	D4D	4TPD330M	2007/10	4TPF330ML	TPL	D2T	2R5TPL220MC	2012/9	-		
		4TPD470M	2007/10	4TPF470ML			2R5TPL330M7	2011/7	-		
		4TPD680M	2012/3	4TPF680MAH			All models	2013	-		
		6TPD220M	2007/10	6TPF220ML	D12T	All models	2013	-			
		6TPD330M	2007/10	6TPF330M9L	D15T	All models	2013	-			
		6TPD470M	2012/3	6TPF470MAH	TPLF	D2T	2TPLF470M7	2012/9	-		
		10TPD150M	2007/10	10TPF150ML			2TPLF560M6	2011/7	-		
		2R5TPU22M	2012/9	-			All models	2013	-		
		TPU	S08	4TPU15M	2012/9	-	TPSF	B2S	2TPSF270MC	2012/9	2TPSF270M9G
				6TPU10M	2012/9	-			2TPSF270M9	2012/9	2TPSF270M9G
				2R5TPU22MSI	2011	-			B1S	ETPSF200M9ED	2014
		S09	2R5TPU47MSI	2018	-	TH	D3L	2R5THB470ML	2012/9	6THB470M	
			ETPU100MSI	2018	-			2R5THB680M	2012/9	-	
4TPU15MSI	2011		-	2R5THB1000M	2012/9			-			
4TPU33MSI	2011		-	D4D	2R5THD680M		2012/3	2R5TPF680M6L			
4TPU68MSI	2018		-		4THD470M		2012/9	-			
6TPU10MSI	2018		-		6THD330M		2012/3	6TPF330M9L			
6TPU22MSI	2018		-		TR series		-	TA series			
6TPU47MSI	2018		-	APA	D2A		APA series	2006/4	-		
10TPU47MSI	2018		-	APB	D1		APB series	2006/4	-		
S11	2R5TPU47MSK		2012/9	-	APC		D2	APC series	2009/6	-	
	2R5TPU68MSK	2013	-	APD	D1	APD series	2009/6	-			
	4TPU33MSK	2012/9	-	TQC	B15	35TQC2R7MYF	2016	35TQS6R8MHD			
	4TPU47MSK	2013	-	TPH	A09	ETPH100MHA	2018	-			
	6TPU22MSK	2012/9	-			4TPH68MHA	2018	-			
	6TPU33MSK	2013	-			6TPH47MHA	2018	-			
	2R5TPU100MAI	2011	-			6TPH100MAEA	2018	-			
	4TPU68MAI	2011	-			ATPH33MAHA	2018	-			
	6TPU47MAI	2011	-		ETPH220MABC	2018	-				
	10TPU33MAI	2011	-		ETPH220MAZC	2013	-				
4TPU68MAI	2012/9	-	4TPH150MABC		2018	-					
6TPU47MAI	2012/9	-	6TPH100MABC		2018	-					
6TPU150MAI	2018	-	TQS		B1S	16TQS33MBD	2020	-			
8TPU33MAI	2012/9	-		25TQS10MED		2020	-				
2R5TPE220MPB	2012/9	2R5TPE220MLB		35TQS6R8MHD		2020	-				
TPE	B2	2R5TPE220MDGB	2013	2R5TPE220MFB							
		2TPE330MFB	2021	ETPE330MFB							
		2TPE330MAFB	2021	ETPE330MFB							
		2TPE330MADGB	2021	ETPE330M9GB							

Safety Precautions

When using our products, no matter what sort of equipment they might be used for, be sure to confirm the applications and environmental conditions with our specifications in advance.

Panasonic
INDUSTRY

Panasonic Industry Co., Ltd.
Device Solutions Business Division

1006 Kadoma, Kadoma City, Osaka
571-8506 Japan