

bq2083EVM-001
SBS 1.1 Battery Management Solution
Evaluation Module

User's Guide

IMPORTANT NOTICE

Texas Instruments Incorporated and its subsidiaries (TI) reserve the right to make corrections, modifications, enhancements, improvements, and other changes to its products and services at any time and to discontinue any product or service without notice. Customers should obtain the latest relevant information before placing orders and should verify that such information is current and complete. All products are sold subject to TI's terms and conditions of sale supplied at the time of order acknowledgment.

TI warrants performance of its hardware products to the specifications applicable at the time of sale in accordance with TI's standard warranty. Testing and other quality control techniques are used to the extent TI deems necessary to support this warranty. Except where mandated by government requirements, testing of all parameters of each product is not necessarily performed.

TI assumes no liability for applications assistance or customer product design. Customers are responsible for their products and applications using TI components. To minimize the risks associated with customer products and applications, customers should provide adequate design and operating safeguards.

TI does not warrant or represent that any license, either express or implied, is granted under any TI patent right, copyright, mask work right, or other TI intellectual property right relating to any combination, machine, or process in which TI products or services are used. Information published by TI regarding third-party products or services does not constitute a license from TI to use such products or services or a warranty or endorsement thereof. Use of such information may require a license from a third party under the patents or other intellectual property of the third party, or a license from TI under the patents or other intellectual property of TI.

Reproduction of information in TI data books or data sheets is permissible only if reproduction is without alteration and is accompanied by all associated warranties, conditions, limitations, and notices. Reproduction of this information with alteration is an unfair and deceptive business practice. TI is not responsible or liable for such altered documentation.

Resale of TI products or services with statements different from or beyond the parameters stated by TI for that product or service voids all express and any implied warranties for the associated TI product or service and is an unfair and deceptive business practice. TI is not responsible or liable for any such statements.

Mailing Address:

Texas Instruments
Post Office Box 655303
Dallas, Texas 75265

EVM IMPORTANT NOTICE

Texas Instruments (TI) provides the enclosed product(s) under the following conditions:

This evaluation kit being sold by TI is intended for use for **ENGINEERING DEVELOPMENT OR EVALUATION PURPOSES ONLY** and is not considered by TI to be fit for commercial use. As such, the goods being provided may not be complete in terms of required design-, marketing-, and/or manufacturing-related protective considerations, including product safety measures typically found in the end product incorporating the goods. As a prototype, this product does not fall within the scope of the European Union directive on electromagnetic compatibility and therefore may not meet the technical requirements of the directive.

Should this evaluation kit not meet the specifications indicated in the EVM User's Guide, the kit may be returned within 30 days from the date of delivery for a full refund. **THE FOREGOING WARRANTY IS THE EXCLUSIVE WARRANTY MADE BY SELLER TO BUYER AND IS IN LIEU OF ALL OTHER WARRANTIES, EXPRESSED, IMPLIED, OR STATUTORY, INCLUDING ANY WARRANTY OF MERCHANTABILITY OR FITNESS FOR ANY PARTICULAR PURPOSE.**

The user assumes all responsibility and liability for proper and safe handling of the goods. Further, the user indemnifies TI from all claims arising from the handling or use of the goods. Please be aware that the products received may not be regulatory compliant or agency certified (FCC, UL, CE, etc.). Due to the open construction of the product, it is the user's responsibility to take any and all appropriate precautions with regard to electrostatic discharge.

EXCEPT TO THE EXTENT OF THE INDEMNITY SET FORTH ABOVE, NEITHER PARTY SHALL BE LIABLE TO THE OTHER FOR ANY INDIRECT, SPECIAL, INCIDENTAL, OR CONSEQUENTIAL DAMAGES.

TI currently deals with a variety of customers for products, and therefore our arrangement with the user **is not exclusive**.

TI assumes **no liability for applications assistance, customer product design, software performance, or infringement of patents or services described herein**.

Please read the EVM User's Guide and, specifically, the EVM Warnings and Restrictions notice in the EVM User's Guide prior to handling the product. This notice contains important safety information about temperatures and voltages. For further safety concerns, please contact the TI application engineer.

Persons handling the product must have electronics training and observe good laboratory practice standards.

No license is granted under any patent right or other intellectual property right of TI covering or relating to any machine, process, or combination in which such TI products or services might be or are used.

Mailing Address:

Texas Instruments
Post Office Box 655303
Dallas, Texas 75265

EVM WARNINGS AND RESTRICTIONS

It is important to operate this EVM within the input voltage range of 6 V to 25 V and the output voltage range of 6 V to 25 V.

Exceeding the specified input range may cause unexpected operation and/or irreversible damage to the EVM. If there are questions concerning the input range, please contact a TI field representative prior to connecting the input power.

Applying loads outside of the specified output range may result in unintended operation and/or possible permanent damage to the EVM. Please consult the EVM User's Guide prior to connecting any load to the EVM output. If there is uncertainty as to the load specification, please contact a TI field representative.

During normal operation, some circuit components may have case temperatures greater than 60°C. The EVM is designed to operate properly with certain components above 60°C as long as the input and output ranges are maintained. These components include but are not limited to linear regulators, switching transistors, pass transistors, and current sense resistors. These types of devices can be identified using the EVM schematic located in the EVM User's Guide. When placing measurement probes near these devices during operation, please be aware that these devices may be very warm to the touch.

Mailing Address:

Texas Instruments
Post Office Box 655303
Dallas, Texas 75265

Read This First

About This Manual

This user's guide describes the bq2083/bq29311 evaluation module (EVM) and contains the EVM schematic, bill of materials, assembly drawing, and board layouts.

How to Use This Manual

This document contains the following chapters:

- Chapter 1—Introduction
- Chapter 2—bq2083/bq29311-Based Circuit Module and Schematic
- Chapter 3—Circuit Module Physical Layouts and Bill of Materials
- Chapter 4—bq2083/bq29311EVM-001 Circuit Module Performance Specification Summary
- Chapter 5—EVM Hardware and Software Setup
- Chapter 6—Operation

FCC Warning

This equipment is intended for use in a laboratory test environment only. It generates, uses, and can radiate radio frequency energy and has not been tested for compliance with the limits of computing devices pursuant to subpart J of part 15 of FCC rules, which are designed to provide reasonable protection against radio frequency interference. Operation of this equipment in other environments may cause interference with radio communications, in which case the user at his own expense will be required to take whatever measures may be required to correct this interference.

Trademarks

Windows™ is a trademark of Microsoft. All other trademarks are the property of their respective owners.

Electrostatic Sensitive Devices



This EVM contains components that can potentially be damaged by electrostatic discharge. Always transport and store the EVM in its supplied ESD bag when not in use. Handle using an antistatic wristband. Operate on an antistatic work surface. For more information on proper handling, refer to SSYA008.

Contents

1	Introduction	1-1
1.1	Features	1-2
1.2	Kit Contents	1-2
1.3	Ordering Information	1-2
2	bq2083/bq29311-Based Circuit Module and Schematic	2-1
2.1	Pin Descriptions	2-2
2.2	bq2083/bq29311EVM-001 Circuit Module Schematic	2-3
3	Circuit Module Physical Layouts and Bill of Materials	3-1
3.1	Board Layout	3-2
3.2	Bill of Materials	3-3
4	bq2083/bq29311 Circuit Module Performance Specification Summary	4-1
5	EVM Hardware and Software Setup	5-1
5.1	Software Installation	5-2
5.2	Hardware Connection	5-2
5.2.1	Connecting the bq2083/bq29311EVM-001 Circuit Module to a Battery Pack	5-2
5.2.2	PC Interface Connection	5-2
6	Operation	6-1
6.1	Starting the Program	6-2
6.2	Setting Programmable bq2083 and bq29311 Options	6-4
6.3	Calibration of a bq2083/bq29311-Based Module Using the EV2200-83 Software	6-6
6.4	Direct Access Communication	6-7

Figures

2-1	bq2083EVM-001 Schematic	2-3
3-1	bq2083EVM-001 Layout	3-2
5-1	bq2083/bq29311 Circuit Module Connection to Cells and System Load/Charger	5-2
6-1	SBS Data Screen	6-2
6-2	SBS Data Screen—Status Bit Window	6-3
6-3	Flash Data Screen	6-4
6-4	SBS Data Screen—AFE Configuration and Module Calibration Locations	6-5
6-5	Calibration Screen	6-6
6-6	Pro Screen	6-7

Tables

1-1	Ordering Information	1-2
3-1	bq2083EVM-001 Bill of Materials	3-3
4-1	Performance Specification Summary	4-1
5-1	Circuit Module to EV2200 Connections	5-3
6-1	Example Log File	6-3

Introduction

This EVM is a complete evaluation system for the bq2083/bq29311 battery management system. The EVM includes one bq2083/bq29311 circuit module, a current sense resistor, a thermistor, an EV2200 PC interface board for gas gauge interface, a PC serial cable, and Windows™-based PC software. The circuit module includes one bq2083 IC, one bq29311 IC and all other necessary components onboard. The circuit monitors and predicts capacity, performs cell balancing, monitors critical parameters, protects the cells from overcharge, over discharge, short circuit, and overcurrent in 3- or 4-series cell Li-Ion or Li-Polymer battery packs. The circuit module connects directly across the cells in a battery. With the EV2200 interface board and software, the user can read the bq2083 data registers, program the chipset for different pack configurations, log cycling data for further evaluation and evaluate the overall functionality of the bq2083/bq29311 solution under different charge and discharge conditions.

Topic	Page
1.1 Features	1-2
1.2 Kit Contents	1-2
1.3 Ordering Information	1-2

1.1 Features

- Complete evaluation system for the bq2083 SBS 1.1-compliant advanced gas gauge and the bq29311 analog front end and protection IC
- Populated circuit module for quick setup
- PC software and interface board for easy evaluation
- Software that allows data logging for system analysis

1.2 Kit Contents

- bq2083/bq29311 circuit module
- Sense resistor
- EV2200 PC interface board
- Set of evaluation software disks entitled EV2200-83
- PC serial cable
- Set of support documentation

1.3 Ordering Information

Table 1-1. Ordering Information

EVM Part Number	Chemistry	Configuration	Capacity
bq2083EVM-001	Li-Ion	3 or 4 cell	Any

bq2083/bq29311-Based Circuit Module and Schematic

The bq2083/bq29311-based circuit module is a complete and compact example solution of a bq2083 and bq29311 circuit for battery management and protection of Li-Ion or Li-Polymer packs. The circuit module incorporates a bq2083 battery monitor IC, bq29311 AFE and protection IC and all other components necessary to accurately predict the capacity of 3- or 4-series cells.

Contacts on the circuit module provide direct connection to the cells (BAT-, 1P, 2P, 3P, BAT+) and the serial communications port (SMBC, SMBC). The system load and charger connect across PACK+ and PACK-.

The $\overline{\text{SAFE}}$ output reflects the state of the safety output from the bq2083 and has extra ESD protection just for evaluation purposes.

Topic	Page
2.1 Pin Descriptions	2-2
2.2 bq2083/bq29311 Circuit Module Schematic	2-3

2.1 Pin Descriptions

BAT-	-ve connection of first (bottom) cell
1P	+ve connection of first (bottom) cell
2P	+ve connection of second cell
3P	+ve connection of third cell
BAT+	+ve connection of fourth (top) cell
SMBC	Serial communication port clock
SMBD	Serial communication data port
SAFE	bq2083 safety output
PACK-	Pack negative terminal
VSS	Pack negative terminal
PACK+	Pack positive terminal



Circuit Module Physical Layouts and Bill of Materials

This chapter contains the board layout and assembly drawings for the bq2083/bq29311 circuit module.

Topic	Page
3.1 Board Layout	3-2
3.2 Bill of Materials	3-3

3.1 Board Layout

Figure 3–1 shows the dimensions, PCB layers, and assembly drawing for the bq2083/bq29311 module.

Figure 3–1. bq2083EVM-001 Layout

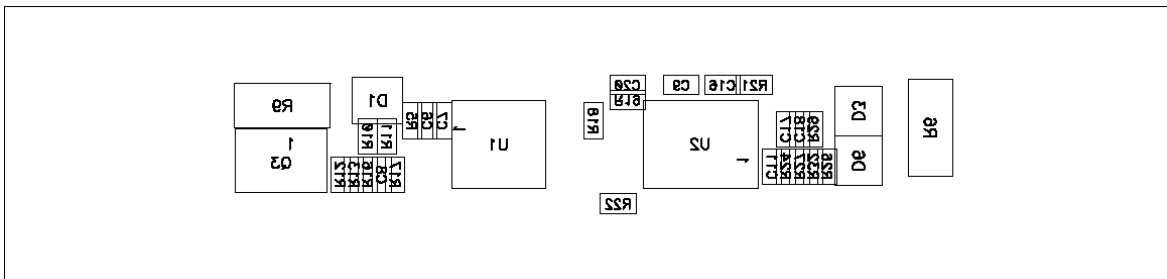
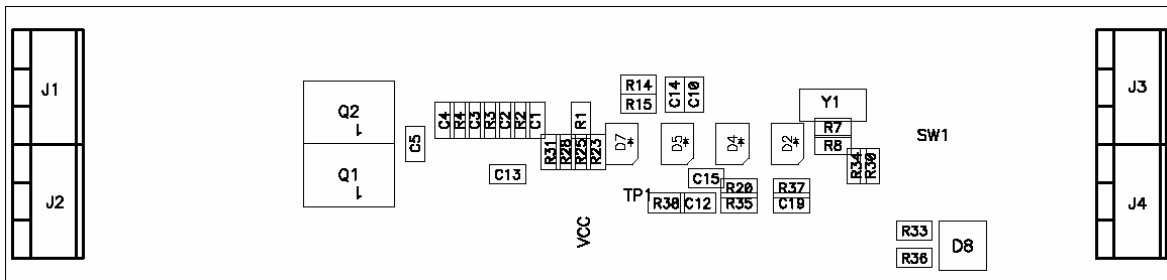
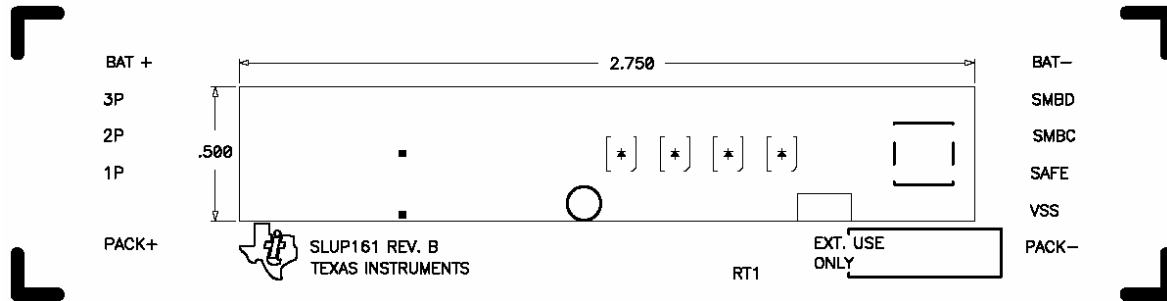

3.2 Bill of Materials

Table 3–1 lists materials required for the bq2083/bq29311 circuit module.

Table 3–1. bq2083EVM-001 Bill of Materials

Qty -001	Reference	Description	Size	MFR	Part Number
7	C1, C2, C3, C4, C6, C7, C20	Capacitor, ceramic, .01 μ F, 25 V, X7R	603	Any	
1	C8	Capacitor, ceramic, 0.047 μ F, 16 V, X7R	603	Any	
4	C13, C15, C16, C19	Capacitor, ceramic, 0.47 μ F, 16 V, X7R	603	Any	
1	C17	Capacitor, ceramic, 2200 pF, 16 V, X7R	603	Any	
1	C18	Capacitor, ceramic, 150 pF, 16 V, X7R	603	Any	
6	C5, C9, C10, C11, C12, C14	Capacitor, ceramic, 0.1 μ F, 16 V, X7R	603	Any	
1	D1	Diode, dual ultra fast, series, BAV99, 200 mA, 70 V	SOT23	Fairchild	BAV99
4	D2, D4, D5, D7	Diode, LED, green, gullwing, GW Type, 20 mA, 7.5 mcd typ	SMT	Panasonic	LN1361C
3	D3, D6, D8	Diode, Zener, 5.6 V, 350 mW	SOT23	Diodes, Inc.	BZX84C5v6T
4	J1, J2, J3, J4	Terminal Block, 3 pin, 6 A, 3,5 mm	TH	OST	ED1515
3	Q1, Q2, Q3	MOSFET, P-channel, 30 V, 8.0 A, 20 m Ω	S08	Siliconix	Si4435DY
11	R1, R2, R3, R4, R5, R18, R26, R27, R32, R33, R36	Resistor, chip, 100 Ω , 1/16 W, 5%	603	Std	Std
5	R10, R12, R16, R30, R34	Resistor, chip, 1 M Ω , 1/16 W, 5%	603	Std	Std
3	R11, R13, R17	Resistor, chip, 5.1 k Ω , 1/16 W, 5%	603	Std	Std
3	R14, R15, R24	Resistor, chip, 100 Ω , 1/16 W, 5%	603	Std	Std
2	R20, R21	Resistor, chip, 10 Ω , 1/16 W, 5%	603	Std	Std
4	R23, R25, R28, R31	Resistor, chip, 470 Ω , 1/16 W, 5%	603	Std	Std
2	R29, R37	Resistor, chip, 61.9 k Ω , 1/16 W, 1%	603	Std	Std

Qty -001	Reference	Description	Size	MFR	Part Number
1	R35	Resistor, chip, 8.45 k Ω , 1/16 W, 1%	603	Std	Std
1	R6 ***	Resistor, chip, 0.02 Ω , 1 W, 1%	2512	Vishay/Dale	WSL-2512-R02

Table 3-1. bq2083EVM-001 Bill of Materials (Continued)

Qty -001	Reference	Description	Size	MFR	Part Number
3	R19, R22, R38	Resistor, chip, 100 k Ω , 1/16 W, 5%	603	Std	Std
0	R7	Resistor, chip, 100 k Ω , 1/16 W, 5%	603	Std	Std
0	R8	Resistor, chip, 0 Ω , 1/16 W, 5%	603	Std	Std
1	R9	Resistor, chip, 300 Ω , 1 W, 5%	2512	Vishay/Dale	CRCW2512LR301
1	RT1	Thermistor, 10 k Ω , 8.5 A trip, 2.6 W	TH	SEMTIC	103AT
1	SW1	Switch, push button, momentary, N.O. low profile	TH	Panasonic	EVQPLHA15
1	TP1	Jack, test point, clr	TH	Farnell	240-333
1	U1	IC, bq29311pw	24TSSOP	TI	bq29311PW
1	U2	IC, Advanced Gas Gauge, bq2083DBT	38TSSOP	TI	bq2083DBT
1	Y1	Crystal, 32.768 kHz, 7-12 pF capacitance	SMT	Epson or KDS	FC2550000201 or ZE00019
1	--	PCB			Any

Assembly Notes:

- 1) This assembly is ESD sensitive.
- 2) This assembly shall comply with IPC-A-610 class 2 or better.
- 3) This assembly must be clean of flux residues and contaminants.
- 4) Use of no-clean flux is not acceptable.

bq2083/bq29311 Circuit Module Performance Specification Summary

This section summarizes the performance specifications of the bq2083/bq29311 Circuit Module. Table 4–1 gives the performance specifications of the circuit.

Table 4–1. Performance Specification Summary

Specification	Min	Typ	Max	Units
Input Voltage Pack+ to Pack–	6.0		25	V
Charge and Discharge Current			See Note	A

Note: Maximum currents are determined by the value of the sense resistor used and the short circuit threshold setting of the bq29311



EVM Hardware and Software Setup

This section describes how to install the bq2083EVM–001 PC software and how to connect the different components of the EVM.

Topic	Page
5.1 Software Installation	5-2
5.2 Hardware Connection	5-2

5.1 Software Installation

The following steps install the EV2200-83 software:

- 1) Insert disk 1 into a 3 1/2 inch floppy drive.
- 2) Select the 3 1/2 inch drive using My Computer or File Manager.
- 3) Double-click on the Setup.exe icon.
- 4) The setup program prompts for the remaining disks and installs a Windows™ application group.

5.2 Hardware Connection

There are three hardware components to the bq2083EVM-001: the bq2083/bq29311 circuit module, the EV2200 PC interface board, and the PC.

5.2.1 Connecting the bq2083/bq29311 Circuit Module to a Battery Pack

Figure 5-1 shows how to connect the bq2083/bq29311 circuit module to the cells, and system load/charger.

The cells should be connected in the following order.

- 4-Cell Pack: BAT-, BAT+, 1P, 2P and then 3P. (see Section 2.1 for definitions)
- 3-Cell Pack: BAT-, BAT+, 1P, 2P and then connect BAT+ and 3P together.

Figure 5-1. bq2083/bq29311 Circuit Module Connection to Cells and System Load/Charger

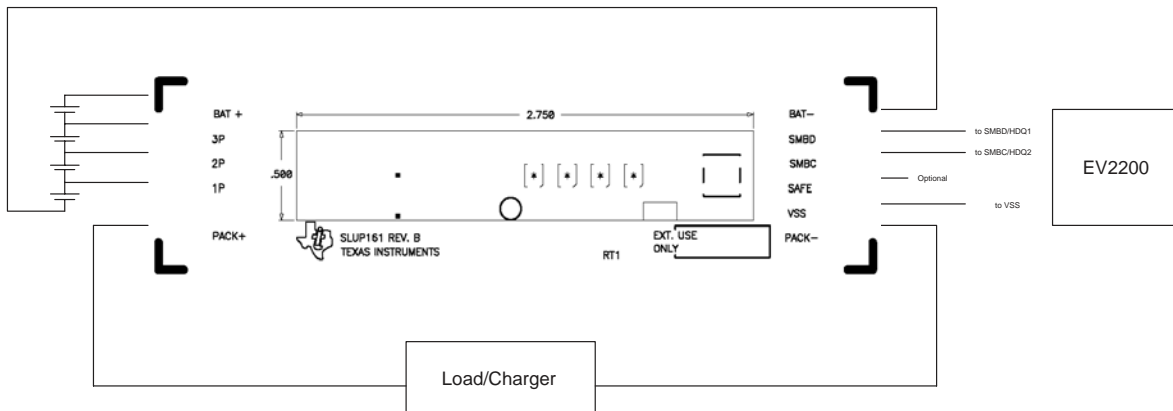

5.2.2 PC Interface Connection

The following steps configure the hardware for interface to the PC:

- 1) Connect the bq2083/bq29311-based smart battery to the EV2200 using wire leads as in Table 5-1.

Table 5–1. Circuit Module to EV2200 Connections

bq2083/bq29311-Based Battery	EV2200
SMBD	SMBD/HDQ1
SMBC	SMBC/HDQ2
VSS	VSS

2) Connect the PC serial cable to the EV2200 and the PC COM port.

The bq2083EVM-001 is now set up for operation.



Operation

This section details the operation of the EV2200-83 software.

Topic	Page
6.1 Starting the Program	6-2
6.2 Setting Programmable bq2083 and bq29311 Options	6-4
6.3 Calibration of a bq2083/bq29311-Based Module Using the EV2200-83 Software	6-6
6.4 Direct Access Communication	6-7

6.1 Starting the Program

Run EV2200-83 from the Start | Programs | Texas Instruments | EV2200-83 menu sequence. The SBS Data screen appears. Data begins to appear as the indicator scans down the screen, as seen pointing to Charging Current in Figure 6-1. To disable the scan feature select | Options | Scan| Off |.

Figure 6-1. SBS Data Screen

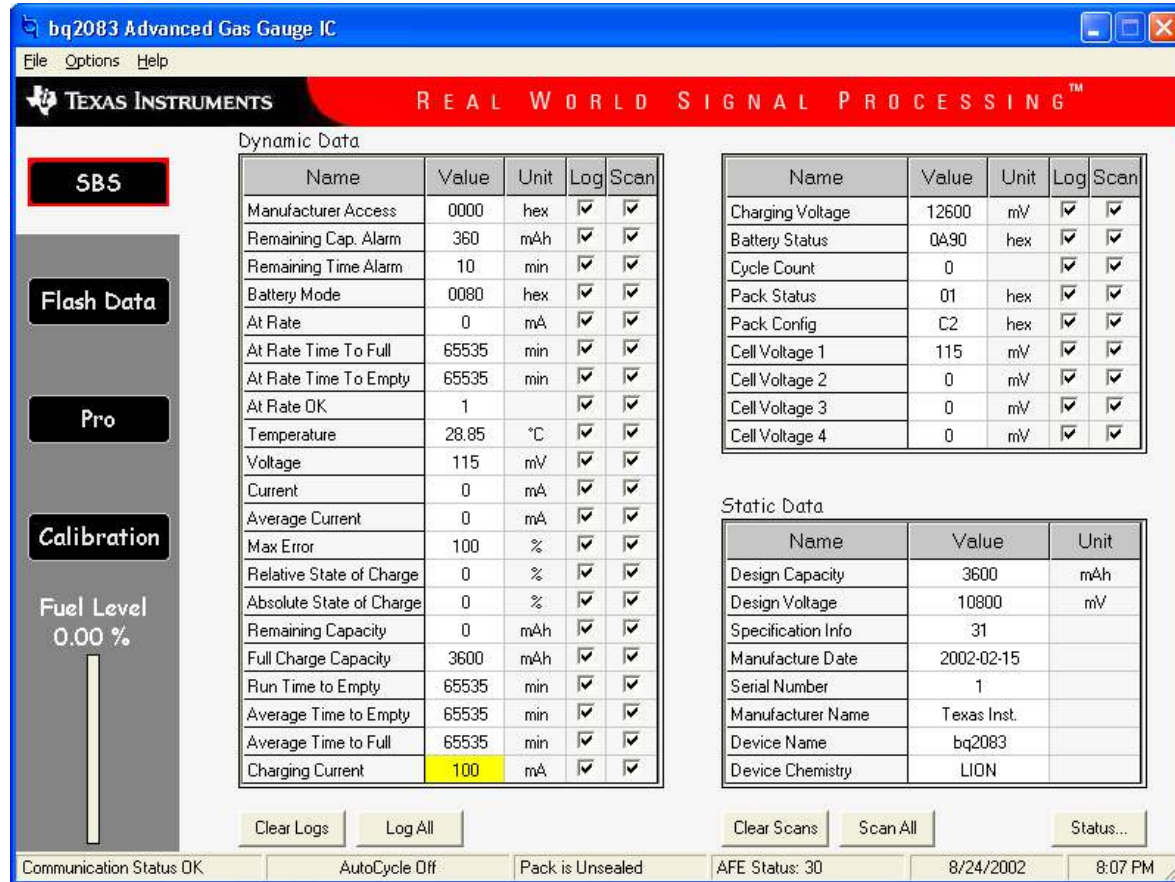

This screen shows the SBS data set along with additional ManufacturersAccess() command information such as individual cell measurements. Static data is shown in a box at the bottom right which, by clicking on the Status... button, changes to show the status bits of the bq2083 and bq29311.

Figure 6–2. SBS Data Screen—Status Bit Window

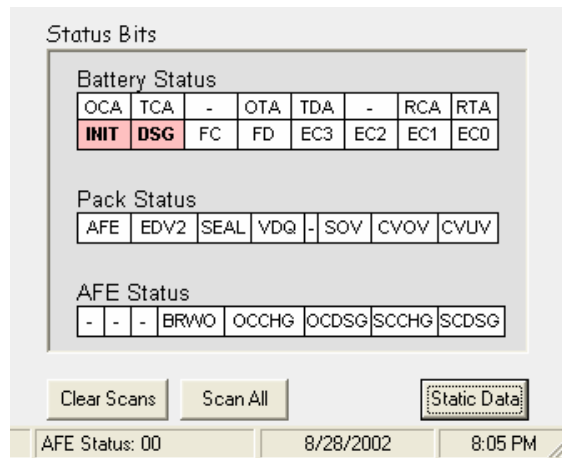

SBS Data can be logged for further evaluation by using the File | Start Data Log menu options. Then enter the desired file name and click on [OK]. An example of a data log file is shown below. To stop the data log, follow the same sequence. The logging period can be changed via | Options | Set Logging Options |.

Table 6–1. Example Log File

EV2X00–83 Version: 1.0.0 Texas Instruments bq2083 Gas Gauge

8/28/2002 20:08

Design Capacity: 3600

Design Voltage: 10800

Specification Info: 31

Mfg Date(yyyy–mm–dd): 2002–02–15

Serial Number: 1

Mfr Name: Texas Instruments

Device Name: bq2083

Device Chemistry: LION

Sample	Stamp	Elapsed(s)	Temp	Voltage	Current	AvgCurr	RSOC	RemCap
1	8:09:09 PM	10	30.05	11922	1438	1195	64	2295
2	8:09:19 PM	21	30.25	11926	1402	1286	64	2300
3	8:09:29 PM	31	29.95	11931	1369	1330	64	2304
4	8:09:39 PM	41	30.15	11696	0	631	64	2304
5	8:09:49 PM	51	30.25	11928	1409	745	64	2305
6	8:09:59 PM	61	30.15	11932	1368	1015	64	2309
7	8:10:09 PM	71	30.15	11935	1331	1190	64	2313

6.2 Setting Programmable bq2083 and bq29311 Options

The bq2083 data flash comes configured per the default settings detailed in the bq2083 data sheet. Special attention should be paid to make sure the settings are correctly changed for the pack and application the bq2083/bq29311 solution is being evaluated with.

IMPORTANT:

The correct setting of these options is essential to get the best performance. The settings can be configured using the Flash Data Screen.

Figure 6–3. Flash Data Screen

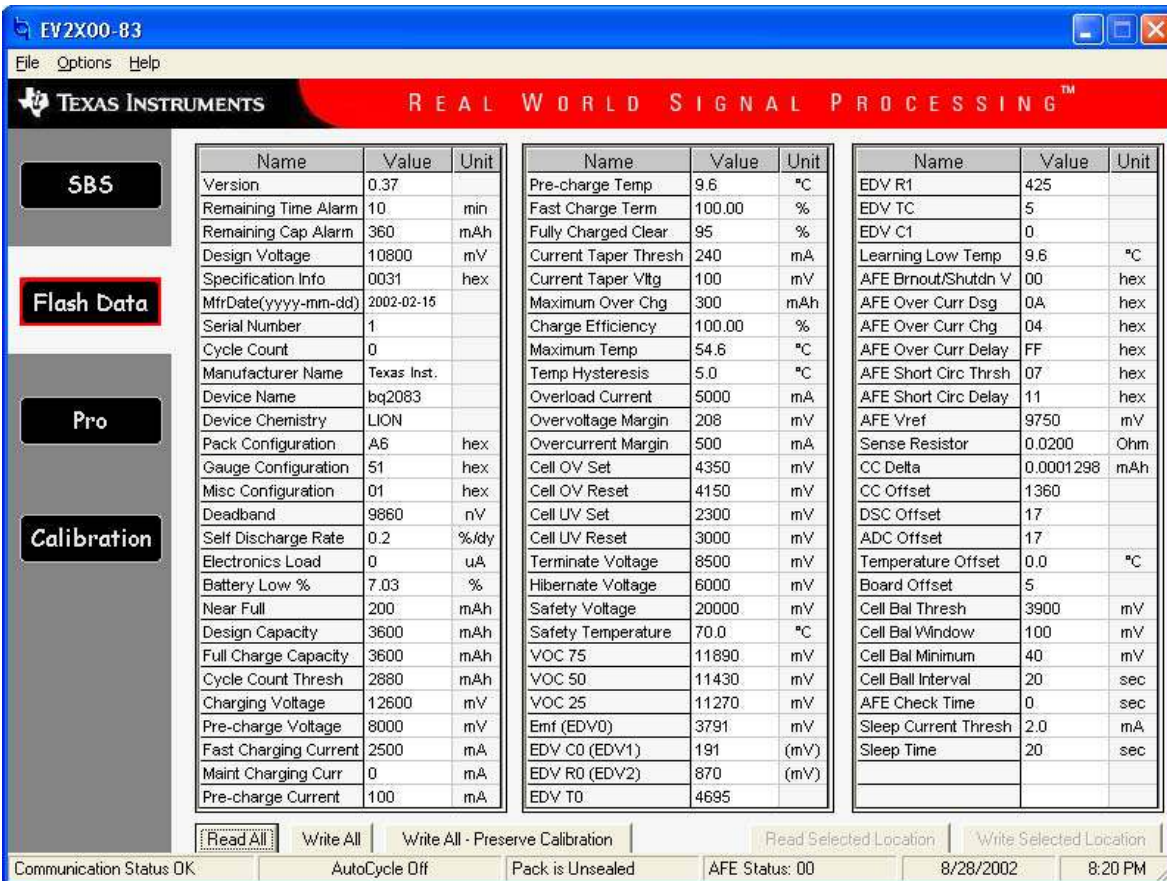

To read all the data from the bq2083 data flash, click on | Read All |. To read only a selected location, click on the desired location and the | Read Selected Location | button is activated. When this button is clicked the data is read and the screen is updated.

The same procedure can be followed for the writing of all the data flash or just a specific location.

The data flash configuration can be saved to a file by selecting | File | Save gas gauge constants | and entering a file name. A data flash file can also be retrieved in this way and written to the bq2083 using the | Write All | button.

If the calibration data already in the bq2083 is required to be preserved the | Write All – Preserve Calibration | button should be used.

The configuration information of the bq29311 and module calibration data is also held in the bq2083 data flash as highlighted below.

Figure 6–4. SBS Data Screen—AFE Configuration and Module Calibration Locations

Name	Value	Unit
EDV R1	425	
EDV TC	5	
EDV C1	0	
Learning Low Temp	9.6	°C
AFE Brnout/Shutdn V	00	hex
AFE Over Curr Dsg	0A	hex
AFE Over Curr Chg	04	hex
AFE Over Curr Delay	FF	hex
AFE Short Circ Thrsh	07	hex
AFE Short Circ Delay	11	hex
AFE Vref	9750	mV
Sense Resistor	0.0200	Ohm
CC Delta	0.0001298	mAh
CC Offset	1360	
DSC Offset	17	
ADC Offset	17	
Temperature Offset	0.0	°C
Board Offset	5	
Cell Bal Thrsh	3900	mV
Cell Bal Window	100	mV
Cell Bal Minimum	40	mV
Cell Bal Interval	20	sec
AFE Check Time	0	sec
Sleep Current Thrsh	2.0	mA
Sleep Time	20	sec

Selected Location Write Selected Location

8/28/2002 8:20 PM

AFE Configuration Data

Calibration Data

6.3 Calibration of a bq2083/bq29311-Based Module Using the EV2200-83 Software

As part of the calibration data there is a board offset parameter. The EV2200–83 software allows the board offset to be measured. An average of several modules should be taken and then this value entered in all like modules.

The calibration screen offers a simple to use interface for this procedure.

Follow the screen down and the instructions that are present. Click [Start] to begin the test, and further instructions appear for that particular calibration procedure until it is complete.

Figure 6–5. Calibration Screen

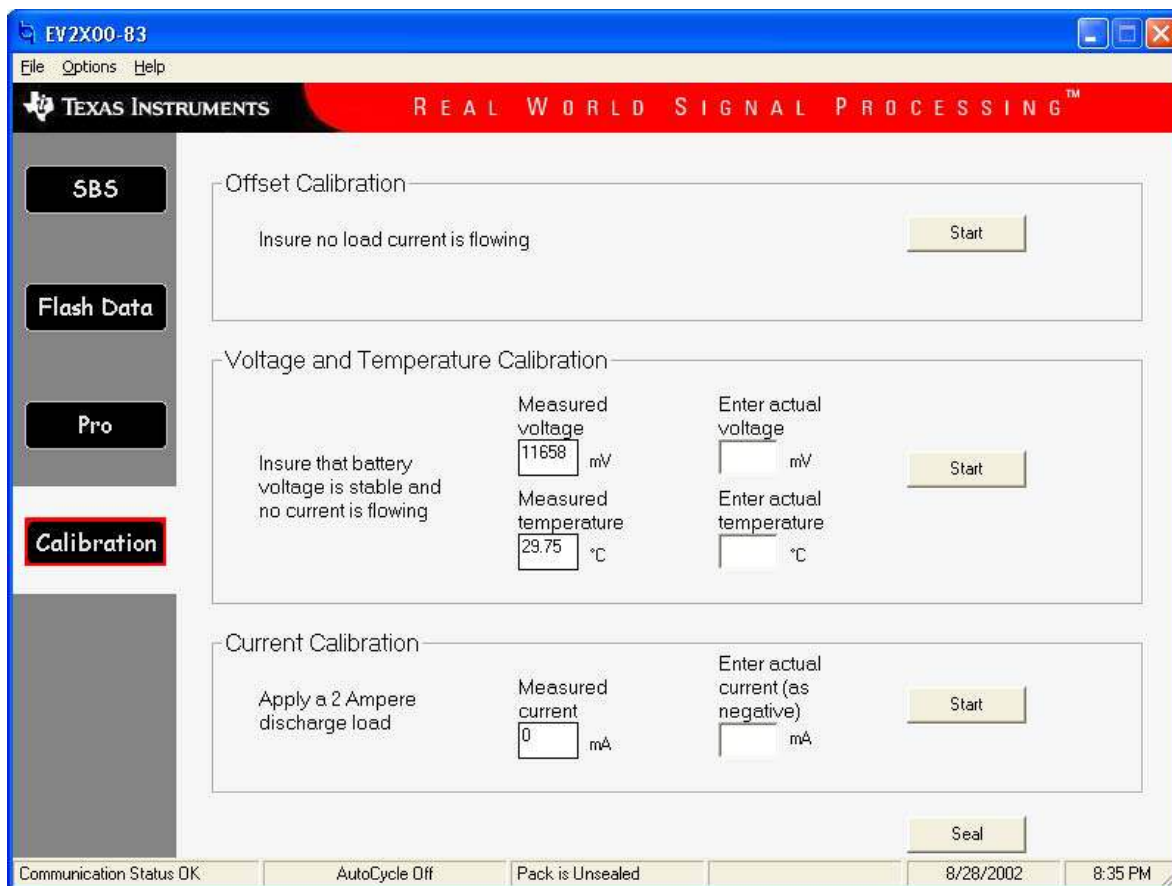

6.4 Direct Access Communication

The bq2083 allows access to the various internal registers through the Pro screen. Here individual byte or block reads and block writes can be performed.

Figure 6–6. Pro Screen

