

THIS DOCUMENT IS SUBJECT TO CHANGE WITHOUT NOTICE. IT IS CONFIDENTIAL AND A PROPERTY OF Amphenol LTW. DISCLOSURE TO THIRD PARTY HAS TO BE AUTHORIZED BY Amphenol LTW.

REV.	ECN NO.	DATE	SIGN	DESCRIPTION
A		2018/04/16	Brady	New Initial
B	C230039	2023/01/10	Jiahe Lin	 *3

MSDS-XXBFFM-SL8EXX

XX: No. Of Pin

XX:01~99Meters
 01:01Meter
 02:02Meters
 :
 99:99Meters

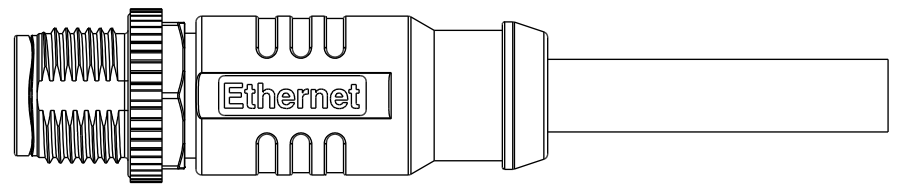
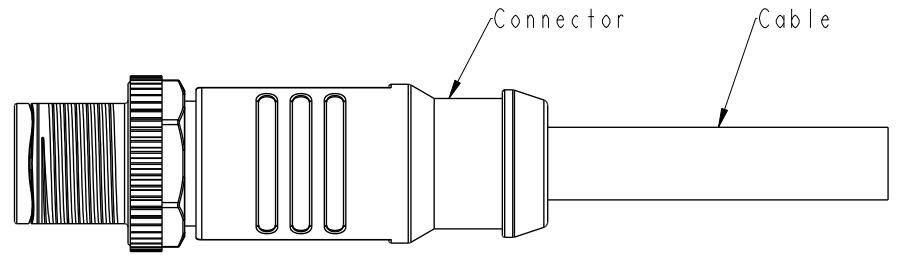
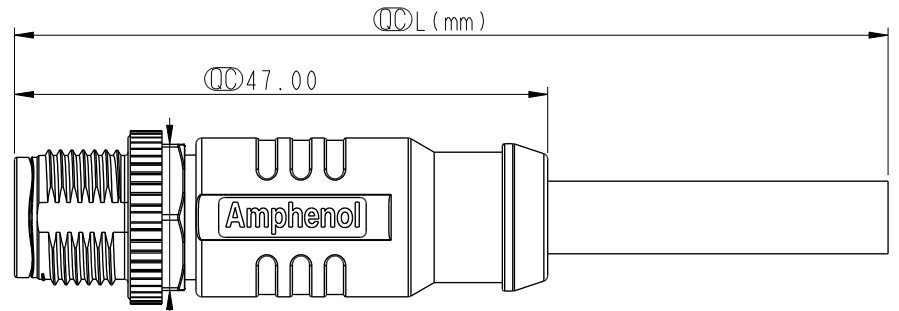
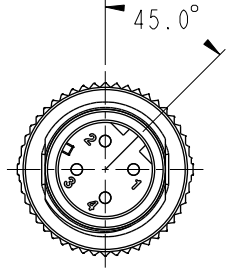

- Note:
- * RoHS Compliant
 - *  Important dimension
 - * Waterproof rate: IP68, mated 1m/24h, IP69K mated
 - * Connector
 - Housing: Thermoplastic, Black
 - Pin: Copper alloy, Gold plated
 - Nut: Metal
 - Outer mold: Thermoplastic, Black
 - * Cable: CAT-5E, 24#*2P+AL/MY+B+F, OD=6.4mm, TPU Jacket, Blue
 - * Cable length tolerance: 1M: +50/-0 mm
 - 1M < L ≤ 3M: +100/-0 mm
 - 3M < L ≤ 5M: +150/-0 mm
 - 5M < L ≤ 10M: ±100 mm
 - 10M < L ≤ 20M: ±200 mm
 - 20M < L ≤ 30M: ±300 mm
 - 30M < L ≤ 99M: ±500 mm

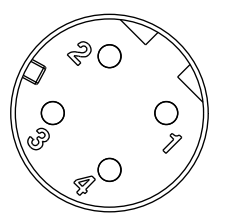

Shield	Braid	編織	
4	Green	綠	Twist
2	White/Green	白/綠	
3	Orange	橘	Twist
1	White/Orange	白/橘	
Connector	Wire Color		
Pin Out			

Pin Assignments Front View

UNIT:mm
 TOLERANCE
 ±0.5mm

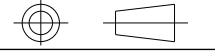

TITLE N SEN, M12 D -SHLD, SCREW CABLE W/O SR, F, F, MOLDING			
SCALE 3:2	SIZE A4	SHEET 1 OF 2	
REV. B	WC-REV. A.2	 : Inspection item	

Amphenol LTW
 安費諾亮泰企業股份有限公司

ITEM NO	DRAWN BY Brady	DATE 2018/04/16
DWG NO  MSDS-XXBMMM-SL8EXX	CHECKED BY Neo	DATE 2018/04/16
CUSTOMER ALTW	APPROVED BY Max	DATE 2018/04/16