

ASS'Y P/N	I.D. FOR CABLE
SF3282-XXSG-520	Ø .200
SF3282-XXSG-530	Ø .300
SF3282-XXSG-540	Ø .400

KEY: A
B
C
D

NO. OF CONTACTS: 2-9

NOTES:
1. ONE (1) OF EACH KIT IS IN A SEALED BAG WITH AN INSTRUCTION SHEET.
2. BAG LABEL STATES "CONXALL", PART NUMBER, DATE CODE AND P/N BARCODE

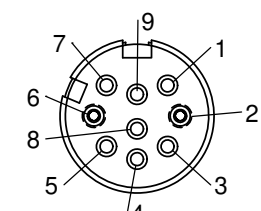

FACE VIEW
SF3282-2ASG-5XX
POS. 1, 3, 4, 5, 7, 8,
& 9 MOLDED HALF
CLOSED

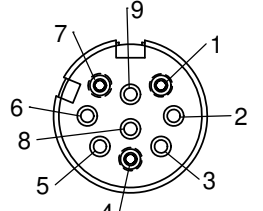

FACE VIEW
SF3282-3ASG-5XX
POS. 2, 3, 5, 6, 8 & 9
MOLDED HALF CLOSED

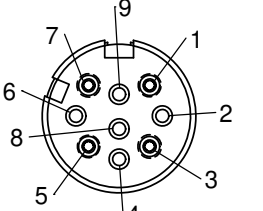

FACE VIEW
SF3282-4ASG-5XX
POS. 2, 4, 6, 8 & 9
MOLDED HALF CLOSED

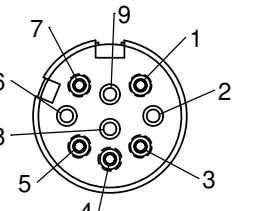

FACE VIEW
SF3282-5ASG-5XX
POS. 2, 6, 8 & 9
MOLDED HALF CLOSED

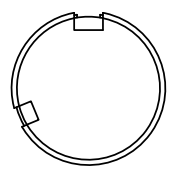

"B" KEY

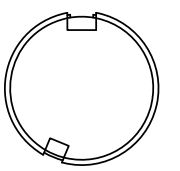

"C" KEY

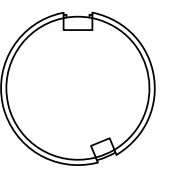

"D" KEY

ALL CONTACT POSITIONS ARE THE SAME AS THE "A" KEY AS SHOWN

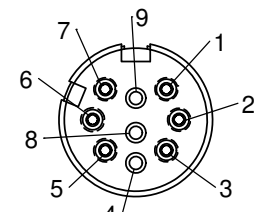
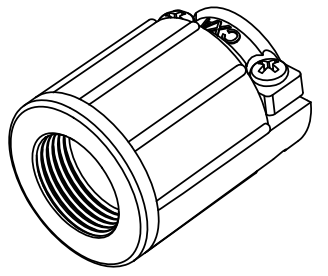

FACE VIEW
SF3282-6ASG-5XX
POS. 4, 8 & 9
MOLDED HALF CLOSED

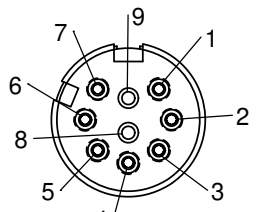

FACE VIEW
SF3282-7ASG-5XX
POS. 8 & 9 MOLDED
HALF CLOSED

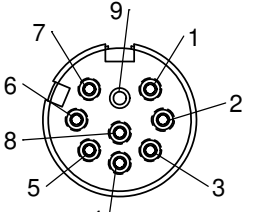

FACE VIEW
SF3282-8ASG-5XX
POS. 9 MOLDED
HALF CLOSED

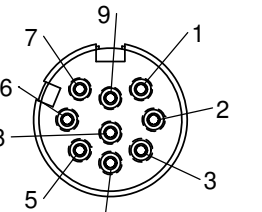

FACE VIEW
SF3282-9ASG-5XX

BACKSHELL KIT (SEE CHART)

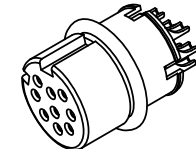
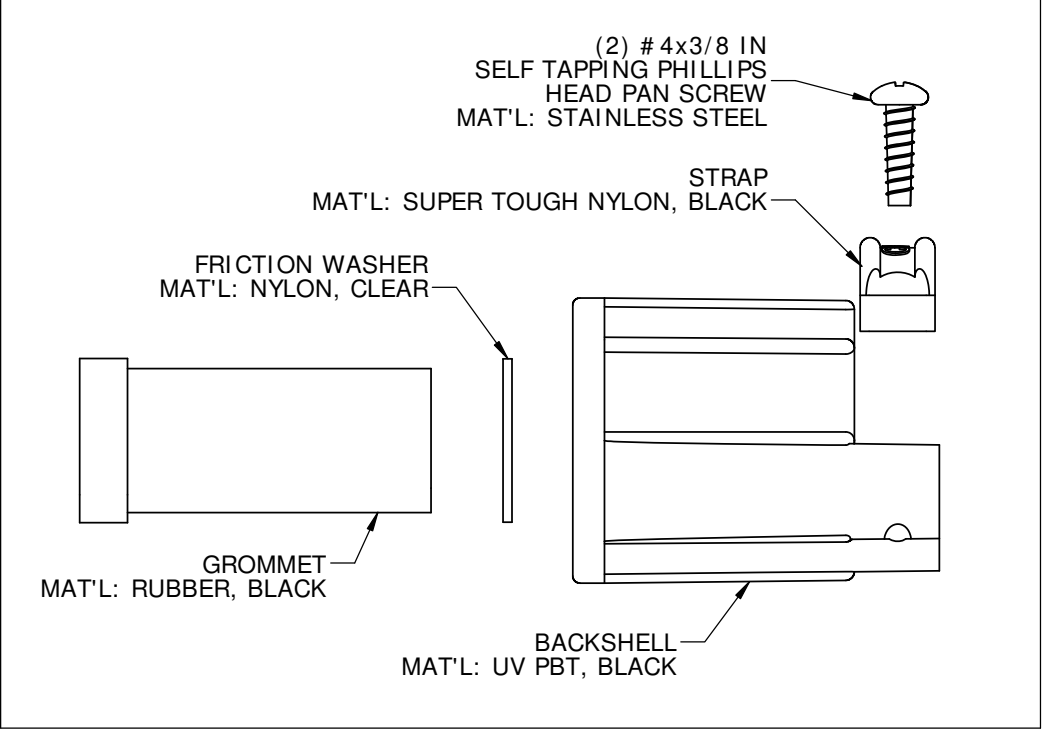

2-9 POSITION A,B,C,D KEY INSERT KIT

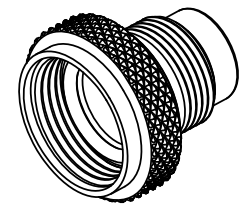
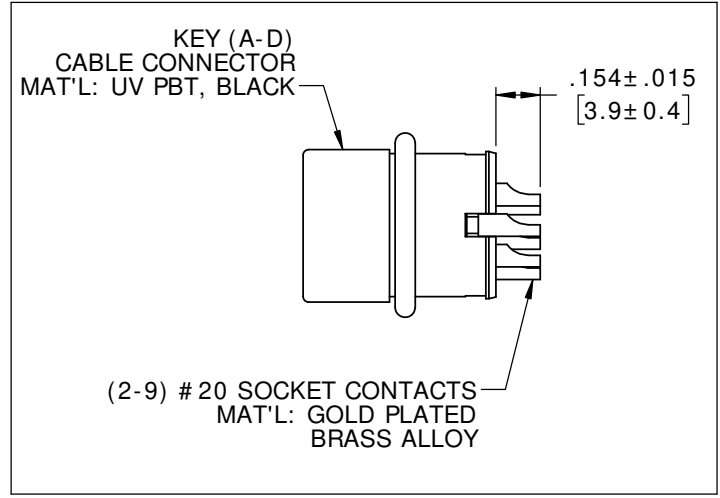

HOUSING KIT

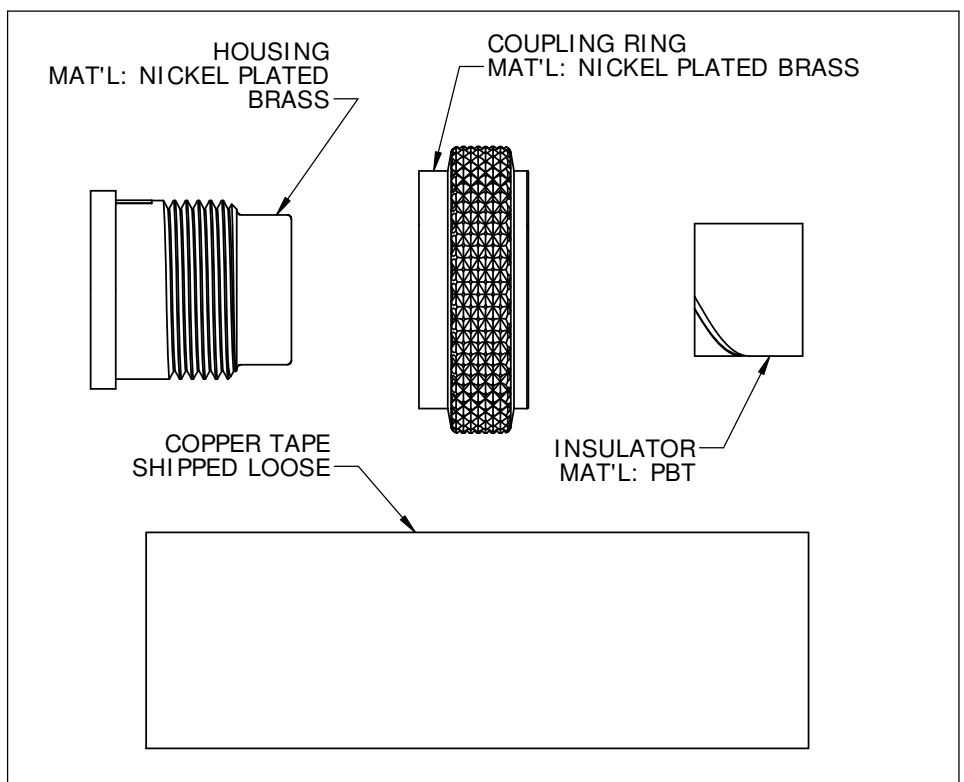

DIMENSIONS IN BRACKETS [] ARE IN MILLIMETERS UNLESS INDICATED

CUSTOMER PRINT

PART NUMBER: SF3282-XXSG-5XX

CUSTOMER APPROVAL

THIS DOCUMENT CONTAINS CONFIDENTIAL INFORMATION PROPRIETARY TO CONXALL CORPORATION. ANY REPRODUCTION, DISCLOSURE, OR USE OF THIS DOCUMENT / INFORMATION IS EXPRESSLY PROHIBITED UNLESS AUTHORIZED IN WRITING BY CONXALL CORPORATION.

APPROVED BY: _____
DATE: _____

A	MA	10-09-19	DRAWING CREATED PER ECR 9439
REV.	INIT.	DATE	DESCRIPTION
	MA	10-09-19	ORIG. DRAWN BY: DATE: MA 10-09-19
ALL INFORMATION ILLUSTRATED IS THE PROPERTY OF CONXALL CORPORATION. UNAUTHORIZED DUPLICATION OR DISTRIBUTION OF THIS DOCUMENT IS PROHIBITED.			 601 E. WILDWOOD VILLA PARK, IL 60181
ALL UNITS ARE IN FEET, INCHES, FRACTION OF INCHES AND DECIMALS.			
APPROVED BY:		TITLE: CONNECTOR ASSEMBLY KIT (4-9) #20 SOCKET SOLDER CONTACTS SHIELDED MULTI-CON-X STANDARD PRODUCT	
SCALE	SIZE	SHEET	
NTS	B		
FILE:	DIRECTORY:	PART NUMBER:	REV
SF3282-XXSG-5XX	SLW	SF3282-XXSG-5XX	A

RoHS COMPLIANT