

ACAR0301-SG3



3.05 x 1.6 x 0.55 mm
 RoHS/RoHS II Compliant
 MSL - N/A

FEATURES

- Multiband 1561~1610 MHz ceramic chip
- Low VSWR
- Linear polarization

APPLICATIONS

- Tracking, Geolocation
- IoT sensors
- Wearables

Electrical Characteristics

Item	Spec
Center Frequency (After matching)	1561~1610 MHz
Bandwidth	49 MHz typ
VSWR	≤ 2.0
Impedance	50Ω
Peak Gain	1.69 dBi @ 1561 MHz
	-1.81 dBi @ 1575.42 MHz
	1.43 dBi @ 1602 MHz
Polarization	Linear

Dimensions

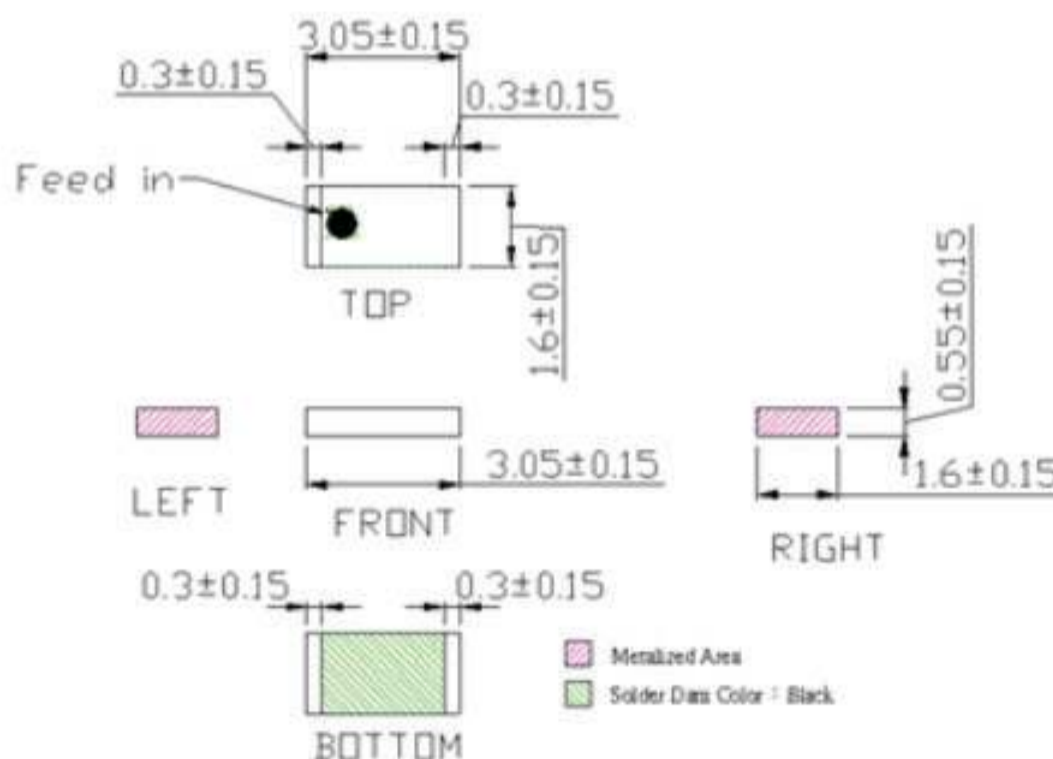

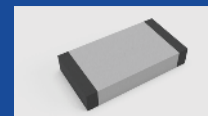

ACAR0301-SG3



3.05 x 1.6 x 0.55 mm
 RoHS/RoHS II Compliant
 MSL - N/A

Evaluation Board and Matching Circuits

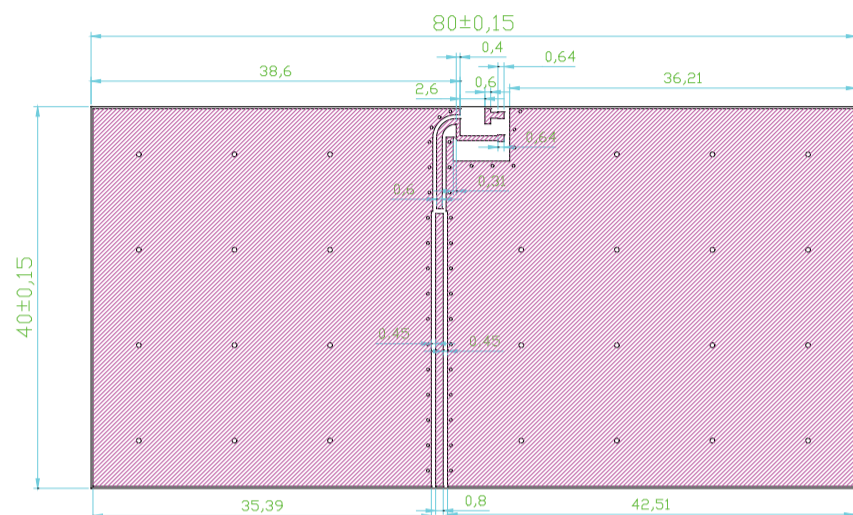

Top View

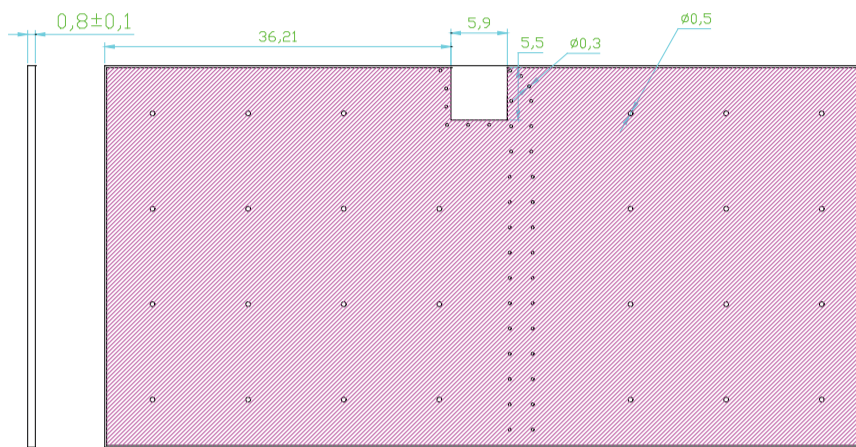

Bottom View

Unit: mm

Recommended Layout

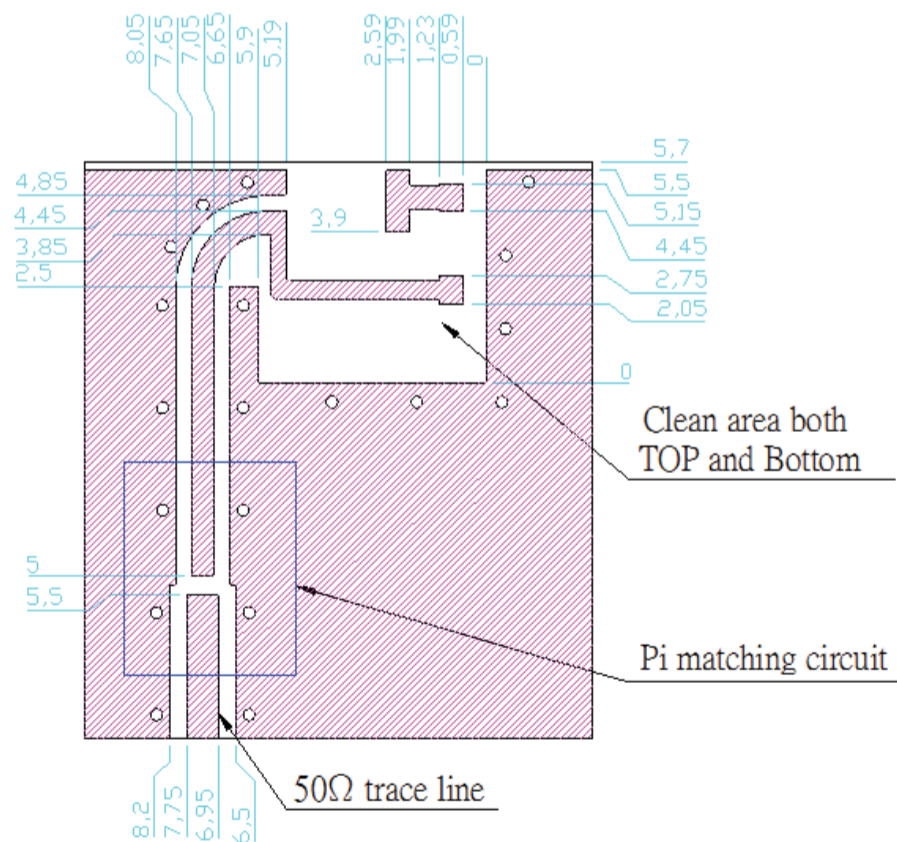

Matching Circuit

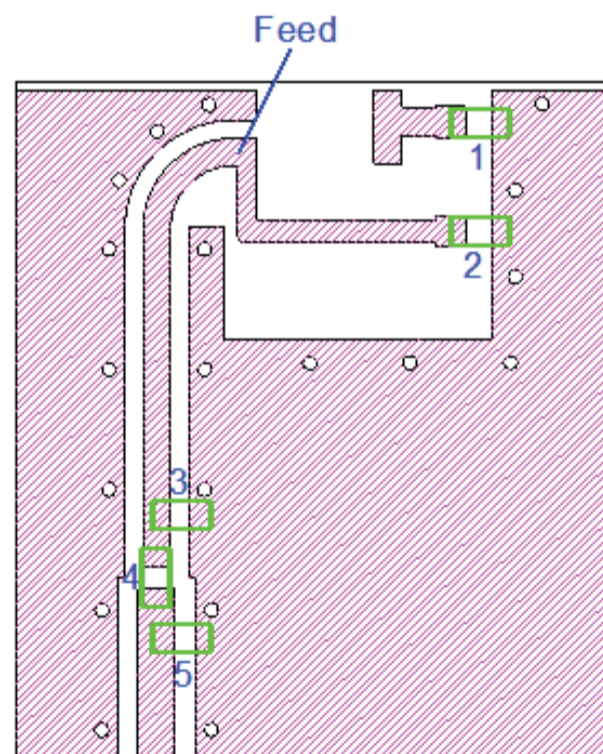

Matching Circuit Component					
NO.	1	2	3	4	5
Description	2pF	1pF	3.3pF	0Ω	N.A

GNSS/GPS/GLONASS/BEIDOU SMD Chip Antenna

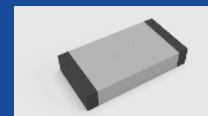

ACAR0301-SG3



3.05 x 1.6 x 0.55 mm
 RoHS/RoHS II Compliant
 MSL - N/A

Antenna Response –Return Loss S11

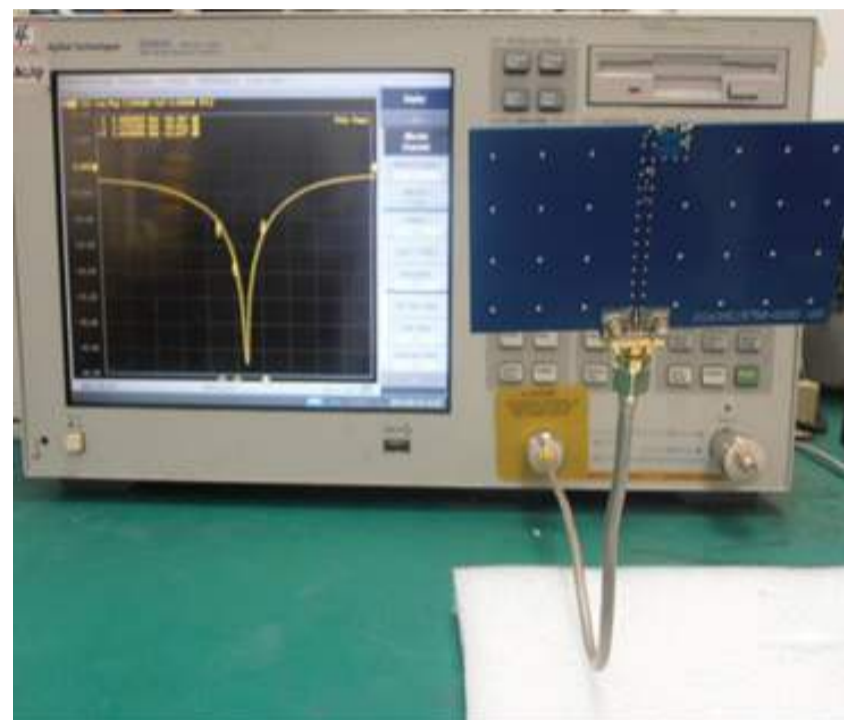
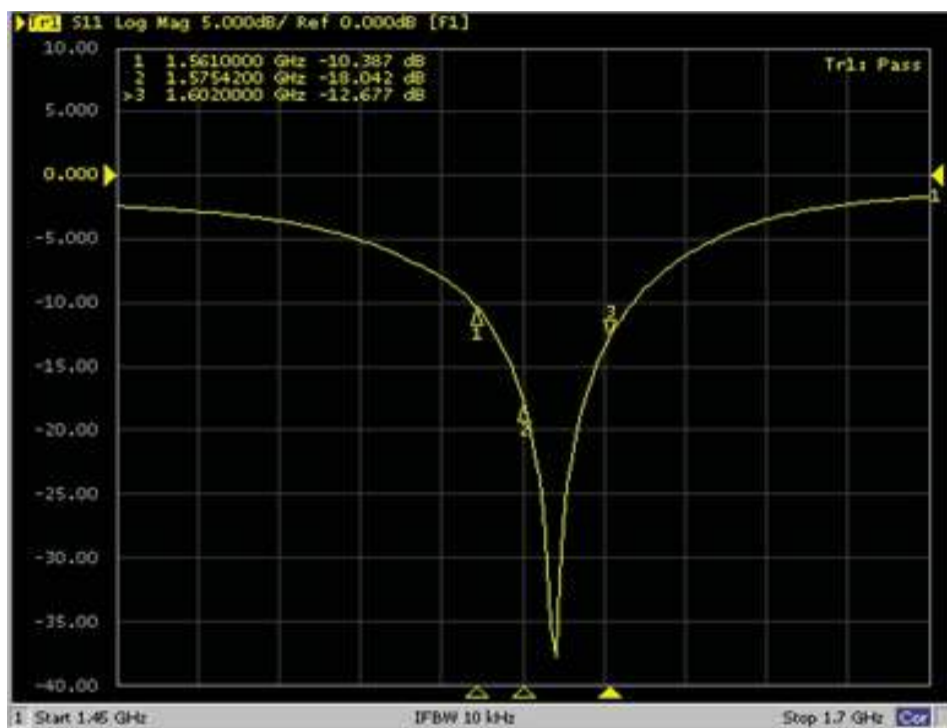

Frequency(MHz)	1561	1575.42	1602
S11(dB)	-10.38	-18.04	-12.67

Efficiency

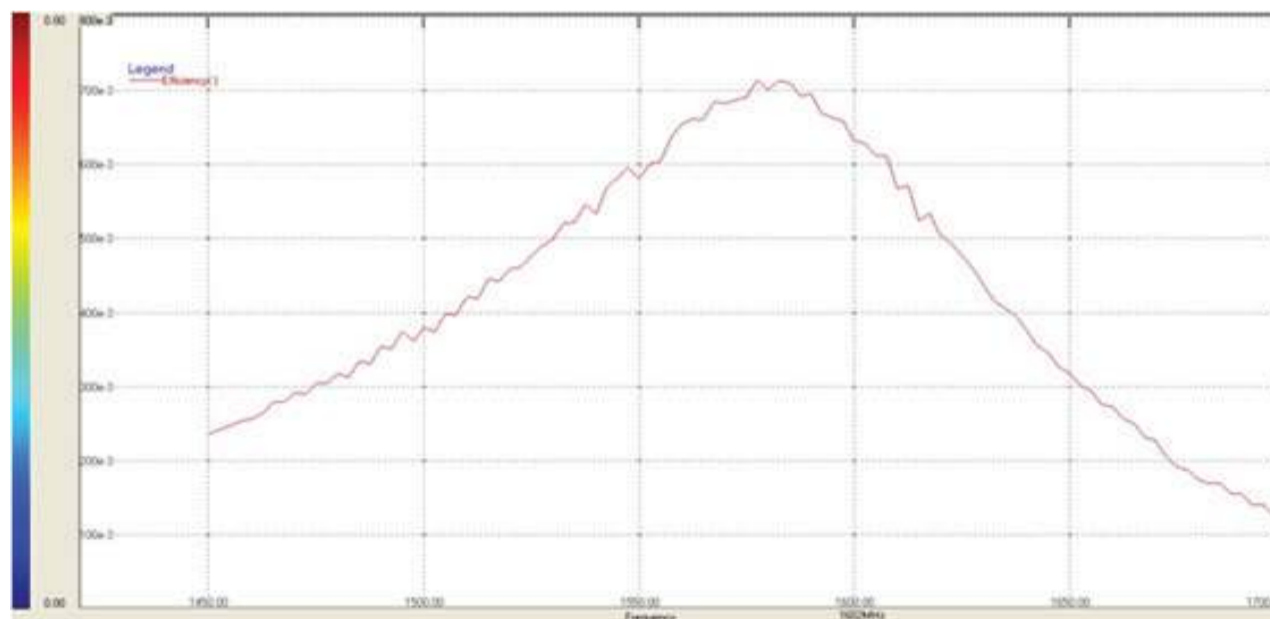

Frequency(MHz)	Efficiency (%)
1561.00	65.74
1575.42	70.06
1602.00	63.27



5101 Hidden Creek Ln Spicewood TX 78669
 Phone: 512-371-6159 | Fax: 512-351-8858
 For terms and conditions of sales, please visit:
www.abracon.com

REVISED: 08.15.2018

ABRACON IS
 ISO9001-2015
 CERTIFIED

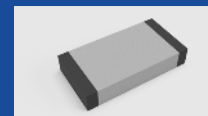

ACAR0301-SG3



3.05 x 1.6 x 0.55 mm
 RoHS/RoHS II Compliant
 MSL - N/A

Gain

Average Gain

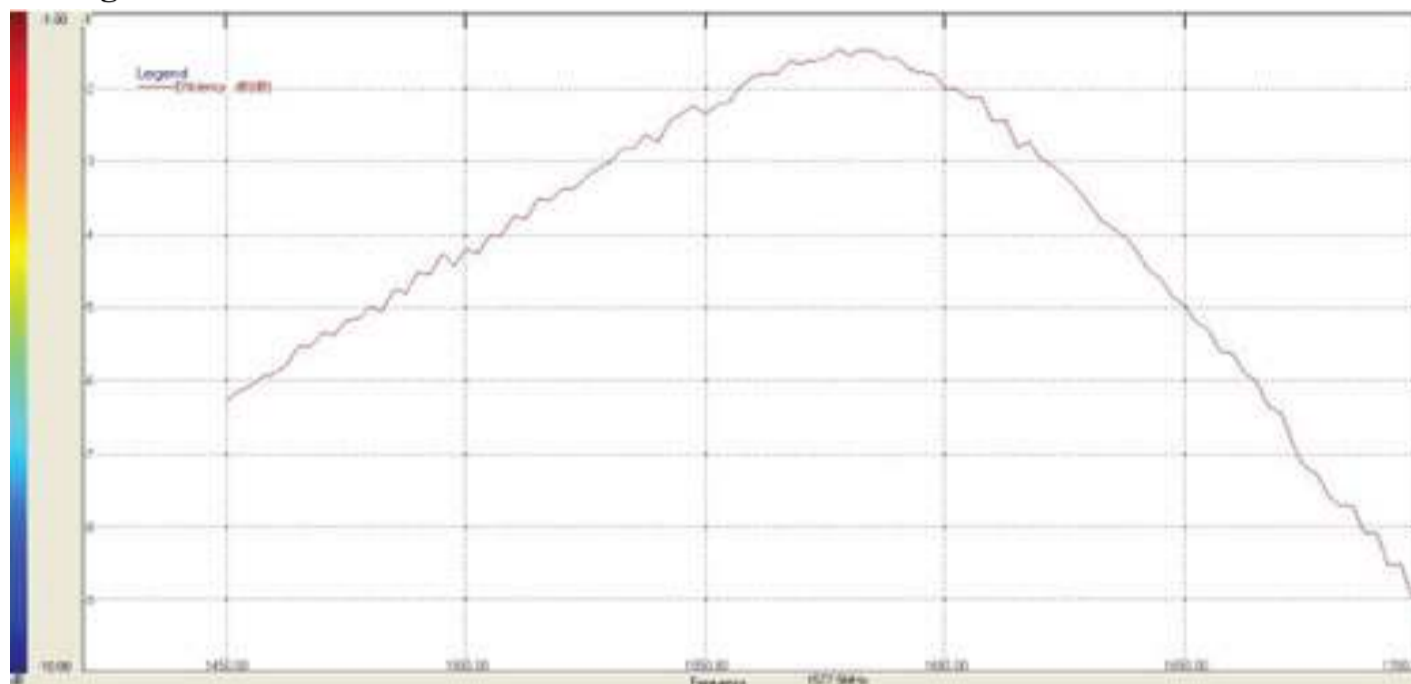

Peak Gain

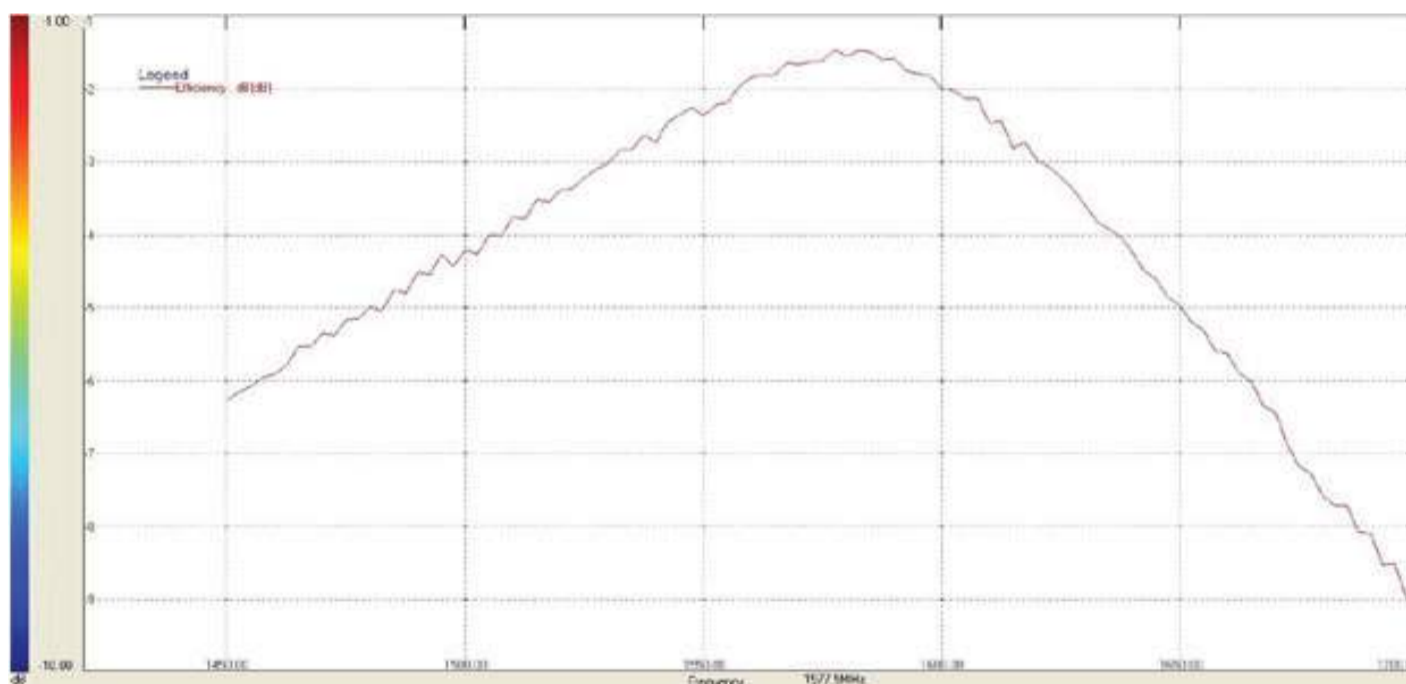

Frequency(MHz)	Avg. Gain	Peak Gain
1561.00	-1.82	1.69
1575.42	-1.54	-1.81
1602.00	-1.98	1.43

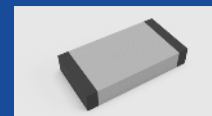

ACAR0301-SG3



3.05 x 1.6 x 0.55 mm
RoHS/RoHS II Compliant
MSL - N/A

Radiation Pattern

2D Radiation Patterns

1561 MHz

1575.42MHz

1602 MHz

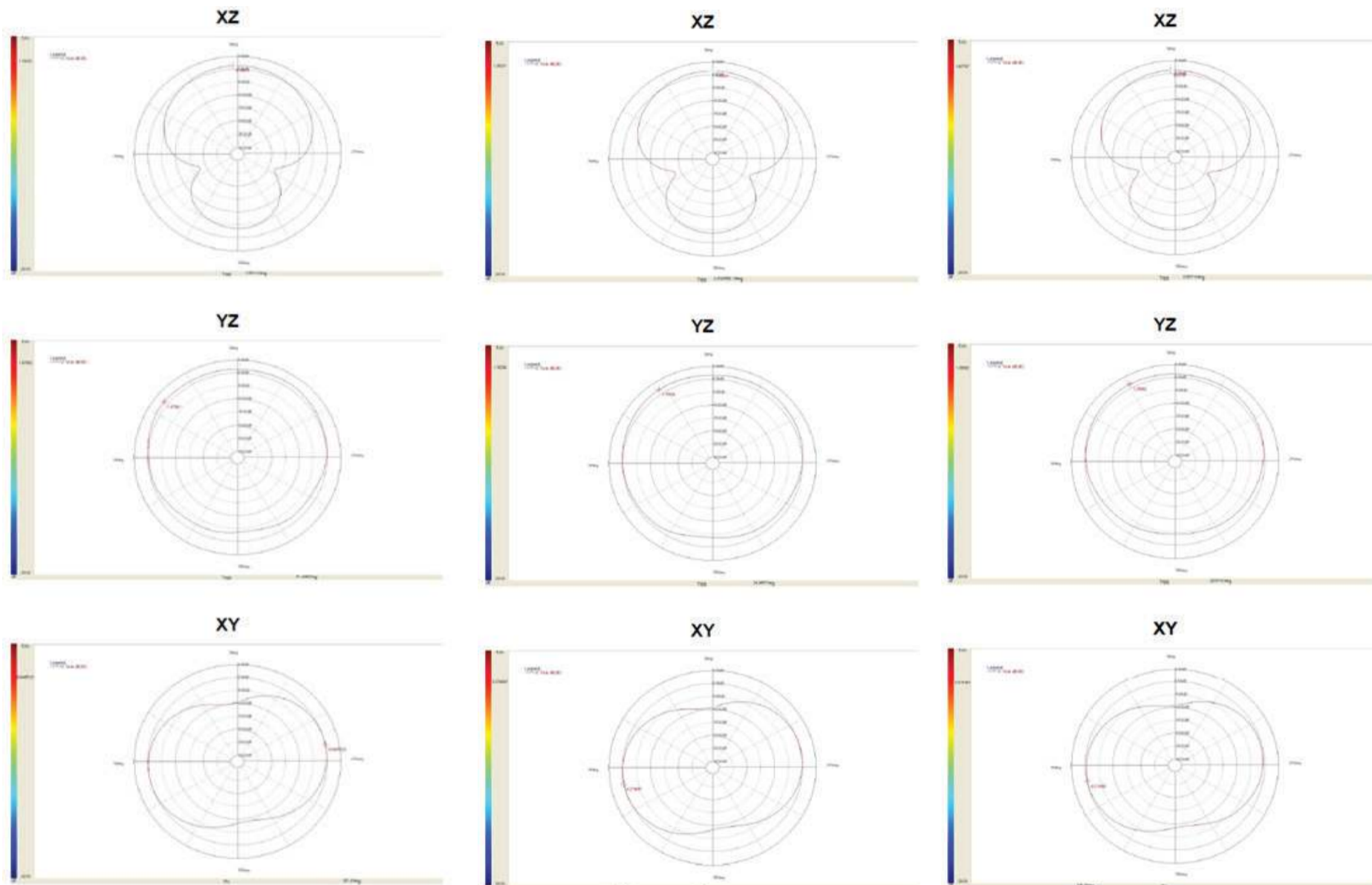

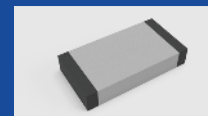

ACAR0301-SG3



3.05 x 1.6 x 0.55 mm
RoHS/RoHS II Compliant
MSL - N/A

Radiation Pattern

3D Radiation Patterns

1561 MHz

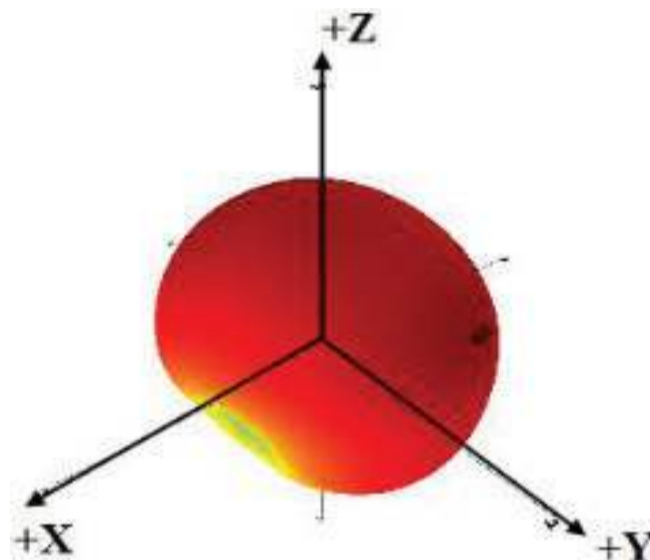
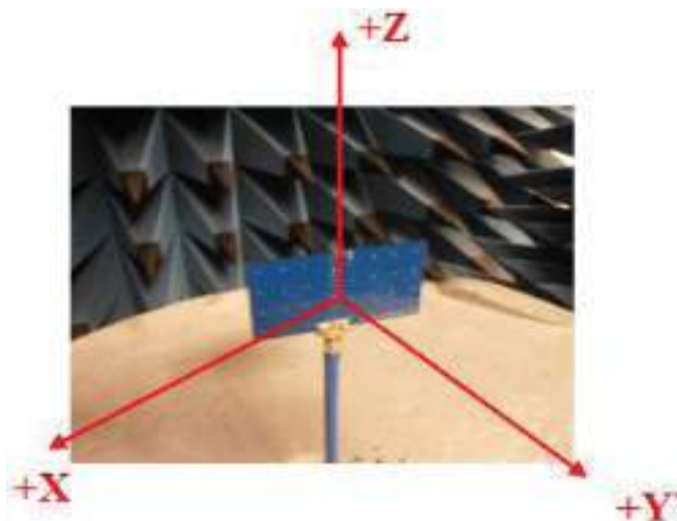

1575.42MHz

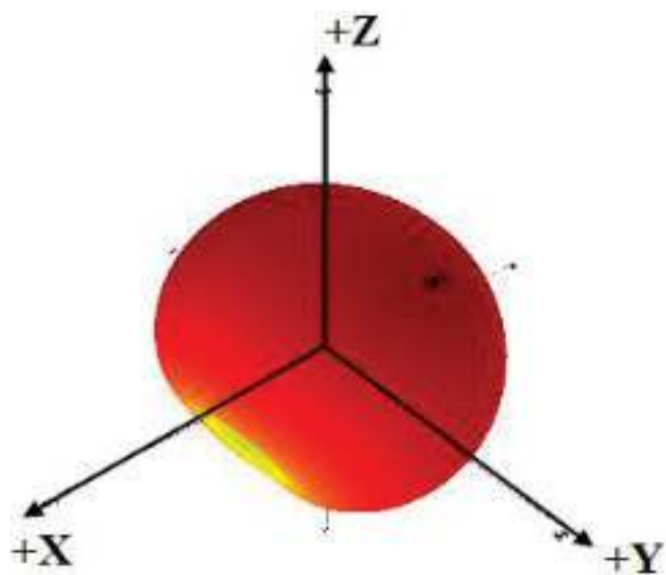

1602 MHz

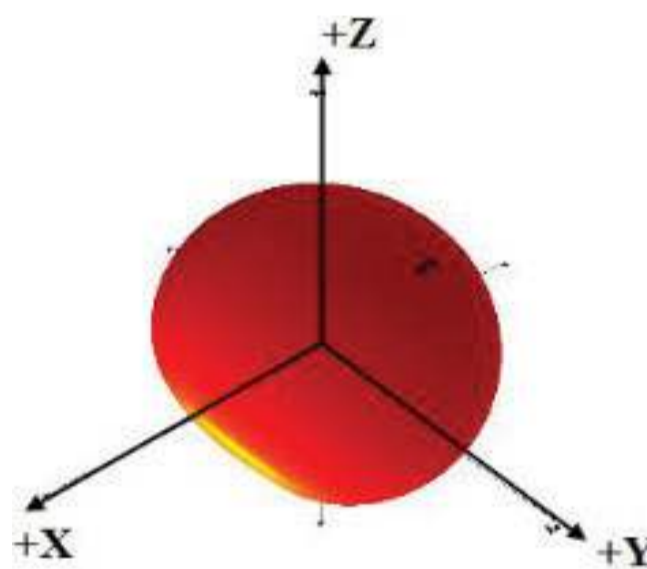

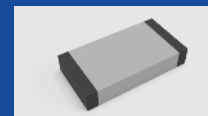

ACAR0301-SG3



3.05 x 1.6 x 0.55 mm
RoHS/RoHS II Compliant
MSL - N/A

Reflow Profile

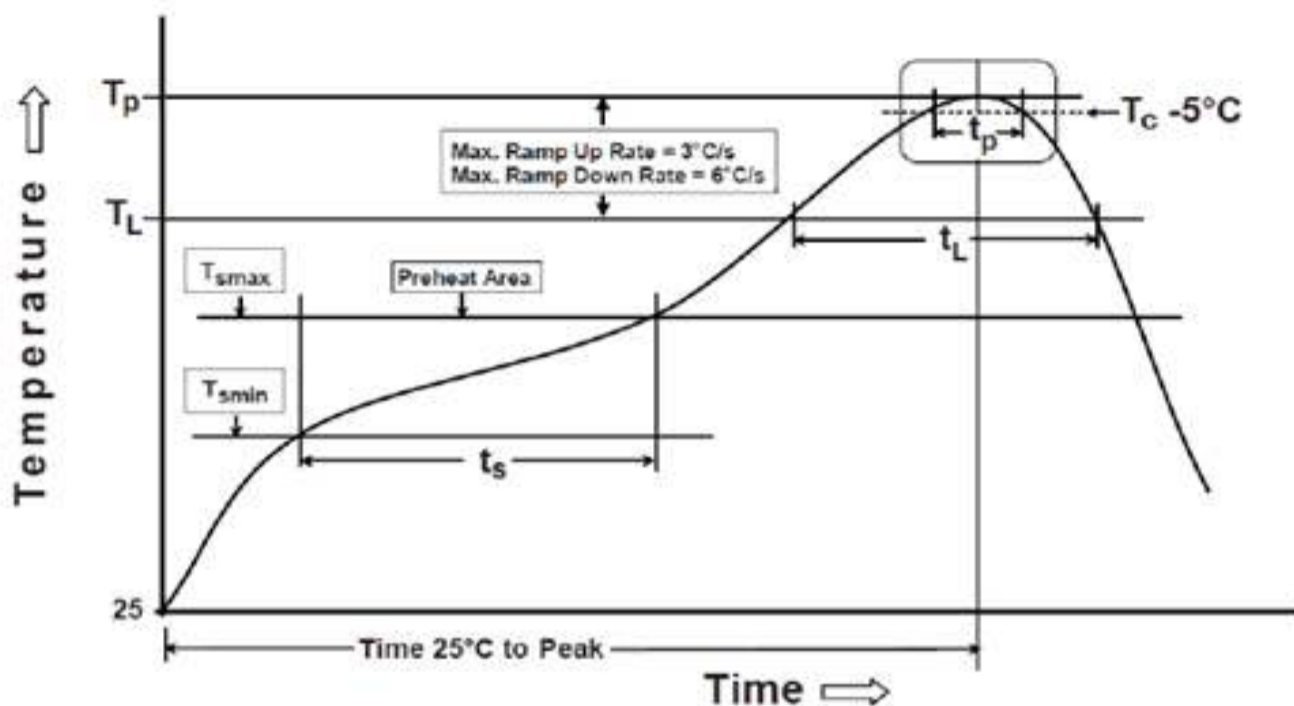

Phase	Profile Feature	Pb-Free Assembly (SnAgCu)
Preheat	-Temperature Min (T_{Smin})	150°C
	-Temperature Max (T_{Smax})	200°C
	-Time(ts) form (T_{Smin} to T_{Smax})	60-120 seconds
Ramp-Up	Avg. Ramp-up Rate (T_{Smax} to TP)	3°C/second(max)
Reflow	-Temperature (TL)	217°C
	-Total Time above TL (tL)	300-100 seconds
Peak	-Temperature(TP)	260°C
	-Time(tp)	5-10 seconds
Ramp-Down	Rate	6°C/second max.
Temperature at 25°C to Peak Temperature		8 minutes max.
Composition of Solder Paste		96.5Sn/3Ag/0.5Cu
Solder Paste Model		SHENMAO PF606-P26

NOTE:

If the temperature is over what is recommended, the component surface will peel or damage.

SOLDERING CONDITION:

Soldering iron temperature: 270±10 °C. Apply preheating at 120°C for 2-3 minutes. Finish soldering each terminal within 3 seconds. If the soldering iron is over 270±10 °C or 3 seconds, the component surface will peel or damage.

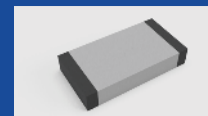

ACAR0301-SG3



3.05 x 1.6 x 0.55 mm
 RoHS/RoHS II Compliant
 MSL - N/A

Transmission Line and Matching

Typical config.1

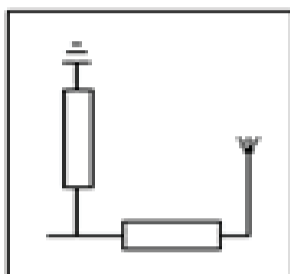

Typical config.2

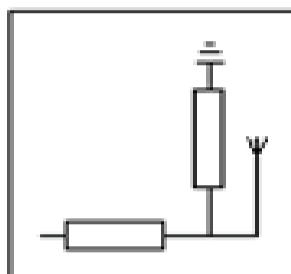

Component types

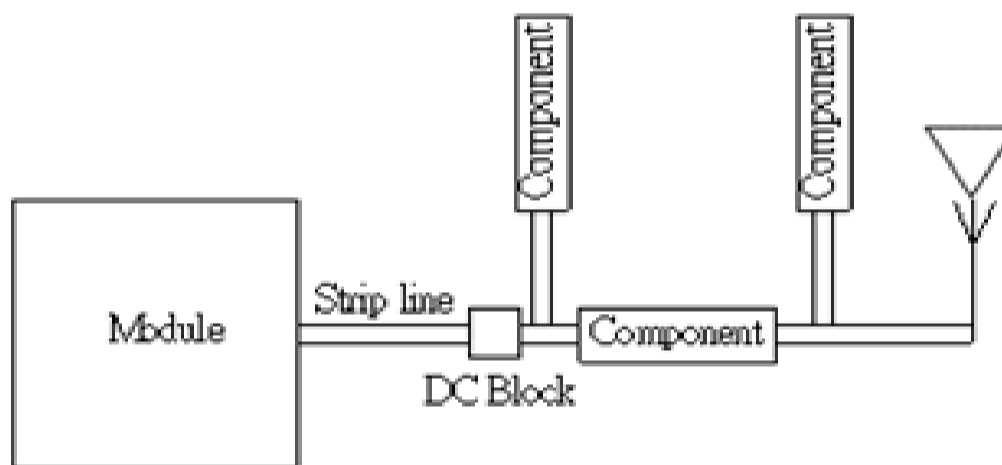
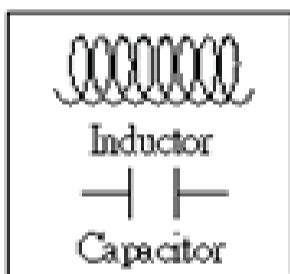

The matching network has to be individually designed using one,two or three components.

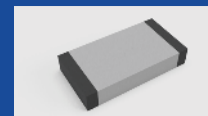

ACAR0301-SG3



3.05 x 1.6 x 0.55 mm
 RoHS/RoHS II Compliant
 MSL - N/A

Packaging

1. Quantity per reel: 5,000pcs
2. Dimensions of inner box: 350*350*47mm
3. Quantity per outer carton: 140,000pcs
4. Weight of outer carton: 5.5 KG

Tape Dimensions (mm)

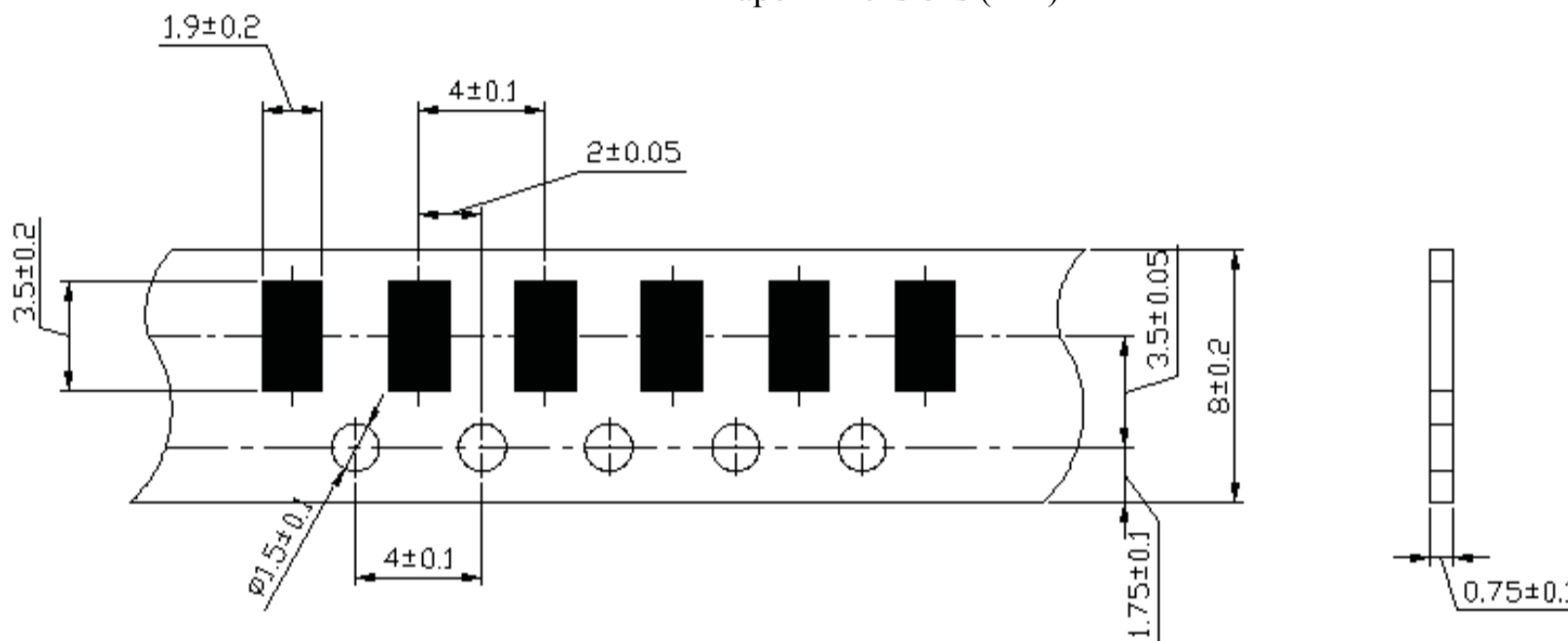

Reel Dimensions (mm)

