

**ISOTOP[®] Buck chopper
Trench + Field Stop IGBT4
Power module**

**$V_{CES} = 1200V$
 $I_C = 40A @ T_c = 80^{\circ}C$**

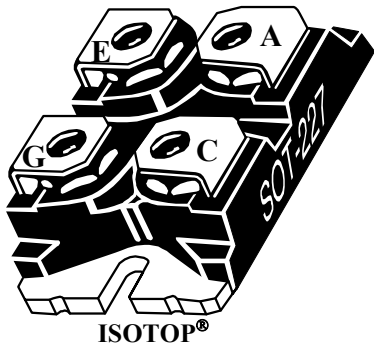
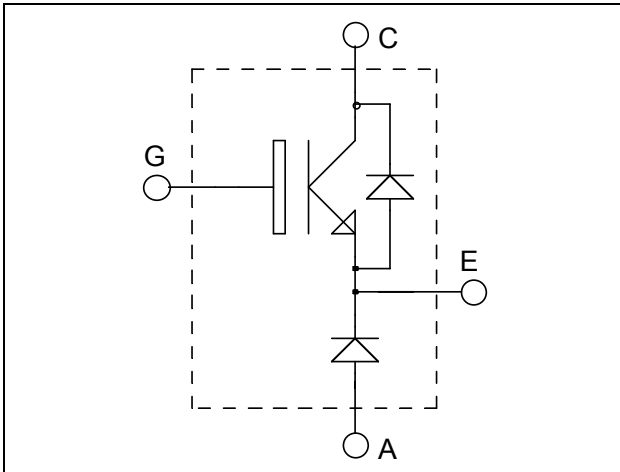

Application

- AC and DC motor control
- Switched Mode Power Supplies

Features

- Trench + Field Stop IGBT 4 Technology
 - Low voltage drop
 - Low leakage current
 - Low switching losses
 - Soft recovery parallel diodes
 - Low diode VF
 - Low leakage current
 - RBSOA and SCSOA rated
- ISOTOP[®] Package (SOT-227)
- Very low stray inductance
- High level of integration

Benefits

- Low conduction losses
- Stable temperature behavior
- Very rugged
- Direct mounting to heatsink (isolated package)
- Low junction to case thermal resistance
- Easy paralleling due to positive T_c of V_{CEsat}
- RoHS Compliant

Absolute maximum ratings

Symbol	Parameter		Max ratings	Unit
V_{CES}	Collector - Emitter Breakdown Voltage		1200	V
I_C	Continuous Collector Current	$T_c = 25^{\circ}C$	65	A
		$T_c = 80^{\circ}C$	40	
I_{CM}	Pulsed Collector Current	$T_c = 25^{\circ}C$	70	
V_{GE}	Gate - Emitter Voltage		± 20	V
P_D	Maximum Power Dissipation	$T_c = 25^{\circ}C$	220	W
RBSOA	Reverse Bias Safe Operating Area	$T_j = 150^{\circ}C$	70A @ 1100V	

CAUTION: These Devices are sensitive to Electrostatic Discharge. Proper Handling Procedures Should Be Followed. See application note APT0502 on www.microsemi.com

All ratings @ $T_j = 25^\circ\text{C}$ unless otherwise specified

Electrical Characteristics

Symbol	Characteristic	Test Conditions	Min	Typ	Max	Unit
I_{CES}	Zero Gate Voltage Collector Current	$V_{GE} = 0V, V_{CE} = 1200V$			250	μA
$V_{CE(sat)}$	Collector Emitter saturation Voltage	$V_{GE} = 15V$ $I_C = 35A$		1.85 2.25	2.25	V
		$T_j = 25^\circ\text{C}$ $T_j = 150^\circ\text{C}$				
$V_{GE(th)}$	Gate Threshold Voltage	$V_{GE} = V_{CE}, I_C = 1.2mA$	5.0	5.8	6.5	V
I_{GES}	Gate – Emitter Leakage Current	$V_{GE} = 20V, V_{CE} = 0V$			400	nA

Dynamic Characteristics

Symbol	Characteristic	Test Conditions	Min	Typ	Max	Unit
C_{ies}	Input Capacitance	$V_{GE} = 0V$		1950		pF
C_{oes}	Output Capacitance	$V_{CE} = 25V$		155		
C_{res}	Reverse Transfer Capacitance	$f = 1MHz$		115		
Q_G	Gate charge	$V_{GE} = \pm 15V; V_{CE} = 600V$ $I_C = 35A$		0.27		μC
$T_{d(on)}$	Turn-on Delay Time	Inductive Switching (25°C) $V_{GE} = \pm 15V$ $V_{CE} = 600V$ $I_C = 35A$ $R_G = 12\Omega$		130		ns
T_r	Rise Time			20		
$T_{d(off)}$	Turn-off Delay Time			300		
T_f	Fall Time			45		
$T_{d(on)}$	Turn-on Delay Time	Inductive Switching (150°C) $V_{GE} = \pm 15V$ $V_{CE} = 600V$ $I_C = 35A$ $R_G = 12\Omega$		150		ns
T_r	Rise Time			35		
$T_{d(off)}$	Turn-off Delay Time			350		
T_f	Fall Time			80		
E_{on}	Turn-on Switching Energy	$V_{GE} = \pm 15V$ $V_{CE} = 600V$ $I_C = 35A$ $R_G = 12\Omega$	$T_j = 25^\circ\text{C}$ $T_j = 150^\circ\text{C}$	2.6 4		mJ
E_{off}	Turn-off Switching Energy		$T_j = 25^\circ\text{C}$ $T_j = 150^\circ\text{C}$	2 3		mJ
I_{sc}	Short Circuit data	$V_{GE} \leq 15V; V_{Bus} = 900V$ $t_p \leq 10\mu\text{s}; T_j = 150^\circ\text{C}$		140		A

Chopper diode ratings and characteristics

Symbol	Characteristic	Test Conditions	Min	Typ	Max	Unit
V_{RRM}	Maximum Peak Repetitive Reverse Voltage		1200			V
I_{RM}	Maximum Reverse Leakage Current	$V_R = 1200V$			100 500	μA
		$T_j = 25^\circ\text{C}$ $T_j = 150^\circ\text{C}$				
I_F	DC Forward Current	$T_c = 80^\circ\text{C}$		30		A
V_F	Diode Forward Voltage	$I_F = 30A$ $I_F = 60A$ $I_F = 30A$		2.6 3.2 1.8	3.1	V
		$T_j = 125^\circ\text{C}$				
t_{rr}	Reverse Recovery Time	$I_F = 30A$ $V_R = 800V$ $di/dt = 200A/\mu\text{s}$	$T_j = 25^\circ\text{C}$ $T_j = 125^\circ\text{C}$	300 380		ns
Q_{rr}	Reverse Recovery Charge		$T_j = 25^\circ\text{C}$ $T_j = 125^\circ\text{C}$	360 1700		nC

Thermal and package characteristics

Symbol	Characteristic	Min	Typ	Max	Unit
R _{thJC}	Junction to Case Thermal Resistance	IGBT		0.68	°C/W
		Diode		1.2	
R _{thJA}	Junction to Ambient (IGBT & Diode)			20	
V _{ISOL}	RMS Isolation Voltage, any terminal to case t=1 min, 50/60Hz	2500			V
T _J , T _{STG}	Storage Temperature Range	-55		175	°C
T _L	Max Lead Temp for Soldering: 0.063" from case for 10 sec			300	
Torque	Mounting torque (Mounting = 8-32 or 4mm Machine and terminals = 4mm Machine)			1.5	N.m
Wt	Package Weight		29.2		g

SOT-227 (ISOTOP®) Package Outline

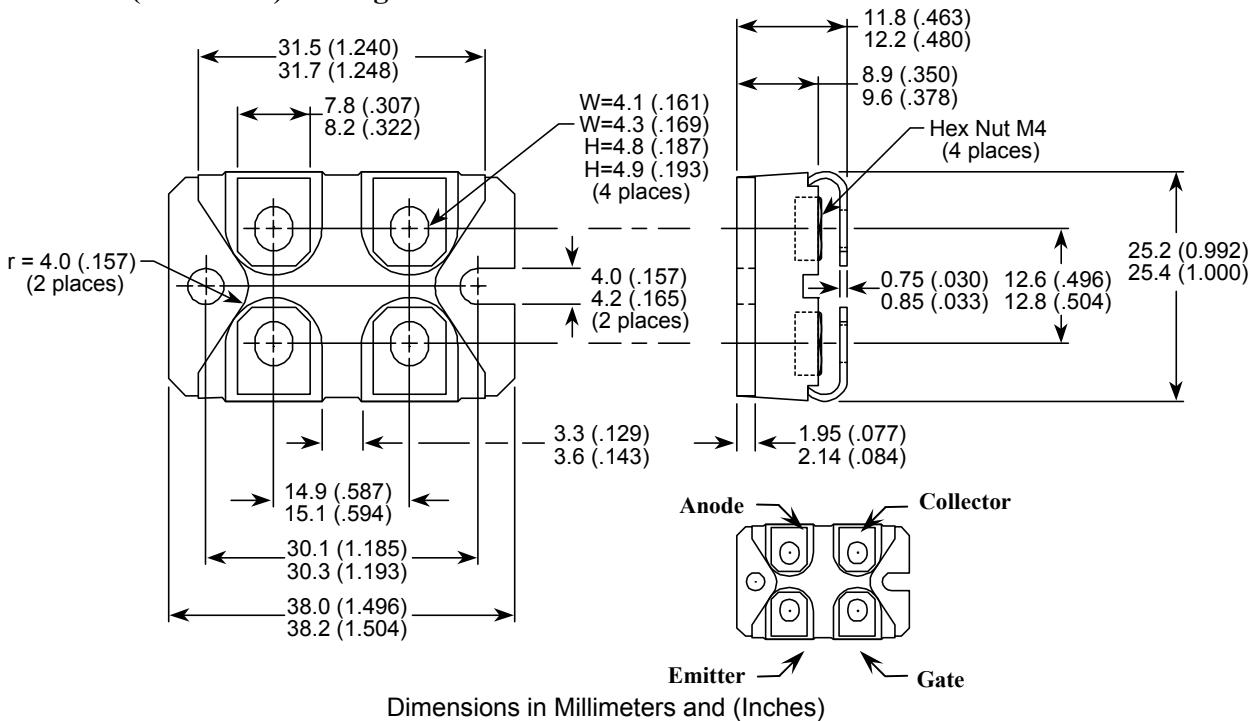

ISOTOP® is a registered trademark of ST Microelectronics NV

Typical Performance Curve

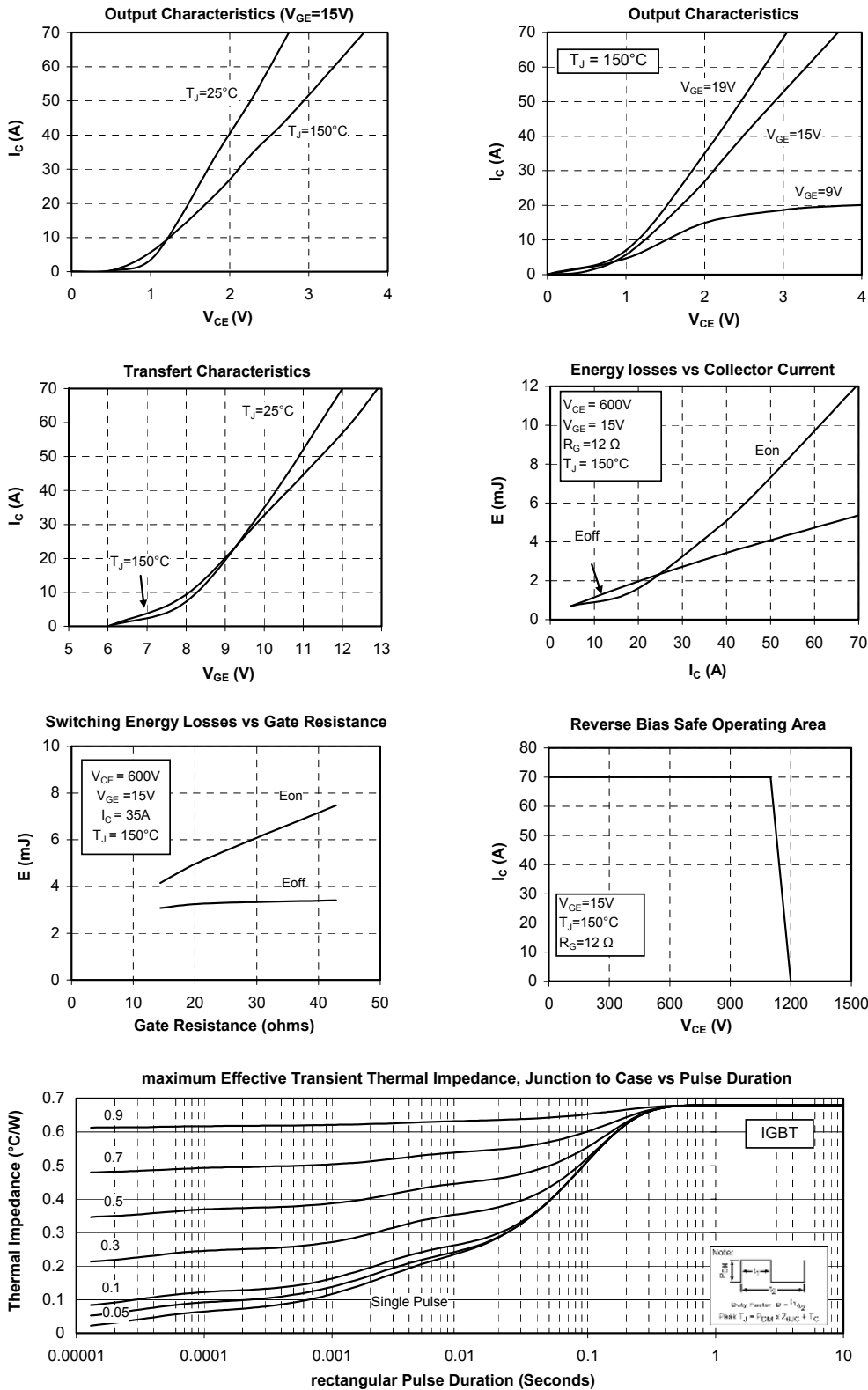

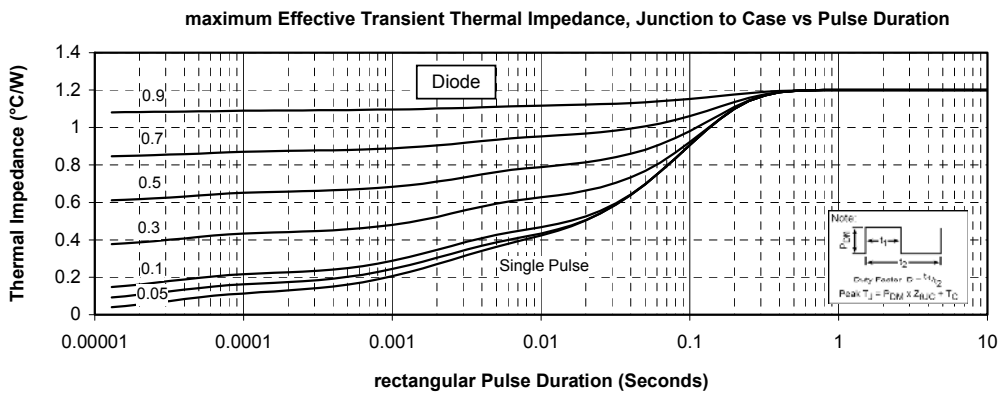
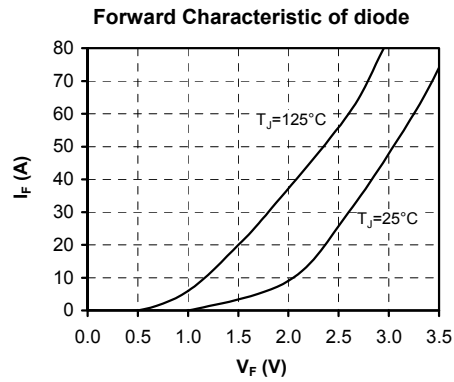
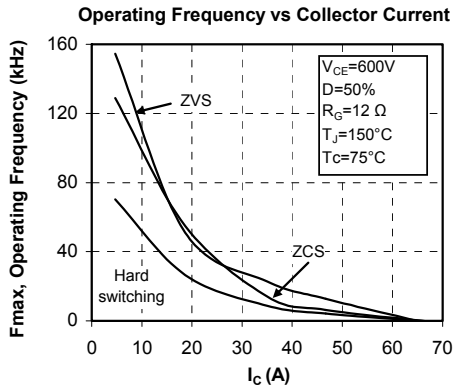

DISCLAIMER

The information contained in the document (unless it is publicly available on the Web without access restrictions) is PROPRIETARY AND CONFIDENTIAL information of Microsemi and cannot be copied, published, uploaded, posted, transmitted, distributed or disclosed or used without the express duly signed consent of Microsemi. If the recipient of this document has entered into a disclosure agreement with Microsemi, then the terms of such Agreement will also apply. This document and the information contained herein may not be modified, by any person other than authorized personnel of Microsemi. No license under any patent, copyright, trade secret or other intellectual property right is granted to or conferred upon you by disclosure or delivery of the information, either expressly, by implication, inducement, estoppels or otherwise. Any license under such intellectual property rights must be approved by Microsemi in writing signed by an officer of Microsemi.

Microsemi reserves the right to change the configuration, functionality and performance of its products at anytime without any notice. This product has been subject to limited testing and should not be used in conjunction with life-support or other mission-critical equipment or applications. Microsemi assumes no liability whatsoever, and Microsemi disclaims any express or implied warranty, relating to sale and/or use of Microsemi products including liability or warranties relating to fitness for a particular purpose, merchantability, or infringement of any patent, copyright or other intellectual property right. Any performance specifications believed to be reliable but are not verified and customer or user must conduct and complete all performance and other testing of this product as well as any user or customers final application. User or customer shall not rely on any data and performance specifications or parameters provided by Microsemi. It is the customer's and user's responsibility to independently determine suitability of any Microsemi product and to test and verify the same. The information contained herein is provided "AS IS, WHERE IS" and with all faults, and the entire risk associated with such information is entirely with the User. Microsemi specifically disclaims any liability of any kind including for consequential, incidental and punitive damages as well as lost profit. The product is subject to other terms and conditions which can be located on the web at <http://www.microsemi.com/legal/tnc.asp>

Life Support Application

Seller's Products are not designed, intended, or authorized for use as components in systems intended for space, aviation, surgical implant into the body, in other applications intended to support or sustain life, or for any other application in which the failure of the Seller's Product could create a situation where personal injury, death or property damage or loss may occur (collectively "Life Support Applications").

Buyer agrees not to use Products in any Life Support Applications and to the extent it does it shall conduct extensive testing of the Product in such applications and further agrees to indemnify and hold Seller, and its officers, employees, subsidiaries, affiliates, agents, sales representatives and distributors harmless against all claims, costs, damages and expenses, and attorneys' fees and costs arising, directly or indirectly, out of any claims of personal injury, death, damage or otherwise associated with the use of the goods in Life Support Applications, even if such claim includes allegations that Seller was negligent regarding the design or manufacture of the goods.

Buyer must notify Seller in writing before using Seller's Products in Life Support Applications. Seller will study with Buyer alternative solutions to meet Buyer application specification based on Sellers sales conditions applicable for the new proposed specific part.