

15V PNP MEDIUM POWER HIGH GAIN TRANSISTOR IN SOT223
Features

- $BV_{CEO} > -15V$
- $BV_{CBO} > -15V$
- $I_C = -3A$ High Continuous Current
- $h_{FE} > 300$ @ $-2A$ and Low Saturation Voltage
- Extremely Low Equivalent On-Resistance $R_{CE(sat)}$ 93mΩ at $-3A$
- Complementary NPN Type: DIODES™ FZT688B
- **Lead-Free Finish; RoHS Compliant (Notes 1 & 2)**
- **Halogen and Antimony Free. "Green" Device (Note 3)**
- **For automotive applications requiring specific change control (i.e. parts qualified to AEC-Q100/101/200, PPAP capable, and manufactured in IATF 16949 certified facilities), please [contact us](mailto:contact@diodes.com) or your local Diodes representative. <https://www.diodes.com/quality/product-definitions/>**

Mechanical Data

- Package: SOT223
- Package Material: Molded Plastic, "Green" Molding Compound; UL Flammability Rating 94V-0
- Moisture Sensitivity: Level 1 per J-STD-020
- Terminals: Finish - Matte Tin Plated Leads; Solderable per MIL-STD-202, Method 208 (e3)
- Weight: 0.112 grams (Approximate)

Applications

- Flash Gun Convertors
- Battery Powered Circuits



SOT223

Top View

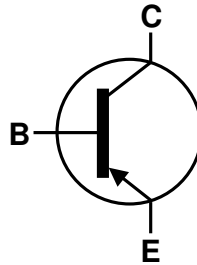

Device Symbol

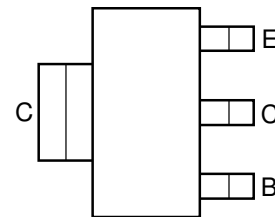
 Top View
Pin-Out

Ordering Information (Note 4)

Product	Compliance	Marking	Reel size (inches)	Tape width (mm)	Quantity per reel
FZT788BTA	Standard	FZT788B	7	12	1,000
FZT788BTC	Standard	FZT788B	13	12	2,500

- Notes:
1. EU Directive 2002/95/EC (RoHS), 2011/65/EU (RoHS 2) & 2015/863/EU (RoHS 3) compliant. All applicable RoHS exemptions applied.
 2. See <https://www.diodes.com/quality/lead-free/> for more information about Diodes Incorporated's definitions of Halogen- and Antimony-free, "Green" and Lead-free.
 3. Halogen- and Antimony-free "Green" products are defined as those which contain <900ppm bromine, <900ppm chlorine (<1500ppm total Br + Cl) and <1000ppm antimony compounds.
 4. For packaging details, go to our website at <https://www.diodes.com/design/support/packaging/diodes-packaging/>.

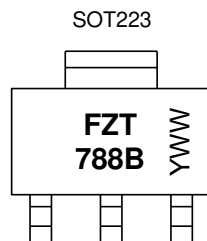
Marking Information

SOT223

FZT 788B = Product Type Marking Code
 YWW = Date Code Marking
 Y or \bar{Y} = Last Digit of Year (ex: 5= 2015)
 WW or $\bar{W}W$ = Week Code (01~53)

Absolute Maximum Ratings (@T_A = +25°C, unless otherwise specified.)

Characteristic	Symbol	Value	Unit
Collector-Base Voltage	V _{CBO}	-15	V
Collector-Emitter Voltage	V _{CEO}	-15	V
Emitter-Base Voltage	V _{EBO}	-7	V
Continuous Collector Current	I _C	-3	A
Peak Pulse Current	I _{CM}	-8	A

Thermal Characteristics (@T_A = +25°C, unless otherwise specified.)

Characteristic	Symbol	Value	Unit	
Power Dissipation	P _D	(Note 5)	3	W
		(Note 6)	2	
		(Note 7)	1.6	
		(Note 8)	1.2	
Thermal Resistance, Junction to Ambient	R _{θJA}	(Note 5)	41.7	°C/W
		(Note 6)	62.5	
		(Note 7)	78.1	
		(Note 8)	104	
Thermal Resistance Junction to Lead	R _{θJL}	12.9		
Operating and Storage Temperature Range	T _J , T _{STG}	-55 to +150	°C	

ESD Ratings (Note 10)

Characteristic	Symbol	Value	Unit	JEDEC Class
Electrostatic Discharge - Human Body Model	ESD HBM	4,000	V	3A
Electrostatic Discharge - Machine Model	ESD MM	400	V	C

- Notes:
5. For a device mounted with the collector lead on 50mm x 50mm 2oz copper that is on a single-sided 1.6mm FR4 PCB; device is measured under still air conditions whilst operating in a steady-state.
 6. Same as Note 5, except the device is mounted on 25mm x 25mm 2oz copper.
 7. Same as Note 5, except the device is mounted on 25mm x 25mm 1oz copper.
 8. Same as Note 5, except the device is mounted on minimum recommended pad layout.
 9. Thermal resistance from junction to solder-point (at the end of the collector lead).
 10. Refer to JEDEC specification JESD22-A114 and JESD22-A115.

Thermal Characteristics and Derating Information

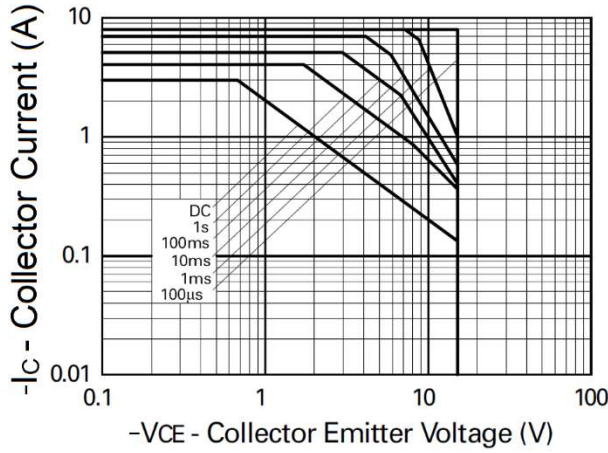

Safe Operating Area

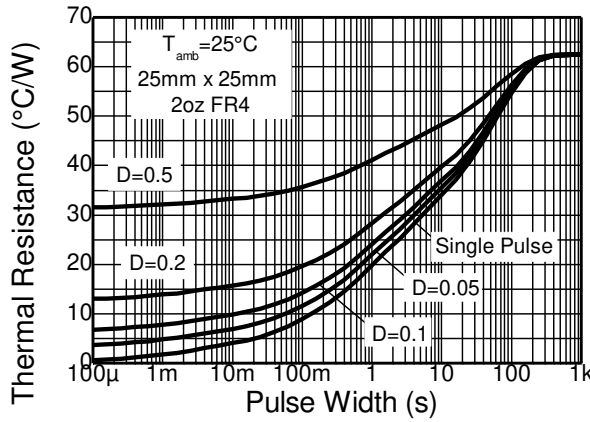

Transient Thermal Impedance

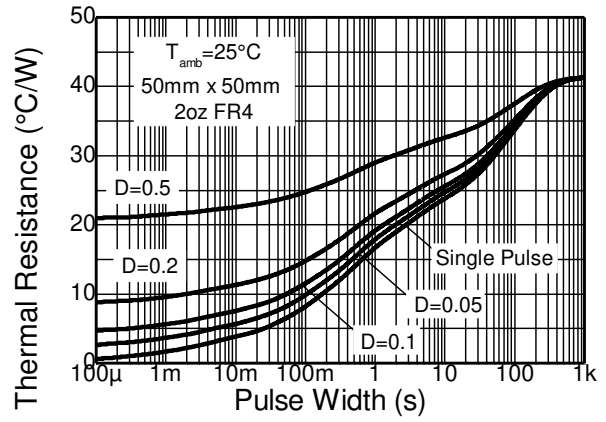

Transient Thermal Impedance

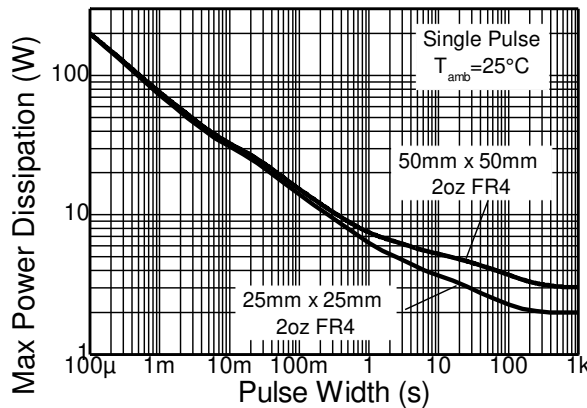

Pulse Power Dissipation

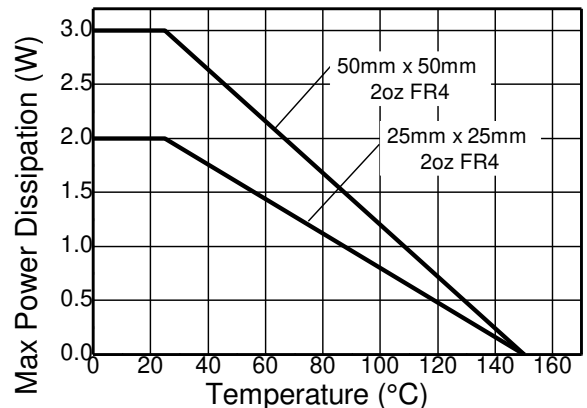

Derating Curve

Electrical Characteristics (@T_A = +25°C, unless otherwise specified.)

Characteristic	Symbol	Min	Typ	Max	Unit	Test Condition
Collector-Base Breakdown Voltage	BV_{CBO}	-15	—	—	V	$I_C = -100\mu A$
Collector-Emitter Breakdown Voltage (Note 11)	BV_{CEO}	-15	—	—	V	$I_C = -10mA$
Emitter-Base Breakdown Voltage	BV_{EBO}	-7	—	—	V	$I_E = -100\mu A$
Collector-Base Cut-Off Current	I_{CBO}	—	—	-100	nA	$V_{CB} = -10V$
Emitter Cut-Off Current	I_{EBO}	—	—	-100	nA	$V_{EB} = -4V$
DC Current Gain (Note 11)	h_{FE}	500 400 300 150	— — — —	— — — —	—	$I_C = -10mA, V_{CE} = -2V$ $I_C = -1A, V_{CE} = -2V$ $I_C = -2A, V_{CE} = -2V$ $I_C = -6A, V_{CE} = -2V$
Collector-Emitter Saturation Voltage (Note 11)	$V_{CE(sat)}$	— — — —	— — — —	-0.15 -0.25 -0.45 -0.5	V	$I_C = -0.5A, I_B = -2.5mA$ $I_C = -1A, I_B = -5mA$ $I_C = -2A, I_B = -10mA$ $I_C = -3A, I_B = -50mA$
Base-Emitter Saturation Voltage (Note 11)	$V_{BE(sat)}$	—	—	-0.9	V	$I_C = -1A, I_B = -5mA$
Base-Emitter Turn-On Voltage (Note 11)	$V_{BE(on)}$	—	-0.75	—	V	$I_C = -1A, V_{CE} = -2V$
Input Capacitance	C_{ibo}	—	225	—	pF	$V_{EB} = -0.5V, f = 1MHz$
Output Capacitance	C_{obo}	—	25	—	pF	$V_{CB} = -10V, f = 1MHz$
Current Gain-Bandwidth Product	f_T	100	—	—	MHz	$V_{CE} = -5V, I_C = -50mA, f = 50MHz$
Turn-On Time	t_{on}	—	35	—	ns	$V_{CC} = -10V, I_C = -500mA$
Turn-Off Time	t_{off}	—	400	—	ns	$I_{B1} = -I_{B2} = -50mA$

Note: 11. Measured under pulsed conditions. Pulse width $\leq 300 \mu s$. Duty cycle $\leq 2\%$.

Typical Electrical Characteristics (@ $T_A = +25^\circ\text{C}$, unless otherwise specified.)

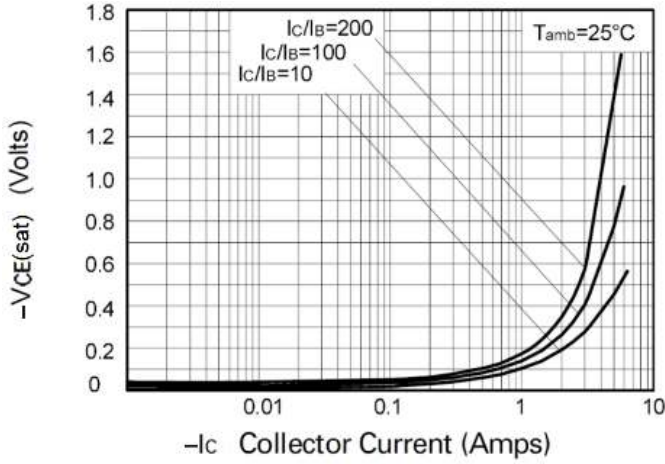

$V_{CE(sat)}$ v I_C

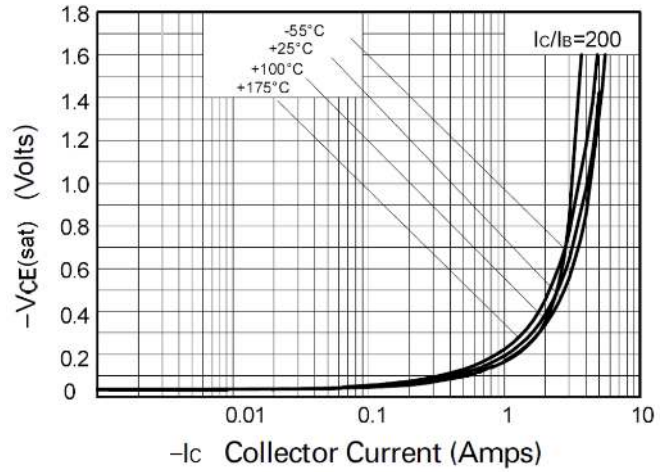

$V_{CE(sat)}$ v I_C

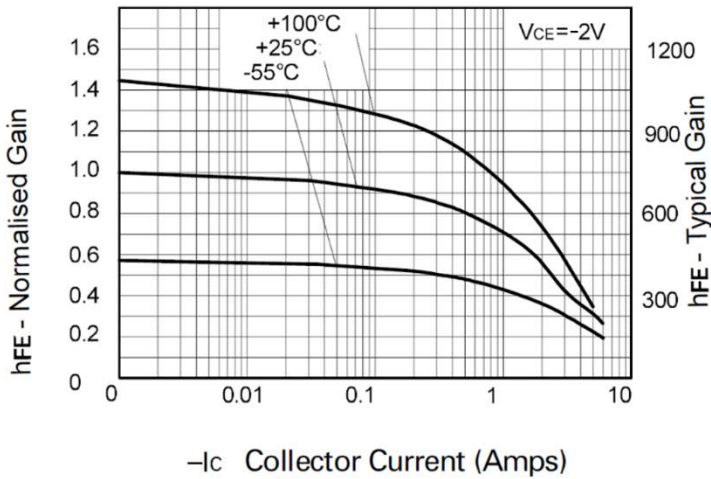

h_{FE} v I_C

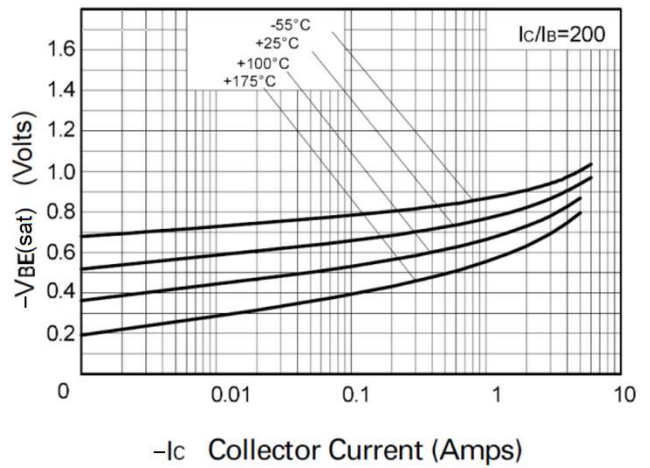

$V_{BE(sat)}$ v I_C

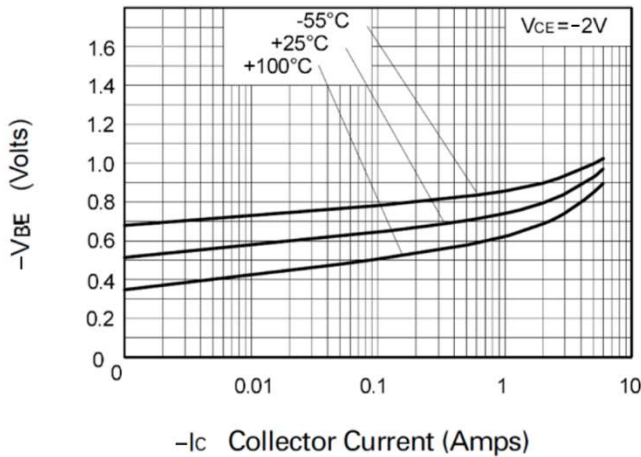

$V_{BE(on)}$ v I_C

Package Outline Dimensions

Please see <http://www.diodes.com/package-outlines.html> for the latest version.

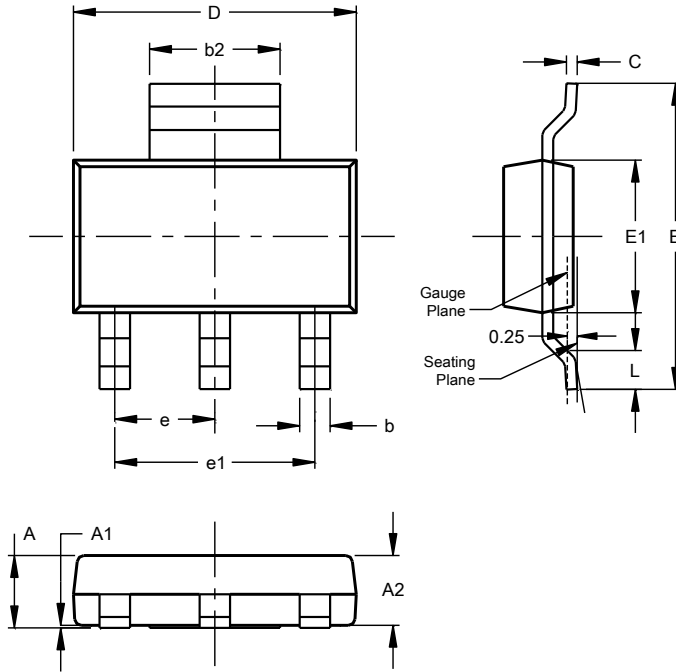

SOT223 (Type DN)			
Dim	Min	Max	Typ
A	--	1.70	--
A1	0.01	0.15	--
A2	1.50	1.68	1.60
b	0.60	0.80	0.70
b2	2.90	3.10	--
c	0.20	0.32	--
D	6.30	6.70	--
E	6.70	7.30	--
E1	3.30	3.70	--
e	--	--	2.30
e1	--	--	4.60
L	0.85	--	--
All Dimensions in mm			

Suggested Pad Layout

Please see <http://www.diodes.com/package-outlines.html> for the latest version.

SOT223 (Type DN)

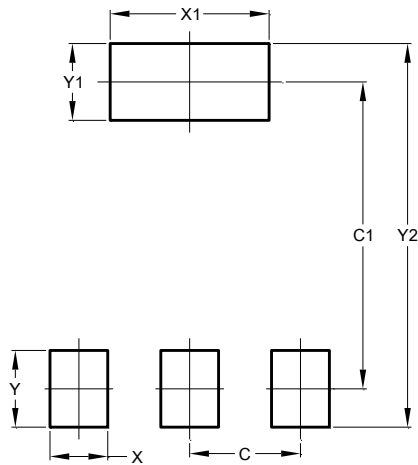

Dimensions	Value (in mm)
C	2.30
C1	6.40
X	1.20
X1	3.30
Y	1.60
Y1	1.60
Y2	8.00

IMPORTANT NOTICE

1. DIODES INCORPORATED AND ITS SUBSIDIARIES (“DIODES”) MAKE NO WARRANTY OF ANY KIND, EXPRESS OR IMPLIED, WITH REGARDS TO ANY INFORMATION CONTAINED IN THIS DOCUMENT, INCLUDING, BUT NOT LIMITED TO, THE IMPLIED WARRANTIES OF MERCHANTABILITY, FITNESS FOR A PARTICULAR PURPOSE OR NON-INFRINGEMENT OF THIRD PARTY INTELLECTUAL PROPERTY RIGHTS (AND THEIR EQUIVALENTS UNDER THE LAWS OF ANY JURISDICTION).
2. The Information contained herein is for informational purpose only and is provided only to illustrate the operation of Diodes products described herein and application examples. Diodes does not assume any liability arising out of the application or use of this document or any product described herein. This document is intended for skilled and technically trained engineering customers and users who design with Diodes products. Diodes products may be used to facilitate safety-related applications; however, in all instances customers and users are responsible for (a) selecting the appropriate Diodes products for their applications, (b) evaluating the suitability of the Diodes products for their intended applications, (c) ensuring their applications, which incorporate Diodes products, comply the applicable legal and regulatory requirements as well as safety and functional-safety related standards, and (d) ensuring they design with appropriate safeguards (including testing, validation, quality control techniques, redundancy, malfunction prevention, and appropriate treatment for aging degradation) to minimize the risks associated with their applications.
3. Diodes assumes no liability for any application-related information, support, assistance or feedback that may be provided by Diodes from time to time. Any customer or user of this document or products described herein will assume all risks and liabilities associated with such use, and will hold Diodes and all companies whose products are represented herein or on Diodes’ websites, harmless against all damages and liabilities.
4. Products described herein may be covered by one or more United States, international or foreign patents and pending patent applications. Product names and markings noted herein may also be covered by one or more United States, international or foreign trademarks and trademark applications. Diodes does not convey any license under any of its intellectual property rights or the rights of any third parties (including third parties whose products and services may be described in this document or on Diodes’ website) under this document.
5. Diodes products are provided subject to Diodes’ Standard Terms and Conditions of Sale (<https://www.diodes.com/about/company/terms-and-conditions/terms-and-conditions-of-sales/>) or other applicable terms. This document does not alter or expand the applicable warranties provided by Diodes. Diodes does not warrant or accept any liability whatsoever in respect of any products purchased through unauthorized sales channel.
6. Diodes products and technology may not be used for or incorporated into any products or systems whose manufacture, use or sale is prohibited under any applicable laws and regulations. Should customers or users use Diodes products in contravention of any applicable laws or regulations, or for any unintended or unauthorized application, customers and users will (a) be solely responsible for any damages, losses or penalties arising in connection therewith or as a result thereof, and (b) indemnify and hold Diodes and its representatives and agents harmless against any and all claims, damages, expenses, and attorney fees arising out of, directly or indirectly, any claim relating to any noncompliance with the applicable laws and regulations, as well as any unintended or unauthorized application.
7. While efforts have been made to ensure the information contained in this document is accurate, complete and current, it may contain technical inaccuracies, omissions and typographical errors. Diodes does not warrant that information contained in this document is error-free and Diodes is under no obligation to update or otherwise correct this information. Notwithstanding the foregoing, Diodes reserves the right to make modifications, enhancements, improvements, corrections or other changes without further notice to this document and any product described herein. This document is written in English but may be translated into multiple languages for reference. Only the English version of this document is the final and determinative format released by Diodes.
8. Any unauthorized copying, modification, distribution, transmission, display or other use of this document (or any portion hereof) is prohibited. Diodes assumes no responsibility for any losses incurred by the customers or users or any third parties arising from any such unauthorized use.

Copyright © 2022 Diodes Incorporated

www.diodes.com