

LTM4626  
20V<sub>IN</sub>, 12A Step-Down  
μModule Regulator

**DESCRIPTION**

Demonstration circuit 2665B-A features the LTM<sup>®</sup>4626 μModule<sup>®</sup> regulator, a high performance, high efficiency step-down regulator. The LTM4626 is a complete DC/DC point-of-load regulator in a thermally enhanced 6.25mm × 6.25mm × 3.87mm BGA package. The LTM4626 has an operating input voltage range of 3.1V to 20V and provides an output current up to 12A. The output voltage is programmable from 0.6V to 5.5V and can be remotely sensed. The stacked inductor design improves thermal dissipation and significantly reduces the package area. Output voltage tracking is available through the TRACK/SS pin for

supply rail sequencing. External clock synchronization is available through the SYNC/MODE pin. For high efficiency at low load currents, select discontinuous current mode (DCM) operation using the MODE jumper (JP7) in less noise sensitive applications. Refer to the LTM4626 data sheet in conjunction with this demo manual for working on or modifying the DC2665B-A.

**Design files for this circuit board are available.**

All registered trademarks and trademarks are the property of their respective owners.

**BOARD PHOTO** Part marking is either ink mark or laser mark

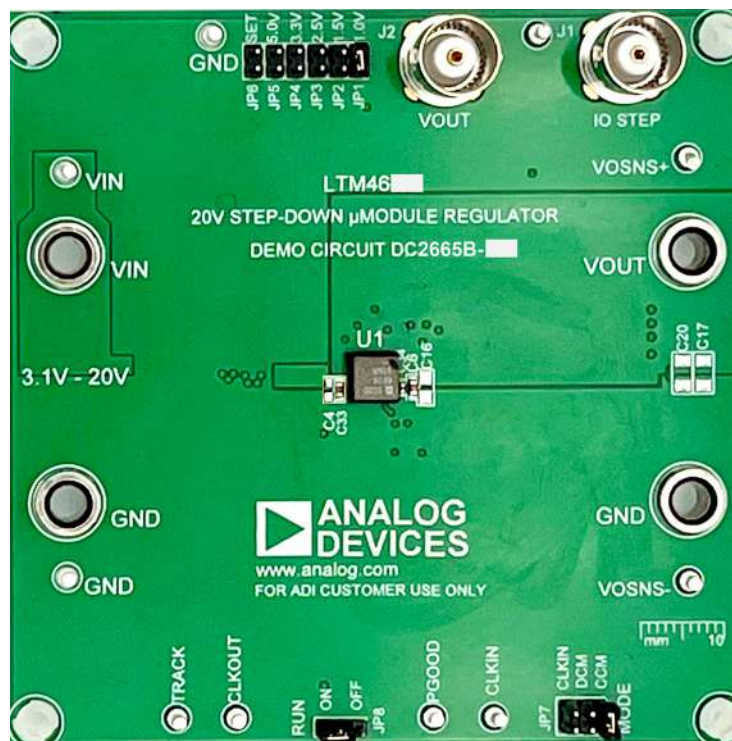

# DEMO MANUAL DC2665B-A

## PERFORMANCE SUMMARY Specifications are at $T_A = 25^\circ\text{C}$

PARAMETER	CONDITIONS	MIN	TYP	MAX	UNITS
Input Voltage Range		3.1		20	V
Output Voltage, $V_{OUT}$	Jumper Selection on JP1	0.98	1.0	1.02	V
	Jumper Selection on JP2	1.47	1.5	1.53	V
	Jumper Selection on JP3	2.45	2.5	2.55	V
	Jumper Selection on JP4	3.23	3.3	3.37	V
	Jumper Selection on JP5	4.9	5.0	5.1	V
Maximum Continuous Output Current	Derating Is Necessary for Certain Operating Conditions (See Data Sheet for Details)		12		A
Default Operating Frequency			600		kHz
Efficiency	$V_{IN} = 12\text{V}$ , $V_{OUT} = 1\text{V}$ , $I_{OUT} = 12\text{A}$		85		%

## QUICK START PROCEDURE

Demonstration circuit 2665B-A is an easy way to evaluate the performance of the LTM4626EY. Refer to Figure 1 for test setup connections and use the following procedure.

1. With power off, place the jumpers in the following positions:

JP8	JP7	JP1 TO JP6
RUN	MODE	$V_{OUT}$ Select
ON	CCM	1V

2. Before connecting the input supply, load, and meters, preset the input voltage supply between 3.1V and 20V. Preset the load current to 0A.

3. With the power off, connect the load, input voltage supply, and meters as shown in Figure 1.

4. Turn on the input power supply. The output voltage meters for each phase display the  $\pm 1.2\%$  programmed output voltage .

5. Once the proper output voltage is established, adjust the load current in the 0A to 12A range and observe the load regulation, efficiency, and other parameters. Measure the output voltage ripple across the furthest output cap with a BNC cable and oscilloscope from J2.

6. Place the MODE pin jumper (JP7) in the DCM position to observe increased light load efficiency.

7. For optional load transient testing, an onboard transient circuit is provided to measure transient response. Place a positive pulse signal between the IO\_STEP\_CLK (E10) pin and GND pin. The pulse amplitude sets the load step current amplitude. Keep the pulse width short ( $<1\text{ms}$ ) and the pulse duty cycle low ( $<15\%$ ) to limit the thermal stress on the load transient circuit. Monitor the load step with a BNC connected to J1 (5mV/A).

## QUICK START PROCEDURE

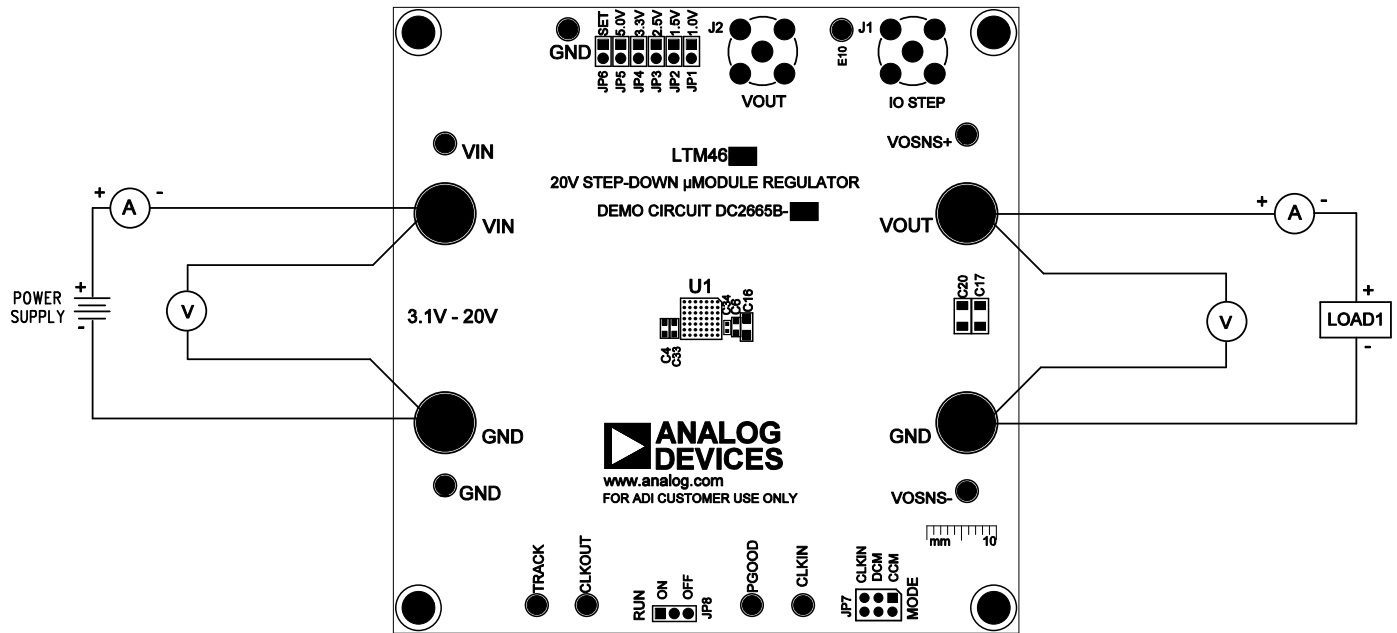

Figure 1. Test Setup of DC2665B-A

### NOTES:

1. To achieve the minimum output ripple voltage, optimize the operation frequency at different input and output voltages. Suggested operation frequencies at different voltages are shown in Table 1. Adjust the operation frequency by changing the value of  $R_{fSET}$  (R5). Refer to the LTM4626 data sheet for a detailed calculation of  $R_{fSET}$  (R5).

Table 1. Suggested Operation Frequencies

	3.3V <sub>IN</sub>					5V <sub>IN</sub>						12V <sub>IN</sub>							
V <sub>OUT</sub> (V)	1	1.2	1.5	1.8	2.5	1	1.2	1.5	1.8	2.5	3.3	1	1.2	1.5	1.8	2.5	3.3	5	
f <sub>sw</sub> (kHz)	600	600	600	600	600	600	600	800	800	1000	1000	600	800	800	1000	1500	1500	2000	

2. For applications that require small output voltage ripple, add shunt-through three-terminal capacitors on the output at C41 and C42.

**QUICK START PROCEDURE**

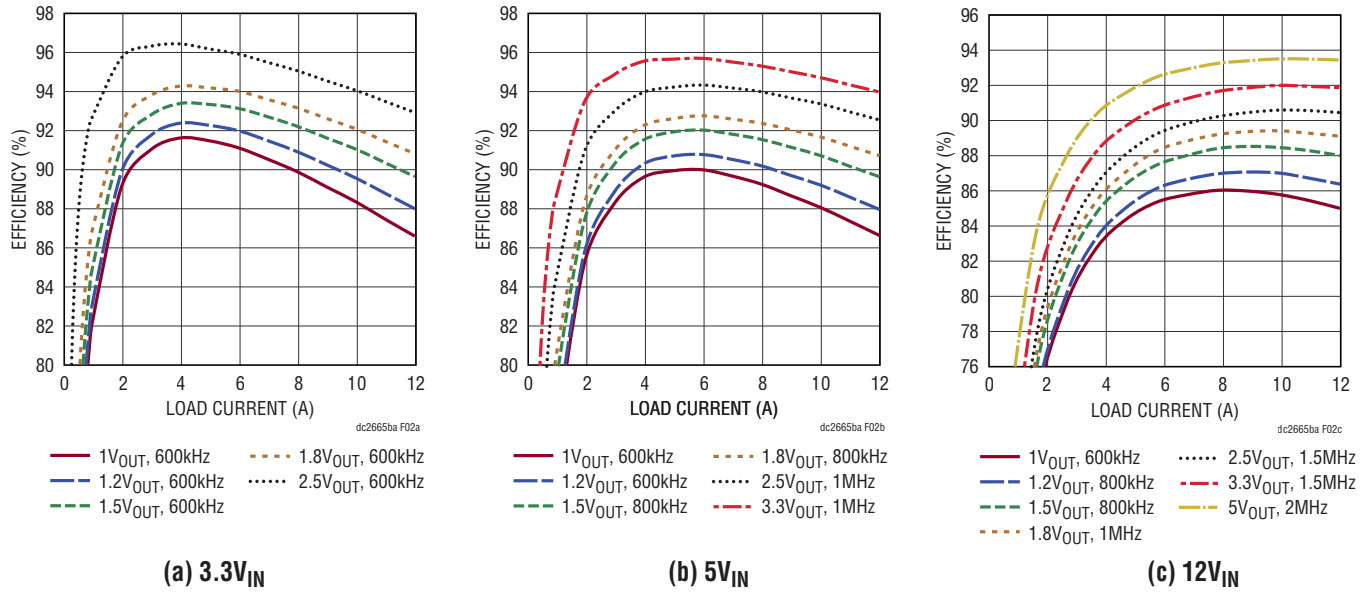

Figure 2. Measured Supply, CCM Efficiency vs Load Current

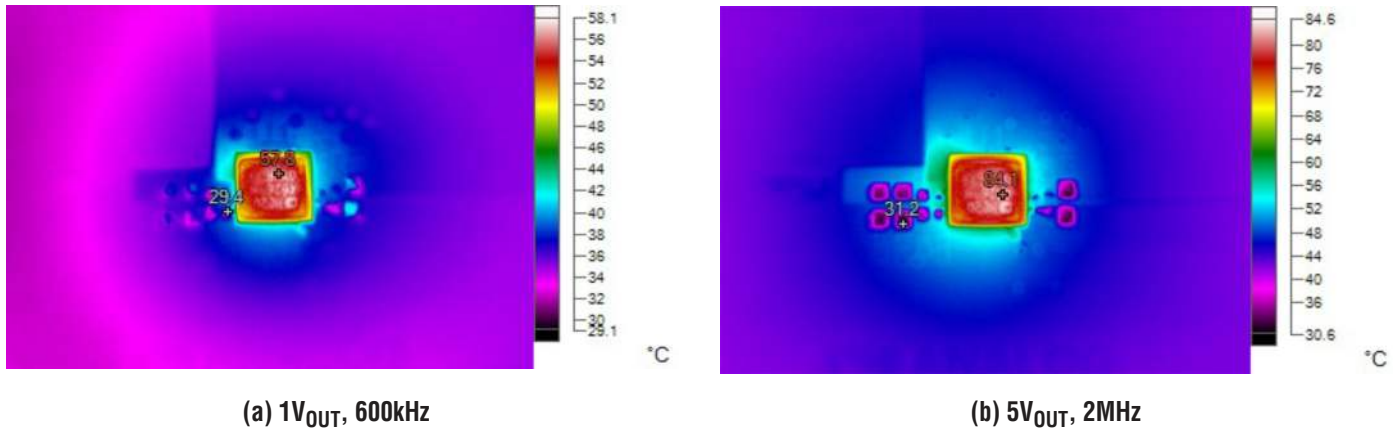
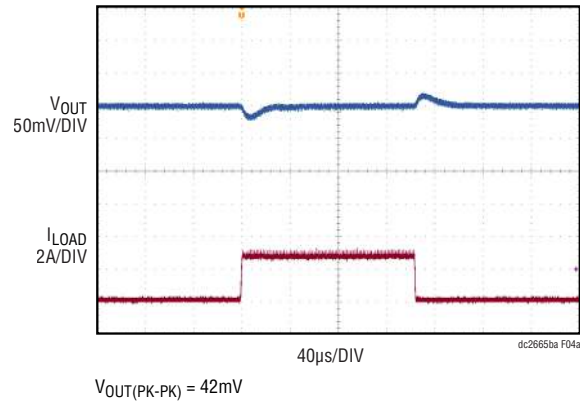
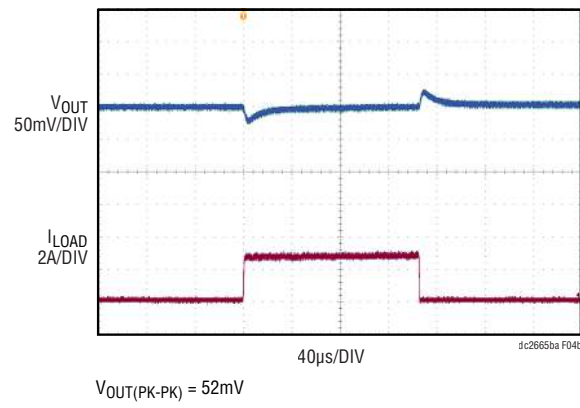

Figure 3. Measured Thermal Capture at 12V<sub>IN</sub>, I<sub>OUT</sub> = 12A at 25°C Ambient with No Airflow

**QUICK START PROCEDURE**



**(a) 1V<sub>OUT</sub>**



**(b) 5V<sub>OUT</sub>**

**Figure 4. Load Transient (6A to 9A) Response Waveform at 12V<sub>IN</sub>**

## QUICK START PROCEDURE

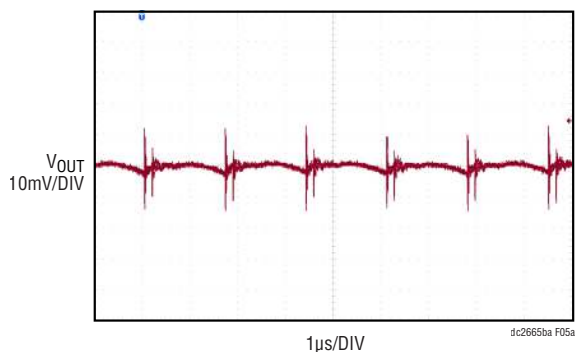

$V_{OUT(PK-PK)} = 27.6mV$

**(a) 1V<sub>OUT</sub>, 600kHz, Full Bandwidth (500MHz)**

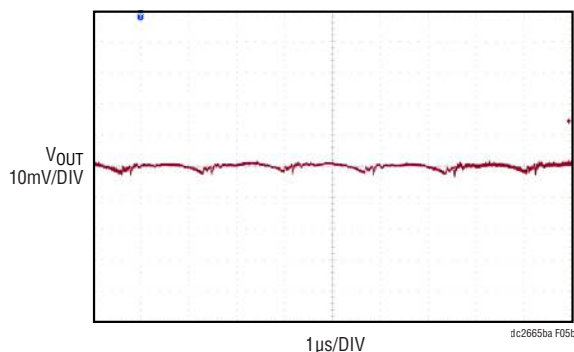

$V_{OUT(PK-PK)} = 4.8mV$

**(b) 1V<sub>OUT</sub>, 600kHz, 20MHz Bandwidth**

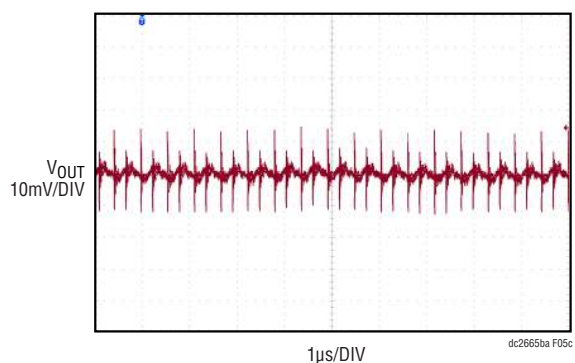

$V_{OUT(PK-PK)} = 27.6mV$

**(c) 5V<sub>OUT</sub>, 2MHz, Full Bandwidth (500MHz)**

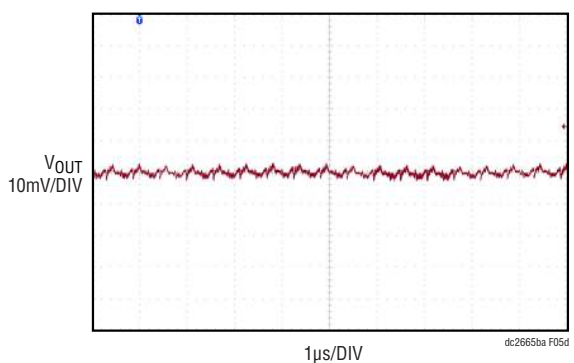

$V_{OUT(PK-PK)} = 5.6mV$

**(d) 5V<sub>OUT</sub>, 2MHz, 20MHz Bandwidth**

**Figure 5. Tested  $V_{OUT}$  AC Ripple at  $12V_{IN}$ ,  $I_{OUT} = 12A$ ,  $V_{OUT}$  Ripple Is Tested Across C12**

## PARTS LIST

ITEM	QTY	REFERENCE	PART DESCRIPTION	MANUFACTURER/PART NUMBER
<b>Required Circuit Components</b>				
1	3	C1, C6, C31	CAP, 2.2µF, X7R, 10V, 20%, 0603	TDK, C1608X7R1A225M080AC
2	3	C2, C3, C38	CAP, 22µF, X5R, 25V, 10%, 1206	AVX, 12063D226KAT2A
3	1	C33	CAP, 1µF, X7R, 25V, 10%, 0603	TDK, C1608X7R1E105K080AB
4	4	C5, C11, C12, C30	CAP, 220µF, X5R, 6.3V, 20%, 1206	MURATA, GRM31CR60J227ME11L
5	1	C7	CAP, 0.1µF, X7R, 25V, 10%, 0603	AVX, 06033C104KAT2A
6	1	C8	CAP, 100pF, X7R, 25V, 5%, 0603	AVX, 06033C101JAT2A
7	1	C10	CAP, 220µF, ALUM HYB, 35V, 20%	SUN ELECTRONIC, 35HVH220M

## PARTS LIST

ITEM	QTY	REFERENCE	PART DESCRIPTION	MANUFACTURER/PART NUMBER
8	1	C18	CAP, 1 $\mu$ F, X7R, 10V, 20%, 0603	AVX, 0603ZC105MAT2A
9	1	C29	CAP, 0.022 $\mu$ F, X7R, 50V, 10%, 0603	KEMET, C0603C223K5RAC7867
10	1	C34	CAP, 1 $\mu$ F, X7R, 6.3V, 10%, 0402	MURATA, GRM155R70J105KA12D
11	1	R3	RES., 10k, 1%, 1/10W, 0603	VISHAY, CRCW060310K0FKEAC
12	1	R4	RES., 90.9k, 0.5%, 1/10W, 0603	SUSUMU, RG1608P-9092-D-T5
13	1	R6	RES., 40.2k, 0.5%, 1/10W, 0603	SUSUMU, RG1608P-4022-D-T5
14	1	R14	RES., 13.3k, 0.5%, 1/10W, 0603	SUSUMU, RG1608P-1332-D-T5
15	1	R15	RES., 19.1k, 0.5%, 1/10W, 0603	SUSUMU, RG1608P-1912-D-T5
16	1	R24	RES., 8.25k, 0.5% 1/10W 0603	SUSUMU, RG1608P-8251-D-T5
17	2	R8, R16	RES., 100k, 1%, 1/10W, 0603	STACKPOLE ELECTRONICS, RMCFO603FG100K
18	2	R9, R10	RES., 0 $\Omega$ , 5%, 1/16W, 0402	ROHM, SFR01MZPJ000
19	1	R17	RES., 0 $\Omega$ , 1/10W, JUMPER, 0603	YAGEO, RC0603FR-070RL
20	1	R7	RES., 150k, 5%, 1/10W, 0603	YAGEO, RC0603JR-07150KL
21	1	Q1	XSTR, MOSFET, N-CH, 40V, TO-252 (DPAK)	VISHAY, SUD50N04-8M8P-4GE3
22	1	RS2	RES., SENSE, 0.005 $\Omega$ , 1%, 1W, 2512	VISHAY, WSL25125L000FEA
23	1	U1	IC, 20V, 12A STEP-DOWN $\mu$ Module REG.	ANALOG DEVICES, INC. LTM4626EY#PBF

### Additional Demo Board Circuit Components

24	0	C4, C9, C15, C36, C19, C43, C44	CAP, OPTION, 0603	OPTION
25	0	C13, C16, C22-C24, C37	CAP, OPTION, 0805	OPTION
26	0	C21, C20, C17	CAP, OPTION, 1206	OPTION
27	0	C25-C28	CAP, OPTION, 1210	OPTION
28	0	C39	CAP, OPTION, 0805, 3 PC PAD	MURATA, NFM21PC104R1E3D
29	0	C40	CAP, OPTION, 1206, 3 PC Pad	TDK, YFF31HC2A104MT000N
30	0	C41	CAP, OPTION, 0603, 3 PC PAD	MURATA, NFM18CC223R1C3D
31	0	C42	CAP, OPTION, 1206, 3 PC PAD	MURATA, NFM31PC276B0J3L
32	0	R18	RES., OPTION, 0805	OPTION
33	0	C35	CAP, OPTION, 0805	OPTION
34	0	R21-R23	RES., OPTION, 0402	OPTION
35	0	R1, R2, R5, R11-R13, R19, R20	RES., OPTION, 0603	OPTION
36	0	L1	IND., OPTION, 1812	OPTION
37	0	L2	IND., OPTION, 4mm x 4mm, AEX-Q200	COILCRAFT, XEL4020-800MEC

### Hardware: For Demo Board Only

38	10	E1, E3, E5, E6, E8-E12, E14	TESTPOINT, TURRET 0.064"	MILL-MAX, 2308-2-00-80-00-00-07-0
39	4	E2, E4, E7, E13	JACK, BANANA	KEYSTONE, 575-4
40	2	J1, J2	CONN, BNC, 5 PINS	AMPHENOL RF, 112404
41	5	JP1-JP6	HEADER, 1x2, 2mm	SULLINS, NRPNO21PAEN-RC
42	1	JP7	HEADER, 2x3, 2mm	SULLINS, NRPNO32PAEN-RC
43	1	JP8	HEADER, 1x3, 2mm	SAMTEC, TMM-103-02-L-S
44	4	MP1-MP4	STAND-OFF, NYLON 0.5"	KEYSTONE, 8833(SNAP ON)
45	3	XJP1, XJP7, XJP8	SHUNT, 2mm	SAMTEC, 2SN-BK-G

# DEMO MANUAL DC2665B-A

## SCHEMATIC DIAGRAM

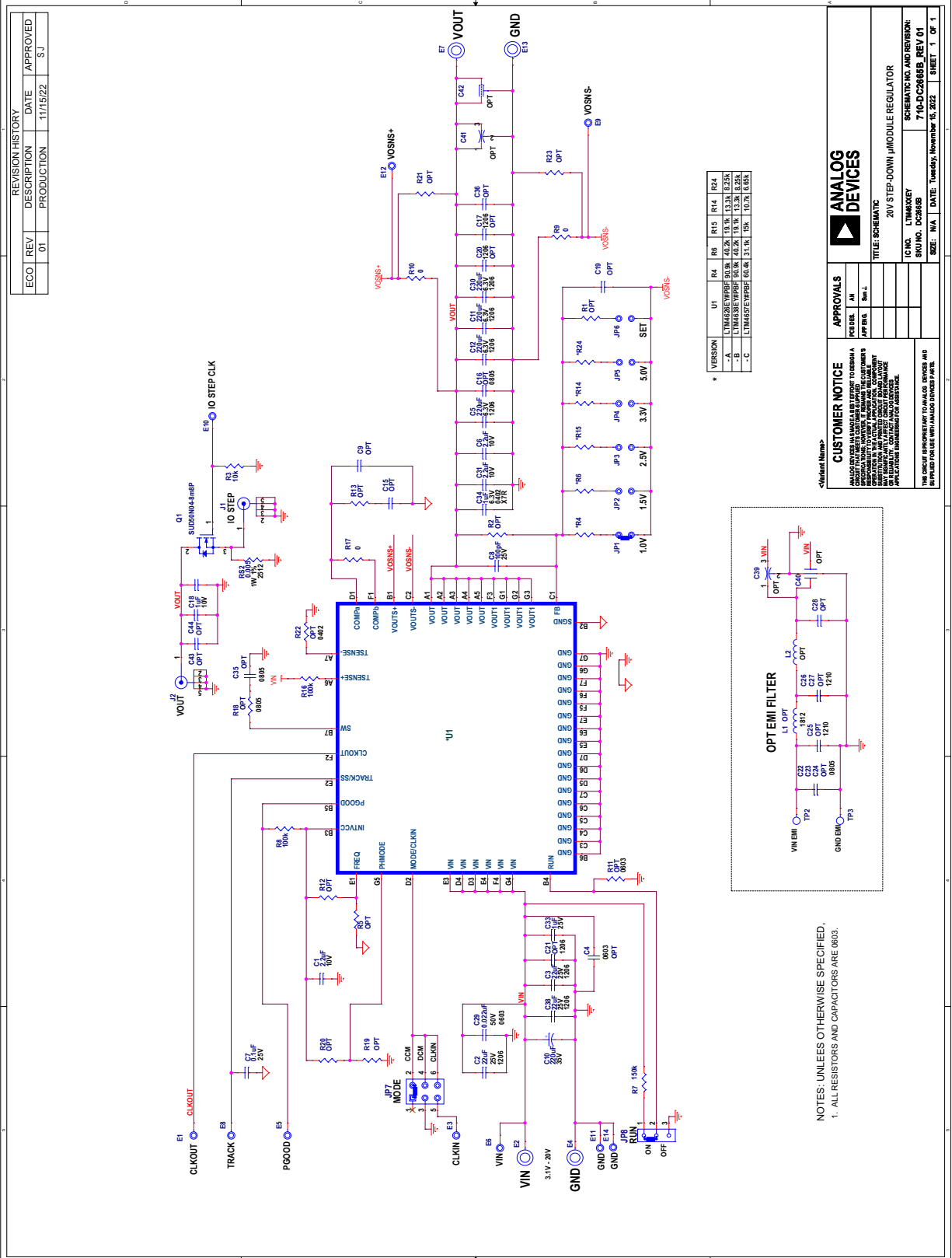



## REVISION HISTORY

DEMO BOARD REV	DEMO MANUAL REV	DATE	DESCRIPTION	PAGE NUMBER
DC2665A-A	0	02/19	Initial Release.	—
DC2665B-A	0	12/22	DC2665B-A replaces <a href="#">DC2665A-A</a> for low HF $V_{OUT}$ ripple.	—



## ESD Caution

**ESD (electrostatic discharge) sensitive device.** Charged devices and circuit boards can discharge without detection. Although this product features patented or proprietary protection circuitry, damage may occur on devices subjected to high energy ESD. Therefore, proper ESD precautions should be taken to avoid performance degradation or loss of functionality.

## Legal Terms and Conditions

By using the evaluation board discussed herein (together with any tools, components documentation or support materials, the "Evaluation Board"), you are agreeing to be bound by the terms and conditions set forth below ("Agreement") unless you have purchased the Evaluation Board, in which case the Analog Devices Standard Terms and Conditions of Sale shall govern. Do not use the Evaluation Board until you have read and agreed to the Agreement. Your use of the Evaluation Board shall signify your acceptance of the Agreement. This Agreement is made by and between you ("Customer") and Analog Devices, Inc. ("ADI"), with its principal place of business at One Technology Way, Norwood, MA 02062, USA. Subject to the terms and conditions of the Agreement, ADI hereby grants to Customer a free, limited, personal, temporary, non-exclusive, non-sublicensable, non-transferable license to use the Evaluation Board FOR EVALUATION PURPOSES ONLY. Customer understands and agrees that the Evaluation Board is provided for the sole and exclusive purpose referenced above, and agrees not to use the Evaluation Board for any other purpose. Furthermore, the license granted is expressly made subject to the following additional limitations: Customer shall not (i) rent, lease, display, sell, transfer, assign, sublicense, or distribute the Evaluation Board; and (ii) permit any Third Party to access the Evaluation Board. As used herein, the term "Third Party" includes any entity other than ADI, Customer, their employees, affiliates and in-house consultants. The Evaluation Board is NOT sold to Customer; all rights not expressly granted herein, including ownership of the Evaluation Board, are reserved by ADI. CONFIDENTIALITY. This Agreement and the Evaluation Board shall all be considered the confidential and proprietary information of ADI. Customer may not disclose or transfer any portion of the Evaluation Board to any other party for any reason. Upon discontinuation of use of the Evaluation Board or termination of this Agreement, Customer agrees to promptly return the Evaluation Board to ADI. ADDITIONAL RESTRICTIONS. Customer may not disassemble, decompile or reverse engineer chips on the Evaluation Board. Customer shall inform ADI of any occurred damages or any modifications or alterations it makes to the Evaluation Board, including but not limited to soldering or any other activity that affects the material content of the Evaluation Board. Modifications to the Evaluation Board must comply with applicable law, including but not limited to the RoHS Directive. TERMINATION. ADI may terminate this Agreement at any time upon giving written notice to Customer. Customer agrees to return to ADI the Evaluation Board at that time. LIMITATION OF LIABILITY. THE EVALUATION BOARD PROVIDED HEREUNDER IS PROVIDED "AS IS" AND ADI MAKES NO WARRANTIES OR REPRESENTATIONS OF ANY KIND WITH RESPECT TO IT. ADI SPECIFICALLY DISCLAIMS ANY REPRESENTATIONS, ENDORSEMENTS, GUARANTEES, OR WARRANTIES, EXPRESS OR IMPLIED, RELATED TO THE EVALUATION BOARD INCLUDING, BUT NOT LIMITED TO, THE IMPLIED WARRANTY OF MERCHANTABILITY, TITLE, FITNESS FOR A PARTICULAR PURPOSE OR NON-INFRINGEMENT OF INTELLECTUAL PROPERTY RIGHTS. IN NO EVENT WILL ADI AND ITS LICENSORS BE LIABLE FOR ANY INCIDENTAL, SPECIAL, INDIRECT, OR CONSEQUENTIAL DAMAGES RESULTING FROM CUSTOMER'S POSSESSION OR USE OF THE EVALUATION BOARD, INCLUDING BUT NOT LIMITED TO LOST PROFITS, DELAY COSTS, LABOR COSTS OR LOSS OF GOODWILL. ADI'S TOTAL LIABILITY FROM ANY AND ALL CAUSES SHALL BE LIMITED TO THE AMOUNT OF ONE HUNDRED US DOLLARS (\$100.00). EXPORT. Customer agrees that it will not directly or indirectly export the Evaluation Board to another country, and that it will comply with all applicable United States federal laws and regulations relating to exports. GOVERNING LAW. This Agreement shall be governed by and construed in accordance with the substantive laws of the Commonwealth of Massachusetts (excluding conflict of law rules). Any legal action regarding this Agreement will be heard in the state or federal courts having jurisdiction in Suffolk County, Massachusetts, and Customer hereby submits to the personal jurisdiction and venue of such courts. The United Nations Convention on Contracts for the International Sale of Goods shall not apply to this Agreement and is expressly disclaimed.