

ITEM NO.	PART NUMBER	DESCRIPTION	QTY.	COMPONENT NOTES
1	50-00024	Connector, dc plug, 5.5x2.1xL23 mm, molding style, spring contacts	1	
2	30-00683	Wire, 2C TS, 18 AWG, UL2464, 300V, 80C, 5.2 mm, VW-1, PVC	1	
3	24-00182	Overmold, dc plug, 5.5 mm, Tensility	1	PVC, black

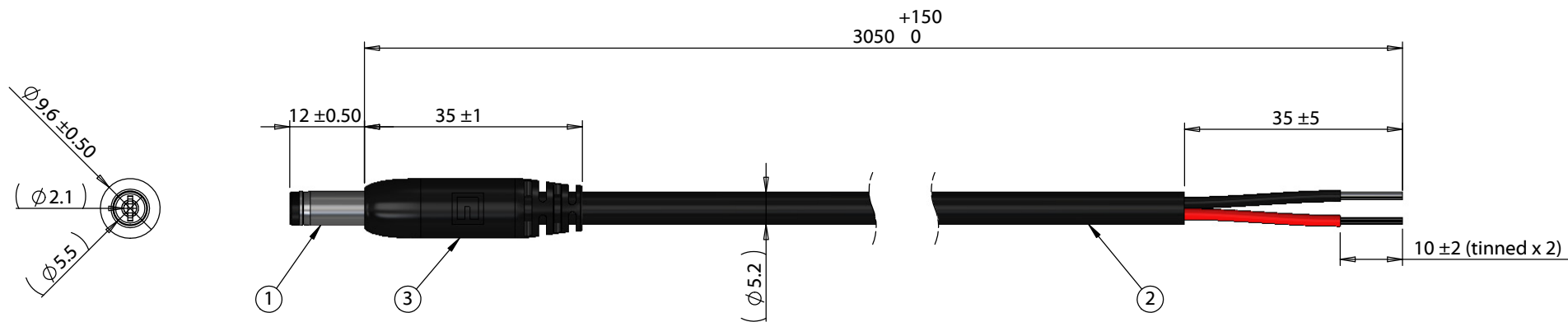

Notes:
Functionally equivalent components may be substituted

Wiring Diagram	
50-00024	wire color
center	red
sleeve	black

Revision:	Date:	Description:	Prepared:	Notes:	<h1>TENSILITY</h1> tel 1.541.323.3228 800 877.670.7118 fax 1.541.323.4202 web tensility.com
A	06/06/2019	Initial release	RS <small>Digitally signed by RS Date: 2019.06.06 15:54:24 -07'00'</small>		
			Verified:	Function test: no open, no short circuit, no intermittent	Size: Part number: A 10-03336
			JP <small>Digitally signed by JP Date: 2019.06.07 10:11:41 -07'00'</small>	Description:	
			Dimensions are in millimeters. Tolerances: X: ± 0.5 mm X.X: ± 0.3 mm X.XX: ± 0.05 mm	Cable, 3050 mm, 5.5x2.1x12 mm 50-00024 dc plug to stripped tinned, 18 AWG, 30-00683 wire	Scale: 1:1
					Sheet 1 of 1

5

4

3

2

1