

TM3TI8T

Analog input module, Modicon TM3, 8 temperature inputs (screw) 24 VDC



Main

Range of Product	Modicon TM3
Product or Component Type	Analog input module
Range Compatibility	Modicon M221 Modicon M241 Modicon M251 Modicon M262
Analogue input number	8
Analogue input type	Thermocouple - 200...1000 °C thermocouple J Thermocouple - 200...1300 °C thermocouple K Thermocouple 0...1760 °C thermocouple R Thermocouple 0...1760 °C thermocouple S Thermocouple 0...1820 °C thermocouple B Thermocouple - 200...400 °C thermocouple T Thermocouple - 200...1300 °C thermocouple N Thermocouple - 200...800 °C thermocouple E Thermocouple 0...2315 °C thermocouple C NTC 10k thermistor -90...150 °C PTC thermistor 100...10000 Ohm Thermocouple - 200...1000 °C

Complementary

Analogue input resolution	16 bits 15 bits + sign
Input impedance	>= 1 MOhm thermocouple >= 1 MOhm temperature probe >= 1 MOhm thermistor
LSB value	0.1 °C thermocouple 0.1 °C NTC 1 Ohm PTC/NTC
Conversion time	100 ms + 100 ms per channel + 1 controller cycle time
Sampling duration	100 ms
Absolute accuracy error	+/- 0.2 % of full scale 77 °F (25 °C) thermocouple C 0...2315 °C +/- 6 °C 77 °F (25 °C) thermocouple R, S 0...200 °C +/- 0.2 % of full scale 77 °F (25 °C) thermocouple R, S 200...1760 °C +/- 0.2 % of full scale 77 °F (25 °C) thermocouple B 300...1820 °C +/- 0.4 % of full scale 77 °F (25 °C) thermocouple K - 200...0 °C +/- 0.2 % of full scale 77 °F (25 °C) thermocouple K 0...1300 °C +/- 0.4 % of full scale 77 °F (25 °C) thermocouple J - 200...0 °C +/- 0.2 % of full scale 77 °F (25 °C) thermocouple J 0...1000 °C +/- 0.4 % of full scale 77 °F (25 °C) thermocouple E - 200...0 °C +/- 0.2 % of full scale 77 °F (25 °C) thermocouple E 0...800 °C +/- 0.4 % of full scale 77 °F (25 °C) thermocouple T - 200...0 °C +/- 0.2 % of full scale 77 °F (25 °C) thermocouple T 0...400 °C +/- 0.4 % of full scale 77 °F (25 °C) thermocouple N - 200...0 °C +/- 0.2 % of full scale 77 °F (25 °C) thermocouple N 0...1300 °C
Temperature drift	+/- 0.01 %FS/°C
Repeat accuracy	+/-0.5 %FS
Non-linearity	+/- 0.2 %FS
Cross talk	<= 1 LSB
[Us] rated supply voltage	24 V DC
Supply voltage limits	20.4...28.8 V
Type of cable	Twisted shielded pairs cable <98.43 ft (30 m) input
Current consumption	30 mA 24 V DC via external supply 45 mA 5 V DC via bus connector 40 mA 5 V DC via bus connector
Local signalling	For PWR 1 LED (green)

The information provided in this documentation contains general descriptions and/or technical characteristics of the performance of the products contained herein. This documentation is not intended as a substitute for and is not to be used for determining suitability or reliability of these products for specific user applications. It is the duty of any such user or integrator to perform the appropriate and complete risk analysis, evaluation and testing of the products with respect to the relevant specific application or use thereof. Neither Schneider Electric Industries SAS nor any of its affiliates or subsidiaries shall be responsible or liable for misuse of the information contained herein.

Electrical connection	10 x 1.5 mm ² removable screw terminal block pitch 3.81 mm for inputs and supply 10 x 1.5 mm ² removable screw terminal block pitch 3.81 mm for inputs
Insulation	Between input and supply 1500 V AC Between input and internal logic 500 V AC
Marking	CE
Surge withstand	1 KV power supply common mode EN/IEC 61000-4-5 0.5 KV power supply differential mode EN/IEC 61000-4-5 1 kV input common mode EN/IEC 61000-4-5
Mounting support	Top hat type TH35-15 rail IEC 60715 Top hat type TH35-7.5 rail IEC 60715 Plate or panel with fixing kit
Height	3.54 in (90 mm)
Depth	2.76 in (70 mm)
Width	0.93 in (23.6 mm)
Net Weight	0.24 lb(US) (0.11 kg)

Environment

Standards	EN/IEC 61010-2-201 EN/IEC 61131-2
Resistance to electrostatic discharge	8 KV in air EN/IEC 61000-4-2 4 kV on contact EN/IEC 61000-4-2
Resistance to electromagnetic fields	9.14 V/m (10 V/m) 80 MHz...1 GHz EN/IEC 61000-4-3 2.74 V/m (3 V/m) 1.4 GHz...2 GHz EN/IEC 61000-4-3 0.91 V/m (1 V/m) 2 GHz...3 GHz EN/IEC 61000-4-3
Resistance to magnetic fields	98.43 A/m (30 A/m) EN/IEC 61000-4-8
Resistance to fast transients	1 kV EN/IEC 61000-4-4 I/O)
Resistance to conducted disturbances	10 V 0.15...80 MHz EN/IEC 61000-4-6 3 V spot frequency (2, 3, 4, 6.2, 8.2, 12.6, 16.5, 18.8, 22, 25 MHz) Marine specification (LR, ABS, DNV, GL)
Electromagnetic emission	Radiated emissions 40 dB μ V/m QP class A 10 m)30...230 MHz EN/IEC 55011 Radiated emissions 47 dB μ V/m QP class A 10 m)230...1000 MHz EN/IEC 55011
Immunity to microbreaks	10 ms
Ambient Air Temperature for Operation	14...131 °F (-10...55 °C) horizontal installation 14...95 °F (-10...35 °C) vertical installation
Ambient Air Temperature for Storage	-13...158 °F (-25...70 °C)
Relative humidity	10...95 %, without condensation in operation) 10...95 %, without condensation in storage)
IP Degree of Protection	IP20
Pollution degree	2
Operating altitude	0...6561.68 ft (0...2000 m)
Storage altitude	0.00...9842.52 ft (0...3000 m)
Vibration resistance	3.5 mm 5...8.4 Hz DIN rail 3 gn 8.4...150 Hz DIN rail
Shock resistance	15 gn 11 ms







Ordering and shipping details

Category	22533 - M2XX PLC & ACCESSORIES
Discount Schedule	MSX
GTIN	3606480649028
Nbr. of units in pkg.	1
Package weight(Lbs)	7.41 oz (210 g)
Returnability	Yes
Country of origin	JP

Packing Units

Unit Type of Package 1	PCE
Package 1 Height	2.96 in (7.516 cm)
Package 1 width	4.21 in (10.685 cm)
Package 1 Length	5.02 in (12.739 cm)
Unit Type of Package 2	S02
Number of Units in Package 2	9
Package 2 Weight	5.27 lb(US) (2.391 kg)
Package 2 Height	5.91 in (15 cm)
Package 2 width	11.81 in (30 cm)
Package 2 Length	15.75 in (40 cm)

Offer Sustainability

Sustainable offer status	Green Premium product
California proposition 65	WARNING: This product can expose you to chemicals including: Lead and lead compounds, which is known to the State of California to cause cancer and birth defects or other reproductive harm. For more information go to www.P65Warnings.ca.gov
REACH Regulation	 REACH Declaration
EU RoHS Directive	Pro-active compliance (Product out of EU RoHS legal scope)  EU RoHS Declaration
Toxic heavy metal free	Yes
Mercury free	Yes
RoHS exemption information	 Yes
China RoHS Regulation	 China RoHS Declaration
Environmental Disclosure	 Product Environmental Profile
Circularity Profile	 End Of Life Information
WEEE	The product must be disposed on European Union markets following specific waste collection and never end up in rubbish bins.
PVC free	Yes

Dimensions

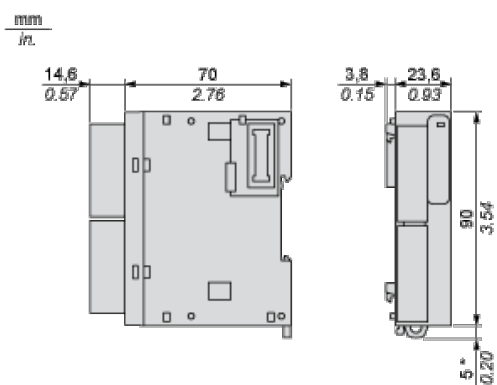

(*) 8.5 mm/0.33 in when the clamp is pulled out.

Spacing Requirements

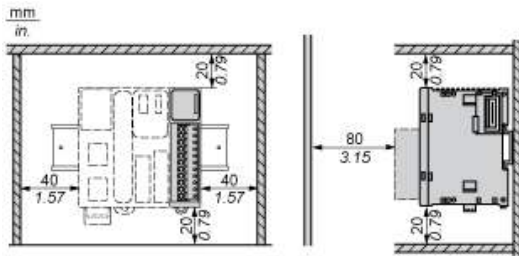

Mounting on a Rail

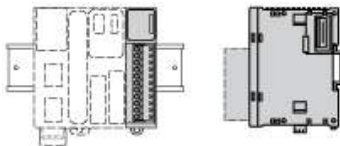

Incorrect Mounting

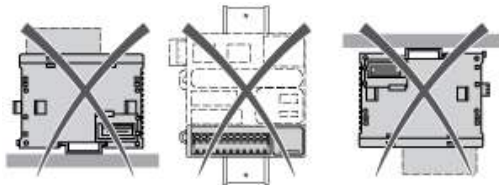

Mounting on a Panel Surface

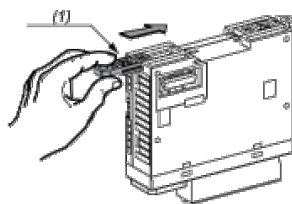

- (1) Install a mounting strip

Mounting Hole Layout

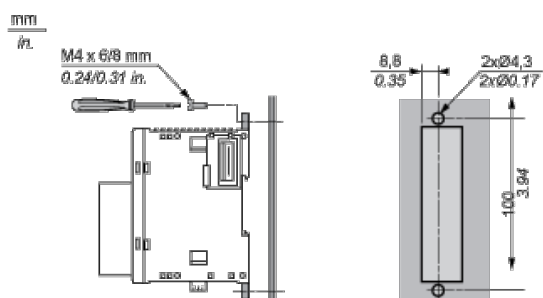

Analogue Input Module

Wiring Diagram (Thermocouple Input Type)

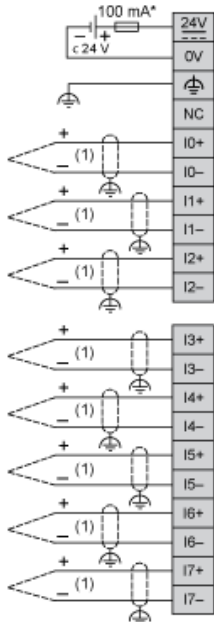

- (*) Type T fuse
- (1) Thermocouple

Wiring Diagram (Temperature Probe Input Type)

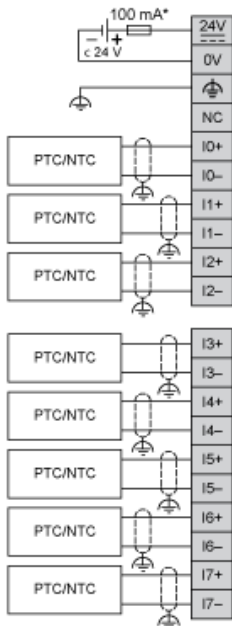

- (*) Type T fuse