

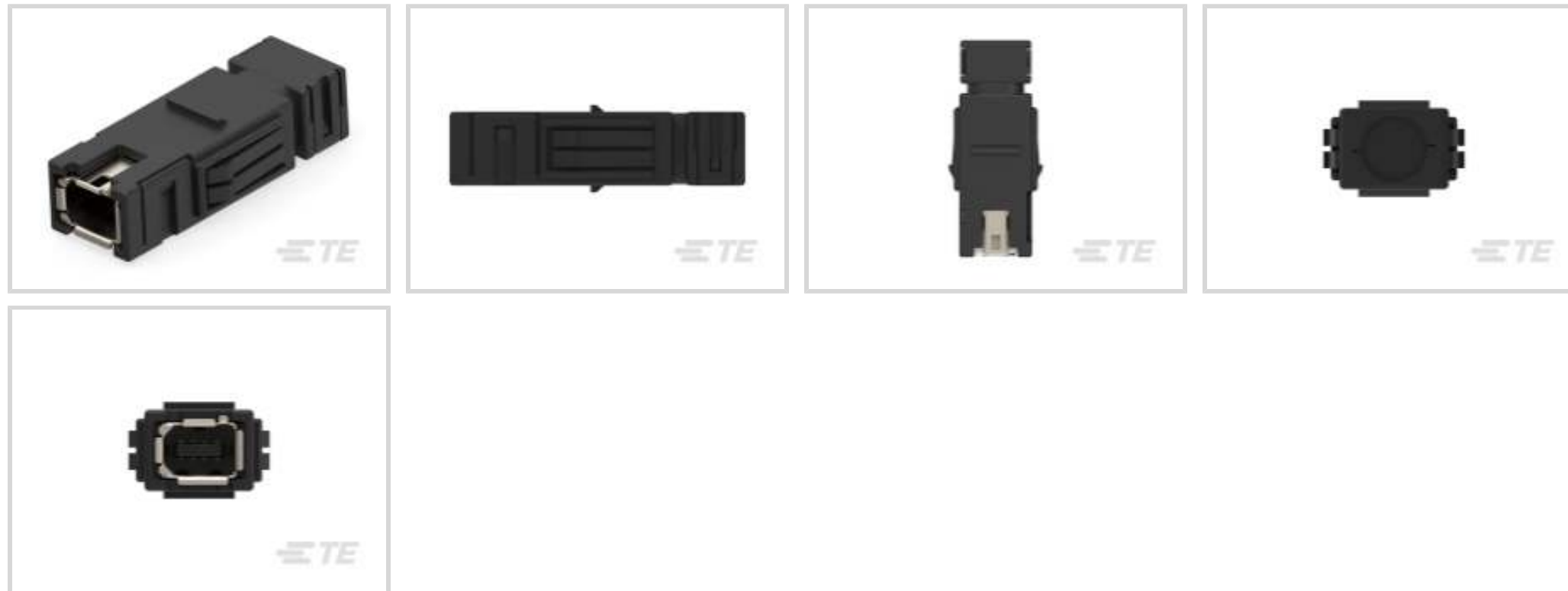

TE Internal #: 2201864-2
 Industrial Mini I/O Connectors, Industrial Mini I/O, High Connector
 Contact Density, Receptacle, Shielded, Cat 5e, Cable-to-Cable,
 Thermoplastic
[View on TE.com >](#)

Connectors > Modular Jacks & Plugs > Industrial Mini I/O Connectors > Mini I/O Receptacle Kit Type 1 Piercing



Modular Jacks & Plugs Products: **Industrial Mini I/O**

Connector Contact Density: **High**

Modular Connector Style: **Receptacle**

Shielded: **Yes**

Performance Category: **Cat 5e**

[All Mini I/O Receptacle Kit Type 1 Piercing \(3\)](#)

Features

Product Type Features

Connector Product Type	Connector Assembly
Modular Jacks & Plugs Products	Industrial Mini I/O
Modular Connector Style	Receptacle
Connector System	Cable-to-Cable
Connector & Contact Terminates To	Wire & Cable

Configuration Features

Port Matrix Configuration	1 x 1
Connector Contact Density	High
Number of Positions	8
Number of Loaded Positions	8

Signal Characteristics

Data Rate	10 Mb/s, 100 Mb/s, 1000 Mb/s
-----------	------------------------------

Body Features



Shield Material	Copper Alloy
-----------------	--------------

Shield Plating Material	Nickel
-------------------------	--------

Contact Features

Contact Mating Area Plating Material	Gold
--------------------------------------	------

Contact Underplating Material	Nickel
-------------------------------	--------

Contact Base Material	Copper Alloy
-----------------------	--------------

Contact Current Rating (Max)	1.5 A
------------------------------	-------

Mechanical Attachment

Mating Alignment Type	Keyed
-----------------------	-------

Mating Alignment	With
------------------	------

Panel Mount Feature	With
---------------------	------

Connector Mounting Type	Cable Mount (Free-Hanging)
-------------------------	----------------------------

Housing Features

Housing Color	Black
---------------	-------

Housing Material	Thermoplastic
------------------	---------------

Centerline (Pitch)	1.27 mm[.05 in]
--------------------	-----------------

Usage Conditions

Operating Temperature Range	-40 – 85 °C[-40 – 185 °F]
-----------------------------	---------------------------

Operation/Application

Shielded	Yes
----------	-----

Circuit Application	Power & Signal
---------------------	----------------

Industry Standards

UL Flammability Rating	UL 94V-0
------------------------	----------

Performance Category	Cat 5e
----------------------	--------

Packaging Features

Packaging Method	Blister Pack
------------------	--------------

Other

Modular Jacks & Plugs Comment	Type 1
-------------------------------	--------

Field Serviceable	No
-------------------	----

Product Compliance

For compliance documentation, visit the product page on [TE.com](https://www.te.com)>









EU RoHS Directive 2011/65/EU	Compliant
EU ELV Directive 2000/53/EC	Compliant
China RoHS 2 Directive MIIT Order No 32, 2016	No Restricted Materials Above Threshold
EU REACH Regulation (EC) No. 1907/2006	Current ECHA Candidate List: JUNE 2023 (235) Candidate List Declared Against: JAN 2023 (233) Does not contain REACH SVHC
Halogen Content	Not Low Halogen - contains Br or Cl > 900 ppm.
Solder Process Capability	Not applicable for solder process capability

Product Compliance Disclaimer

This information is provided based on reasonable inquiry of our suppliers and represents our current actual knowledge based on the information they provided. This information is subject to change. The part numbers that TE has identified as EU RoHS compliant have a maximum concentration of 0.1% by weight in homogenous materials for lead, hexavalent chromium, mercury, PBB, PBDE, DBP, BBP, DEHP, DIBP, and 0.01% for cadmium, or qualify for an exemption to these limits as defined in the Annexes of Directive 2011/65/EU (RoHS2). Finished electrical and electronic equipment products will be CE marked as required by Directive 2011/65/EU. Components may not be CE marked. Additionally, the part numbers that TE has identified as EU ELV compliant have a maximum concentration of 0.1% by weight in homogenous materials for lead, hexavalent chromium, and mercury, and 0.01% for cadmium, or qualify for an exemption to these limits as defined in the Annexes of Directive 2000/53/EC (ELV). Regarding the REACH Regulation, the information TE provides on SVHC in articles for this part number is based on the latest European Chemicals Agency (ECHA) 'Guidance on requirements for substances in articles' posted at this URL: <https://echa.europa.eu/guidance-documents/guidance-on-reach>

Compatible Parts

 <p>TE Part # 2201855-2 MINI I/O PLUG KIT TYPE I M</p>	 <p>TE Part # CAT-IN291-M6641M Mini I/O Field Installable Type 1</p>	 <p>TE Part # 2350323-1 MINI IO CONN Cat5e FI 2x2 AWG22 T I</p>	 <p>TE Part # 2271656-2 VERTICAL SMT TYPE MINI IO REC PLUS CONN</p>
 <p>TE Part # 1-2350304-1 MINI IO CONN Cat5e FI 2x2 AWG24 /26 T I</p>	 <p>TE Part # 1-2350310-1 MINI IO CONN Cat6A FI 4x2 AWG24 /26 T I</p>	 <p>TE Part # 1-2350323-1 MINI IO CONN Cat5e FI 2x2 AWG22 T I</p>	 <p>TE Part # 2350304-1 MINI IO CONN Cat5e FI 2x2 AWG24 /26 T I</p>



Customers Also Bought

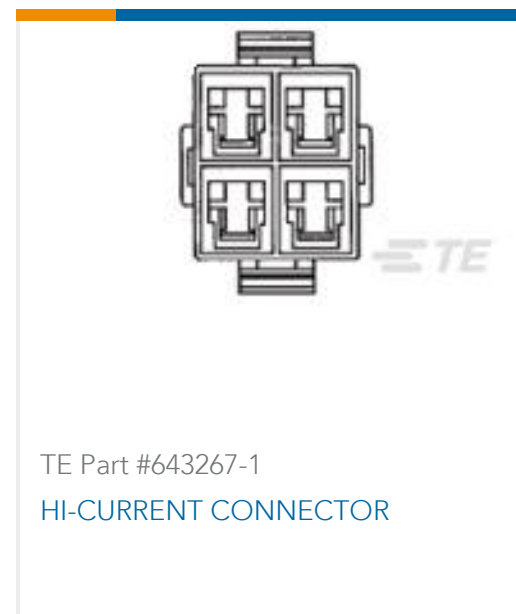
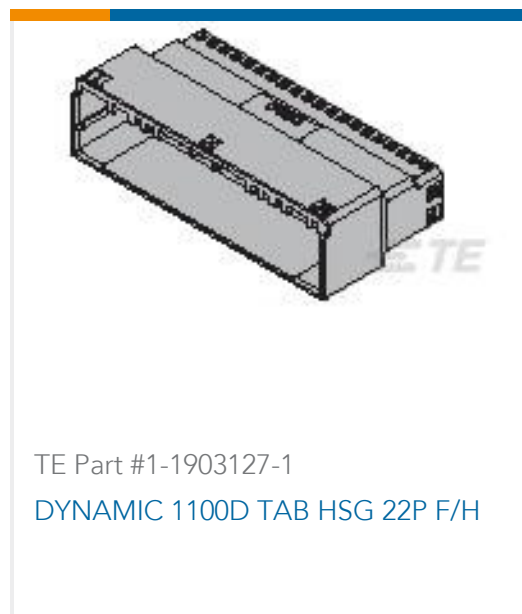

Documents

Product Drawings

MINI I/O REC KIT TYPE I M

English

CAD Files

Customer View Model

[ENG_CVM_CVM_2201864-2_B.3d_stp.zip](#)

English

Customer View Model

[ENG_CVM_CVM_2201864-2_B.2d_dxf.zip](#)

English

Customer View Model

[ENG_CVM_CVM_2201864-2_B.3d_igs.zip](#)

English

3D PDF

3D

By downloading the CAD file I accept and agree to the [Terms and Conditions](#) of use.



Datasheets & Catalog Pages

[1-1773733-2_MINI_IO_FIELD_INSTALLABLE_FLYER](#)

English

[1-1773733-2_MINI_IO_FIELD_INSTALLABLE_FLYER](#)

English

Product Specifications

[Application Specification](#)

English

Agency Approvals

[UL Report](#)

English