

**S21KAC-P03MPHO-200S**  
**series\_k, type\_s2**

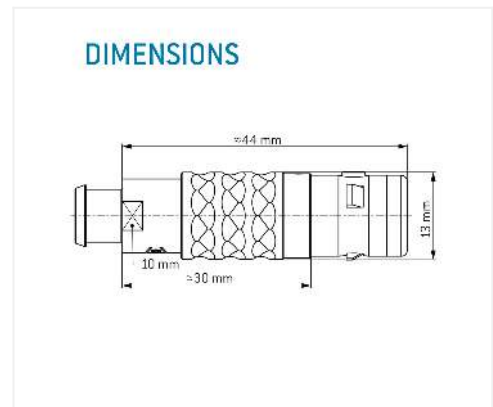

**General information**

<b>Part number</b>	S21KAC-P03MPHO-200S
<b>Termination</b>	solder
<b>Size</b>	1
<b>Locking principle</b>	push
<b>Coding</b>	a_key
<b>Cable Diameter</b>	cable_mini_20
<b>Cable outlet</b>	bend_relief

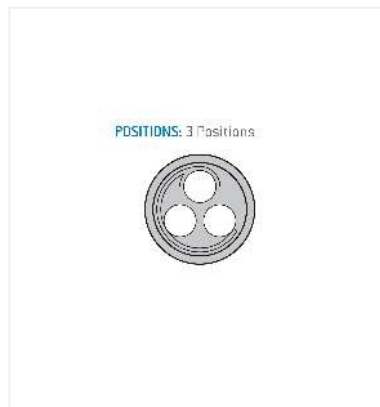

**Contact insert description**

<b>Number of contacts</b>	3
<b>Contact type</b>	pins
<b>Contact diameter</b>	13mm
<b>Insulator material</b>	peek
<b>Wire cross section</b>	20_awg
<b>Termination</b>	solder
<b>Termination diameter</b>	11mm

reverse\_gender\_on\_request

**Technical information**

<b>Max. creepage and air clearance distance</b>	09_mm	07_mm
<b>Nominal current single contact</b>	12_a	iec_60512_5_2
<b>Nominal current insert</b>	12 A	vde_0298_4
<b>Test voltage</b>	15_kv_ac	sae_13441

safety\_text

## Mechanical and environmental data

Degree of protection*	ip68
Operating temperature	40_120_c
Mating cycles	5000

mated

## Material and surface treatments

Housing	m_chrome
Contact	cu_alloy_gold

safety\_text\_2  
ul\_text  
illustrative\_text