

## SPECIFICATIONS

Mega Zenigata with Natural Toning

# GW6TGBJC50C

2 000K ~ 3 000K

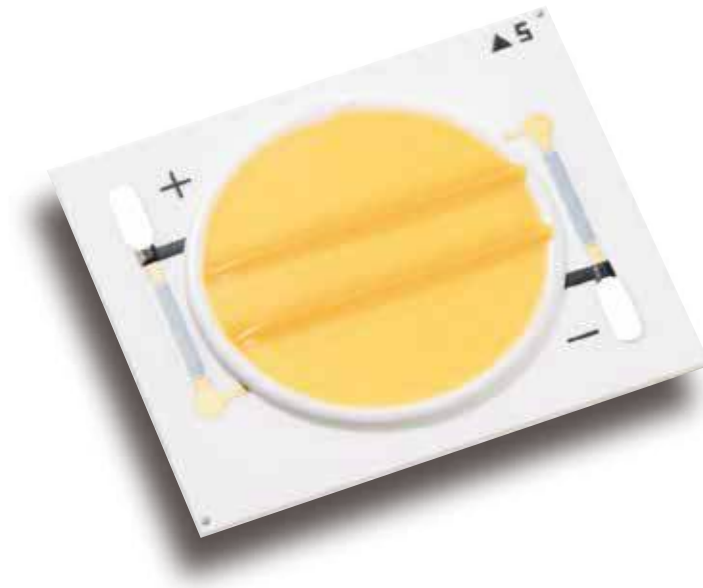

## ZENIGATA

### Notice

Contents in this technical document be changed without any notice due to the product modification. In the absence of confirmation by device specification sheets, SHARP takes no responsibility for any defects that may occur in wquipment using any SHARP devices shown in catalogs, data books, etc.

"Contents in this technical document be changed without any notice due to the product modification." <http://www.sharp-world.com/products/device/>

- Handle this document carefully for it contains material protected by international copyright law. Any reproduction, full or in part, of this material is prohibited without the express written permission of the company.
- When using the products covered herein, please observe the conditions written herein and the precautions outlined in the following paragraphs. In no event shall the company be liable for any damages resulting from failure to strictly adhere to these conditions and precautions.

(1) Please do verify the validity of this part after assembling it in customer's products, when customer wants to make catalogue and instruction manual based on the specification sheet of this part.

(2) The products covered herein are designed and manufactured for the following application areas.

When using the products covered herein for the equipment listed in paragraph (3), even for the following application areas, be sure to observe the precautions given in Paragraph (3). Never use the products for the equipment listed in Paragraph (4).

\*Office electronics

\*Instrumentation and measuring equipment

\*Machine tools

\*Audiovisual equipment

\*Home appliances

\*Communication equipment other than for trunk lines

(3) These contemplating using the products covered herein for the following equipment which demands high reliability, should first contact a sales representative of the company and then accept responsibility for incorporating into the design fail-safe operation, redundancy, and other appropriate measures for ensuring reliability and safety of the equipment and the overall system.

\*Control and safety devices for airplanes, trains, automobiles, and other transportation equipment

\*Mainframe computers

\*traffic control systems

\*Gas leak detectors and automatic cutoff devices

\*Rescue and security equipment

\*Other safety devices and safety equipment, etc.

(4) Do not use the products covered herein for the following equipment which demands extremely high performance in terms of functionality, or accuracy.

\*Aerospace equipment

\*Communications equipment for trunk lines

\*Control equipment for the nuclear power industry

\*Medical equipment related to life support, etc.

(5) please direct all queries and comments regarding the interpretation of the above four Paragraphs to a sales representative of the company.

- Please direct all queries regarding the products covered herein to a sales representative of the company.

## GW6TGBJC50C Specifications

### 1. Application

These specifications apply to the light emitting diode module Model No. GW6TGBJC50C.

[ LED module (InGaN Blue LED chip + Phosphor) ]

Main application : Lighting

2. External dimensions and equivalent circuit \_\_\_\_\_ Refer to Page 2.

3. Ratings and characteristics \_\_\_\_\_ Refer to Page 3-6.

- 3-1. Absolute maximum ratings
- 3-2. Electro-optical characteristics
- 3-3. Derating curve
- 3-4. Characteristics diagram (TYP.)

4. Reliability \_\_\_\_\_ Refer to Page 7.

- 4-1. Test items and test conditions
- 4-2. Failure criteria

5. Quality level \_\_\_\_\_ Refer to Page 8.

- 5-1. Applied standard
- 5-2. Sampling inspection
- 5-3. Inspection items and defect criteria

6. Supplements \_\_\_\_\_ Refer to Page 9-12.

- 6-1. Chromaticity rank table
- 6-2. Packing
- 6-3. Label
- 6-4. Indication printed on product

7. Precautions \_\_\_\_\_ Refer to Page 13-16.

2. External dimensions and equivalent circuit

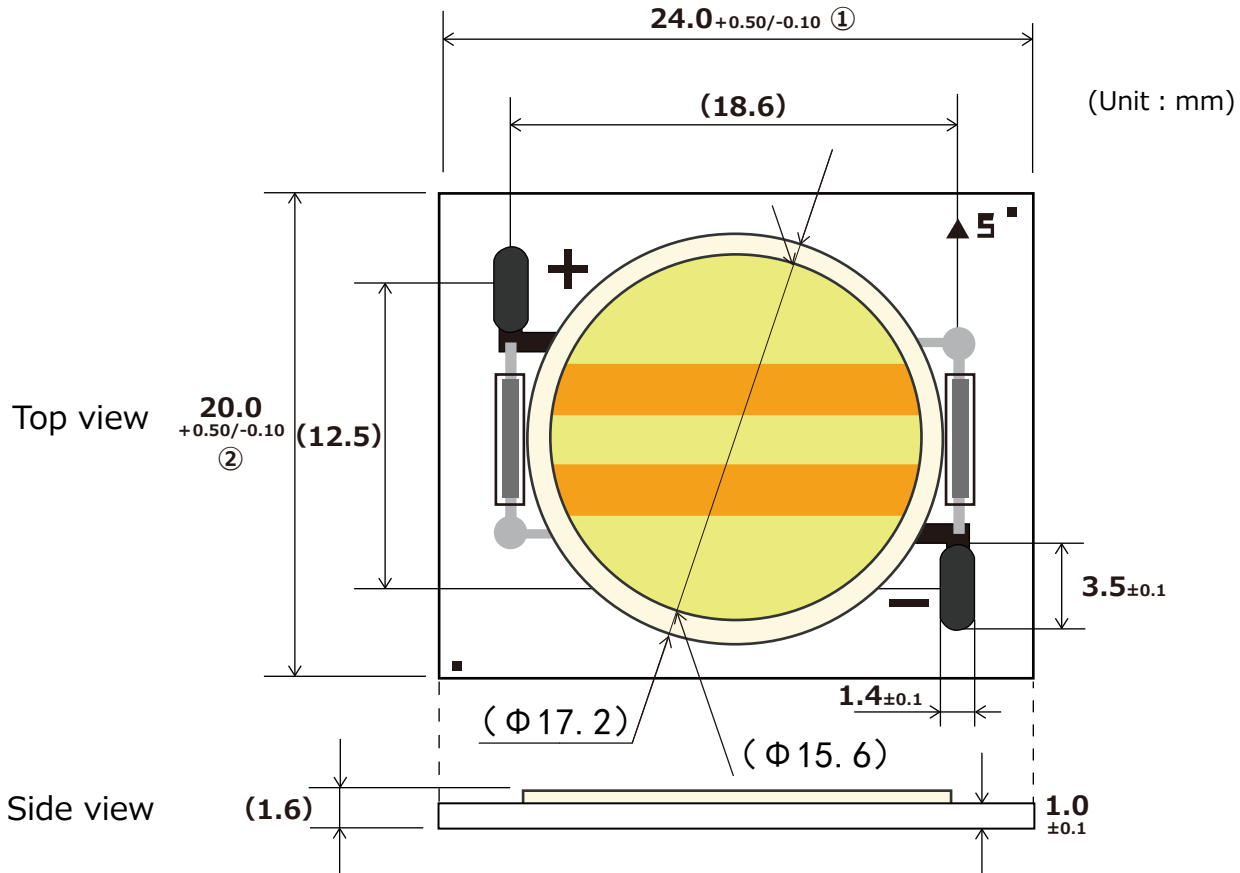

(Note) Values inside parentheses are reference values.  
 External sizes of①、②are determined by maximum dimensions, that include salient areas on the edges of respective sides.

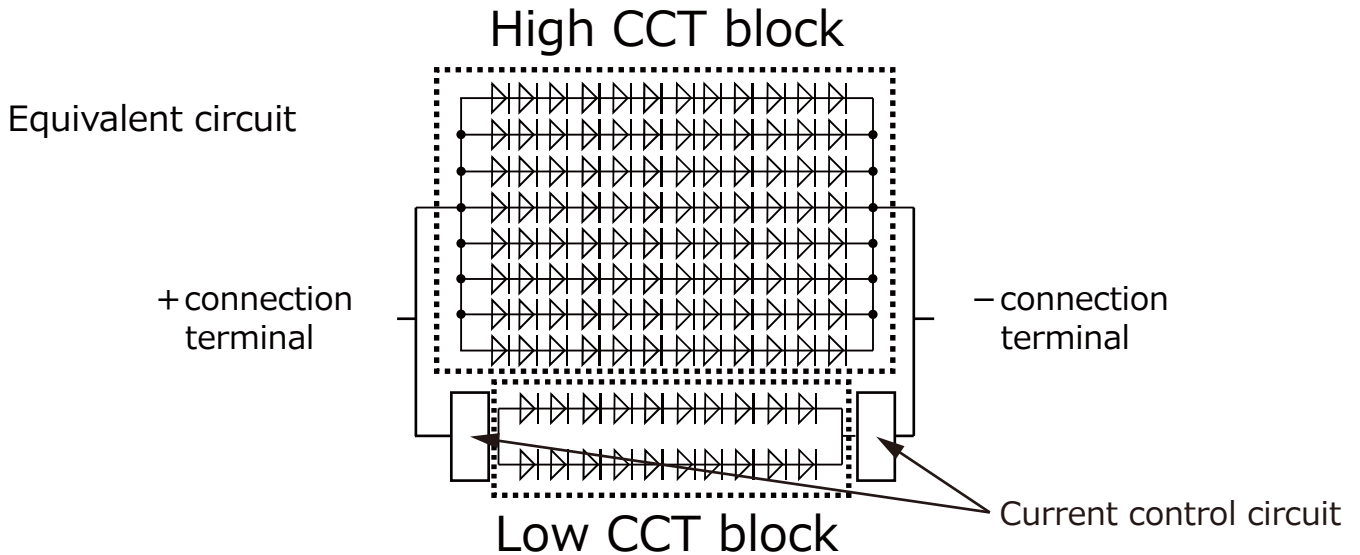

High CCT block 12 series × 8 parallel = 96 pcs of LEDs  
 Low CCT block 10 series × 2 parallel = 20 pcs of LEDs

Unit	Material	Drawing No.
mm	Substrate : Alumina Ceramic	52605044

### 3. Ratings and characteristics

#### 3-1. Absolute maximum ratings

Item	Symbol	Rating	Unit
Power Dissipation (※1,4)	P	41.6	W
Forward Current (※1,4)	I <sub>F</sub>	1 050	mA
Reverse Voltage (※2,4)	V <sub>R</sub>	-15	V
Operating Temperature (※3)	T <sub>opr</sub>	-30 ~ +100	°C
Storage Temperature	T <sub>stg</sub>	-40 ~ +100	°C
Junction Temperature	T <sub>j</sub>	145	°C

\*1 Power dissipation and forward current are the values when the module temperature is set lower than the rating by using an adequate heat sink.

\*2 The maximum rating of reverse voltage is assumed, after considering the voltage that occur due to initial connection error that may occur suddenly.

(Not dealing with the possibility of always-on reverse voltage.)

\*3 Operating temperature is the Case temperature T<sub>c</sub>

(Refer to measuring point for case temperature in the next page.)

Refer to "Derating curve" in the next page as for operating current.

\*4 T<sub>c</sub> = 25°C

### 3-2. Electro-optical characteristics

(T<sub>j</sub> = 25°C)

CCT	Item	Symbol	Condition	MIN.	TYP.	MAX.	Unit
2000K	Forward Voltage※5	V <sub>F</sub>	I <sub>F</sub> = 80mA	25.8	(30.4)	33.4	V
	Luminous Flux※ 6	Φ		120	(155)	-	lm
	Chromaticity Coordinates※ 7	x		-	(0.5251)	-	-
		y		-	(0.4120)	-	-
	General Color Rendering Index※8	Ra		90	(94)	-	-
3000K	Forward Voltage※5	V <sub>F</sub>	I <sub>F</sub> = 950mA	30.5	(35.8)	39.6	V
	Luminous Flux※ 6	Φ		2430	(2860)	-	lm
	Chromaticity Coordinates※ 7	x		-	(0.4370)	-	-
		y		-	(0.4030)	-	-
	General Color Rendering Index※8	Ra		90	(92)	-	-

(Note) Values inside parentheses are shown for reference purpose only.

\*5 (After 5 ms drive, Measurement tolerance: ± 3 %)

\*6 Monitored by Sharp's 1m integrating sphere and Otsuka electronics SR-2000A  
(After 5 ms drive, Measurement tolerance: ± 10 %)

\*7 Monitored by Sharp's 1m integrating sphere and Otsuka electronics SR-2000A  
(After 5 ms drive, Measurement tolerance: ± 0.005)

\*8 Monitored by Sharp's 1m integrating sphere and Otsuka electronics SR-2000A  
(After 5 ms drive, Measurement tolerance: ± 2)

3-3. Derating curve

Forward Current Derating Curve

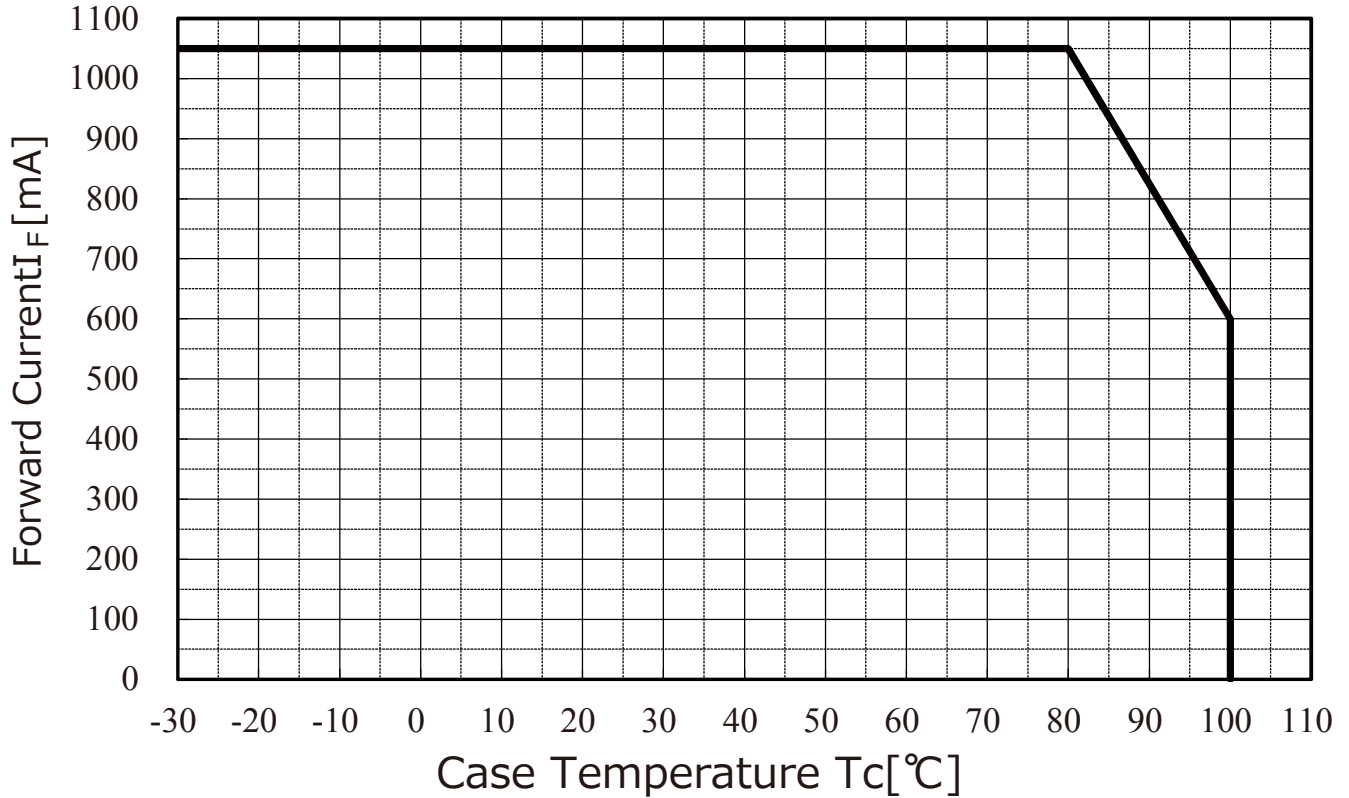

(Note) To keep the case temperature lower than the rating, enough heat-radiation performance needs to be secured by using an adequate heat sink.

For soldering connection, please evaluate in your circumstance to make sure soldering reliability.  
 ( Above derating curve is specified to LED device, not for soldering connection )  
 And please consider to avoid physical stress between wire and substrate,  
 and some protection like silicon bond on top of soldered wire is recommended.  
 Please ensure the maintenance of heat radiation not to exceed case temperature over the rating  
 in operation.

(Measuring point for case temperature)

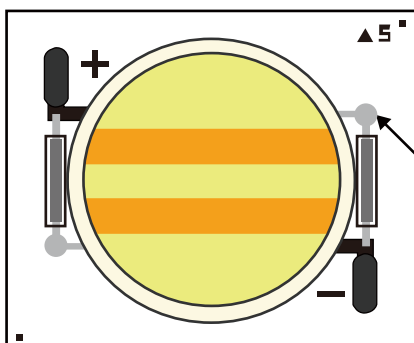

Please take note of the following, when measuring case temperature.  
 1 The LED device mounting surface should be flat/plain surface.  
 2 The substrate surface temperature should be uniform.  
 3 Do not solder this area when you measuring case temperature.

measuring point

Thermal Resistance : 1.30°C/W (Typical value)

"Contents in this technical document be changed without any notice due to the product modification." <http://www.sharp-world.com/products/device/>

### 3-4.Characteristics diagram(TYP.)

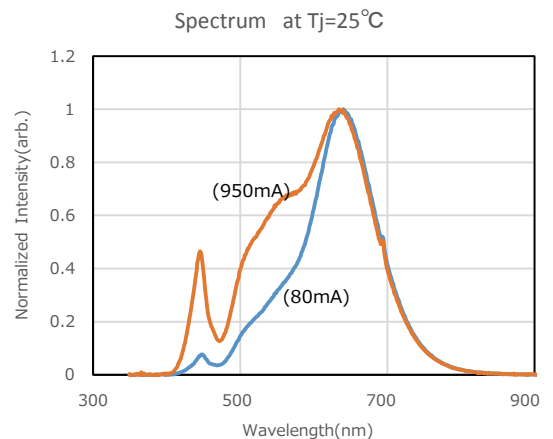
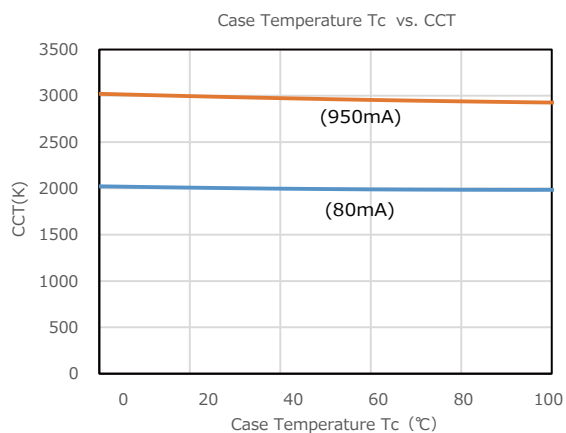
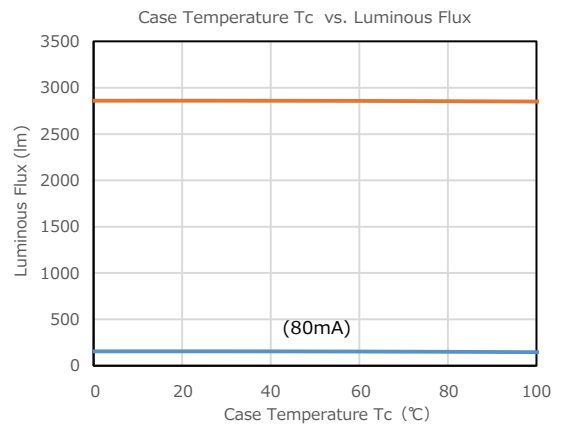
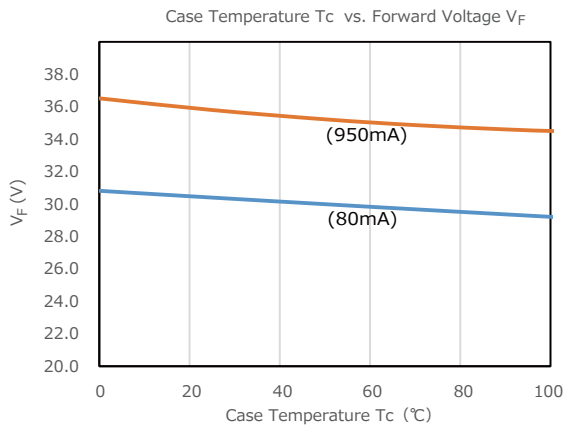
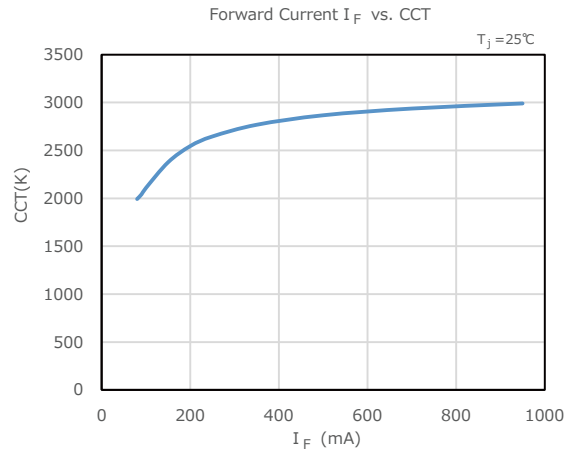
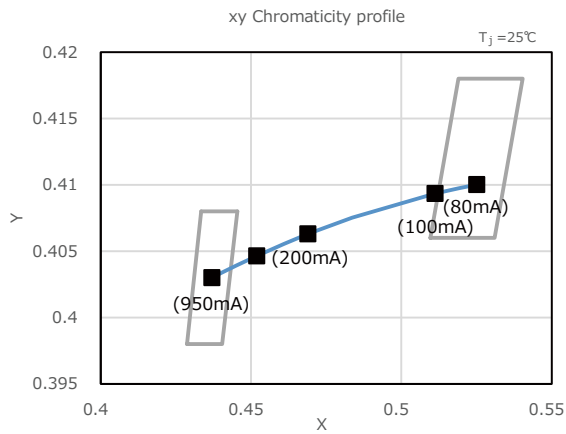
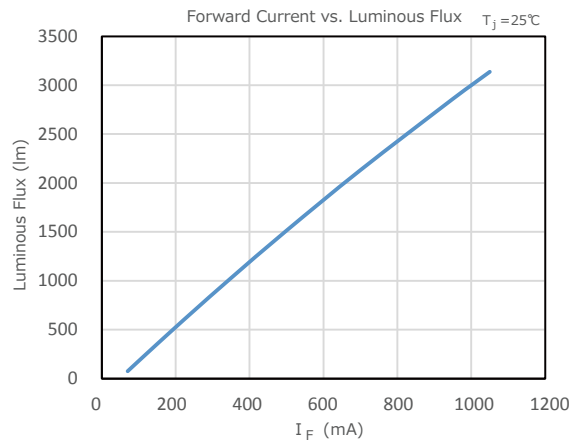
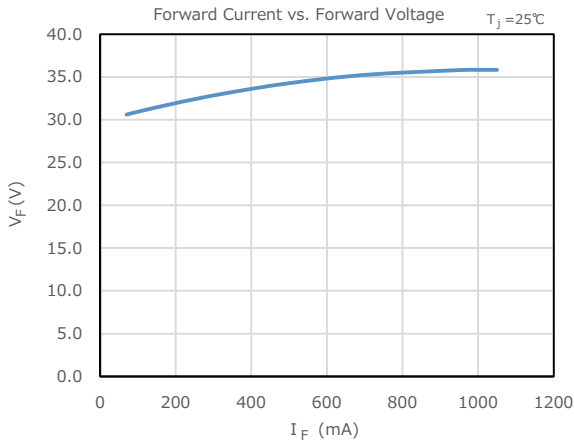



## 4. Reliability

The reliability of products shall be satisfied with items listed below.

### 4-1. Test items and test conditions

Confidence level : 90%

No.	Test item	Test conditions	samples n	Defective C	LTPD (%)
1	Temperature Cycle	- 40 °C(30 min) ~ + 100 °C(30 min), 100 cycles	11	0	20
2	Temperature Humidity Storage	Tstg = + 60 °C, RH = 90 %, Time = 1000 h	11	0	20
3	High Temperature Storage	Tstg = + 100°C, Time = 1000 h	11	0	20
4	Low Temperature Storage	Tstg = - 40 °C, Time = 1000 h	11	0	20
5	Steady State Operating Life	Tc = 80 °C, I <sub>F</sub> = 950 mA, Time = 1000 h	11	0	20
6	Shock	Acceleration: 15000 m/s <sup>2</sup> , Pulse width: 0.5 ms Direction: 3 directions (X, Y and Z) 3 trials in each direction	5	0	50
7	Vibration	Frequency: 100 to 2000 Hz for 4 minutes per trial Acceleration: 200 m/s <sup>2</sup> Direction: 3 directions (X, Y and Z) 4 trials in each direction	5	0	50

### 4-2. Failure criteria

No.	Parameter	Symbol	Failure criteria
1	Forward Voltage	V <sub>F</sub>	V <sub>F</sub> > Initial value×1.1
2	Luminous Flux	Φ	Φ < Initial value×0.7

## 5. Quality level

5-1. Applied standard (ISO2859-1)

5-2. Sampling inspection (A single normal sampling plan, level S-4)

5-3. Inspection items and defect criteria

No.	Item	Defect criteria	Classification	AQL
1	No radiation	No light emitting	Major defect	0.1
2	Electro-optical characteristics	Not conforming to the specification (Forward voltage, Luminous flux and Chromaticity values)	Minor defect	0.4
3	External dimensions	Not conforming to the specification (External dimensions of ① and ② shown in Page2)		
4	Appearance	Nonconformity observed in product appearance is determined as defective only when electro-optical characteristics is affected by. <If any question arises regardless of above mentioned criterion> <ul style="list-style-type: none"> <li>■ Foreign material, scratch, or bubble at emitting area: 0.8mm</li> <li>■ Fiber generation at emitting area: 0.2mm ib width and 2.5mm in length</li> <li>■ Foreign material at connection terminal: 0.8mmΦ</li> <li>■ Substrate burr on edge: Over dimension tolerance</li> </ul>		

(Note) Products with removable foreign material attached on is not determined to be defective.

## 6. Supplements

### 6-1.Chromaticity rank table (Tolerance : $x,y\pm 0.005$ )

( $T_j=25^\circ\text{C}$ )

Rank			Chromaticity coordinates			
			Point 1	Point 2	Point 3	Point 4
1	2 000K ( $I_F=80\text{mA}$ )	x	0.5097	0.5311	0.5404	0.5190
		y	0.4060	0.4060	0.4180	0.4180
	3 000K ( $I_F=950\text{mA}$ )	x	0.4287	0.4404	0.4454	0.4334
		y	0.3980	0.3980	0.4080	0.4080

## Chromaticity Diagram

---- Black Body curve

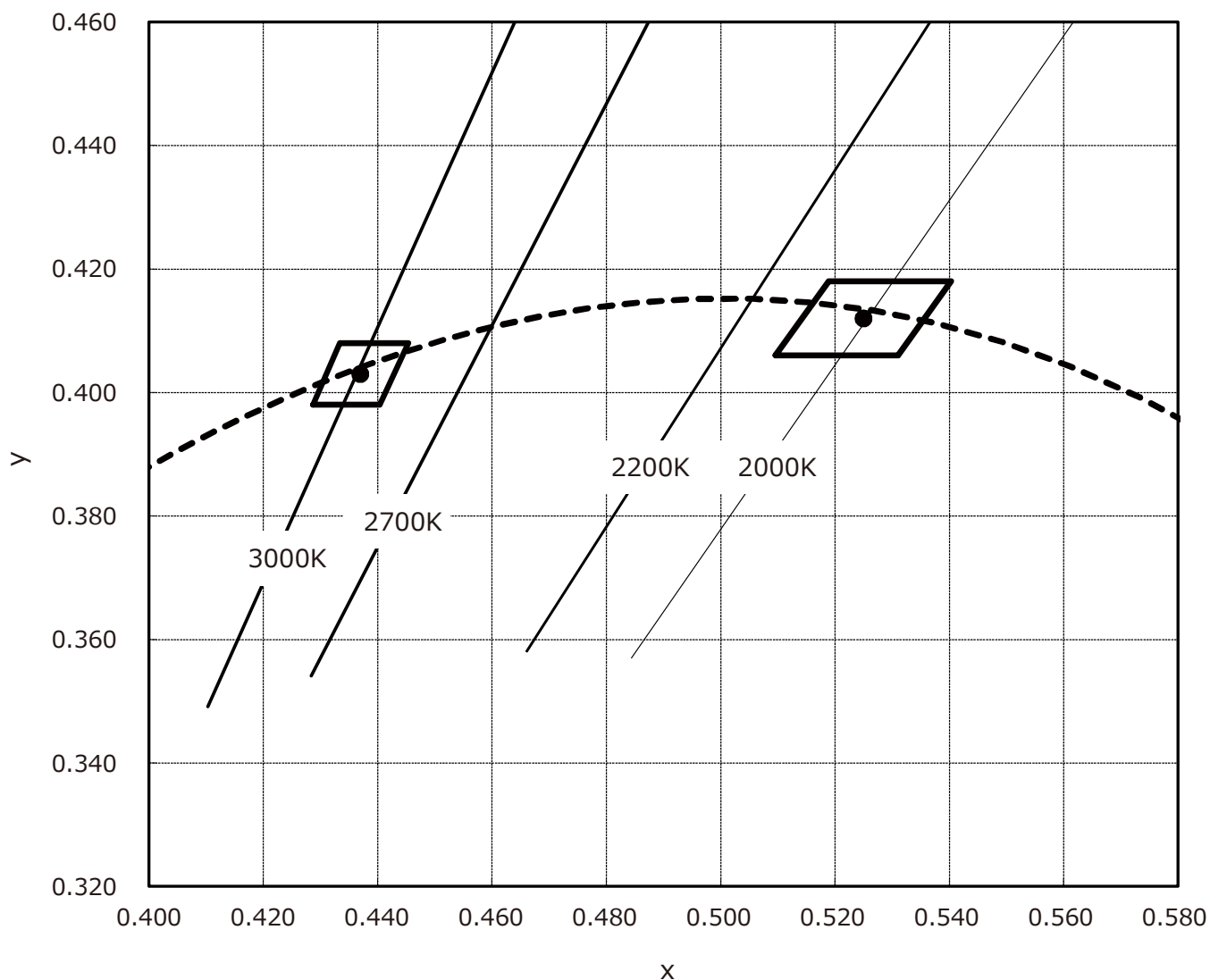

## 6-2.Packing

- One tray composed of 40 pieces
  - 5 trays(200 pieces)and one upper lid-tray in one moisture-proof bag
  - 2 bags(400 pieces) in one carton
  - Dimensions of outer carton:235×220×90mm (Reference value)
- (Note 1)Thre are cases of one carton composed of one bag (200 pieces)
- (Note 2) State of packing is dublic to change.

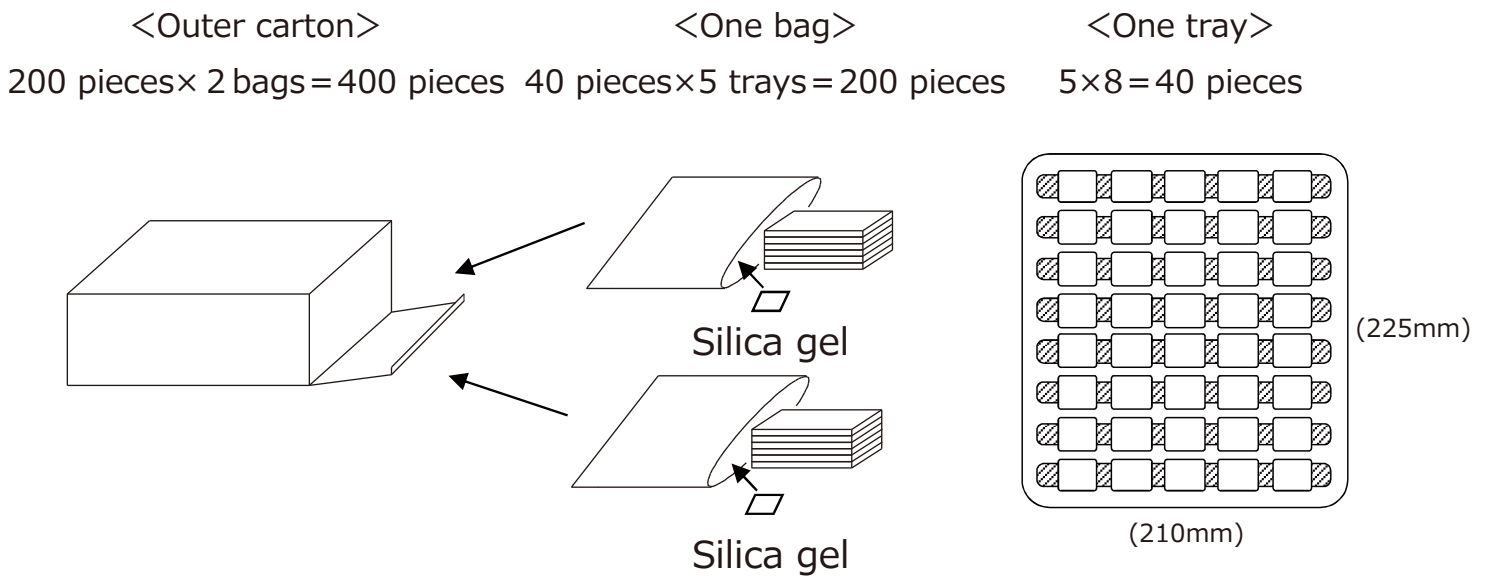

## 6-3.Label

### 1) Outer carton

Following label is attached on outer carton.

(Note 3) Label format is subjected to change.

SHIPMENT TABLE	
PART No. GW6TGBJC50C	←Model number
(GW6TGBJC50CX)	←(Model number+ suffix code)
QUANTITY : 400	←Quantity
LOT No. XX12B01	←Lot No.
RANK 1	←Rank
SHARP CORPORATION	←Production country
MADE IN ***** RC	• MADE IN ****
SHARP LABEL	

### • Lot No.indication

XX 11 B 25  
① ② ③ ④

①Production plant code

②Shipping year (Year last 2 digits)

③Shipping month

(from january to DoccMBER in ABC order)

④Shipping date (01 ~ 31)

※Notation may be different

### • Lot No.indication

XX 1 9 G 11 123 A  
① ② ③ ④ ⑤ ⑥ ⑦

①Production plant code

②Shipping year (Year last digit)

③Shipping month (1 ~ 9 or O,N,D)

④Fixed code G

⑤Shipping date (01 ~ 31)

⑥Serial No.

⑦Backup code A

※Notation may be different

### 2)Moisture-Proof bag

Following label is attached on moisture-proof bags.

(Note 3) Label format is subjected to change.

SHIPMENT TABLE	
PART No. GW6TGBJC50C	←Model number
(GW6TGBJC50CX)	←(Model number+suffix code)
QUANTITY : 200 RANK 1	←Quantity
LOT No. XX20G01054A	←Lot No.
SHARP CORPORATION	←Production country
MADE IN ***** RC	• MADE IN ****
SHARP LABEL	

## 6-4. Indication printed on product

Model No. and control No. are indicated on substrate surface.

### 1) Model No. & Rank:

1st line:Abbreviated Model No 'GBJCC ' is indicated."

2nd line:Rank:

### 2) Control No.

Indicated as follows;

12 B 11  
① ② ③

① Year of production (the last two figures of the year)

② Month of production

(to be indicated alphabetically with January corresponding to A)

③ Date of production (01~31)

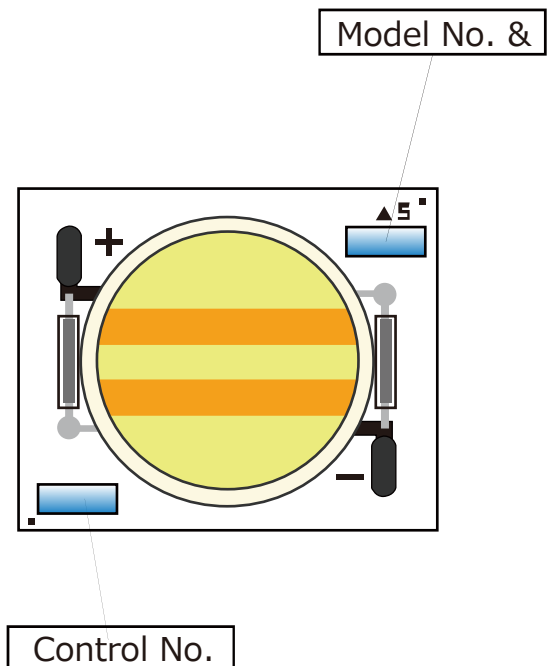

## 7. Precautions

### ① Storage conditions

Please follow the conditions below.

- Before open: Temperature 5 ~ 30°C, Relative humidity less than 60%.

(Before opened LED should be used within a year)

- After opened: Temperature 5 ~ 30°C, Relative humidity less than 60%.

(Please apply soldering within 1 week)

- Avoid exposing to air with corrosive gas.

If exposed, electrode surface would be damaged, which may affect soldering.

### ② Usage conditions

This product is not designed for use under any of the following conditions.

Please carefully check the performance and reliability well enough in case of using under any of the following conditions;

- In a place with a lot of moisture, dew condensation, briny air, and corrosive gas.

(CL, H<sub>2</sub>S, NH<sub>3</sub>, SO<sub>2</sub>, NO<sub>x</sub>, etc)

- Under the direct sunlight, outdoor exposure, and in a dusty place.
- In water, oil, medical fluid, and organic solvent.

Please do not use component parts like rubber which may contain sulfur (gasket packing, adhesive material, etc.)

Please note that any strong acidic or alcoholic elements could affect the silicon resin used in the LED device.

The heat and light released from the LED device, could generate halogen gas from the surrounding materials, which may have adverse impact on the module. Before using please consider carefully about this issue.

### ③ Heat radiation and Installation

If forward current ( $I_F$ ) is applied to single-state module at any current, there is a risk of damaging LED or emitting smoke, due to increase in temperature.

Equip with specified heat radiator (heat sink), and avoid heat being stuffed inside the module.

Material of substrate is alumina ceramic. If installed inappropriately, trouble of insufficient heat radiation may occur, which may result in board cracks or lighting defects due to overheat.

Please take particular notice for installation.

Refer to the following cautions while installing the LED device on heat sink.

- Apply thermolysis adhesive, adhesive sheet or peculiar connector when mounted on heat radiator.

In case of applying adhesive or adhesive sheet only, check the effectiveness and reliability before fixing. If LED comes off from heat radiator, unusual temperature rise entails hazardous phenomena including device deterioration, coming off of solder at leads, and emitting smoke, along with LED device defects.

"Contents in this technical document be changed without any notice due to the product modification." <http://www.sharp-world.com/products/device/>

- When LED device is mechanically fixed or locked, Please take into consideration regarding the method of attachment due to fail from stress.
- Please apply appropriate stress and design carefully, when fixing the LED device using holder. Any excessive or uneven stress could break LED device' s substrate.
- Avoid convexly uneven boards. Convex board is subject to substrate cracking or debasement of heat release.
- It is recommented to apply adhesive or adhesive sheet with high thermal conductivity for radiation of heat effectively.
- Please take care about the influence of color change of adhesive or adhesive sheet in initial and long termperiod, which may affect light output or color due to change of reflectance from backside.
- Any excessive or uneven stress on the ceramic substrate could break the substrate.

Please design such that, proper/uniform stress is applied on the substrate, when fixing the LED device using a holder.

- When fixing the LED device with a holder, please take note if any excessive or uneven stress is applied when pressing the substrate with holder. Due to this, the gap may arise between LED device and adhesive material, which may affect the heat dissipation of the device.

- Do not touch resin part including white resin part on the surface of LED.

No light emission may occur due to damage of resin or cutting wire of LEDs by outer force.

When using tweezers, please handle by side part of ceramic or the specified area shown below.

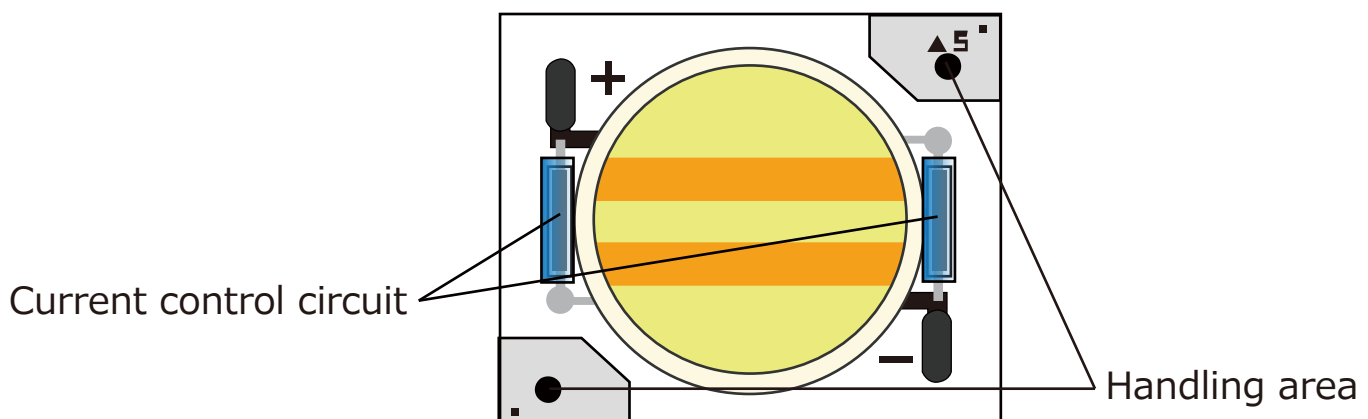

- The outer edges of the substrate may be uneven in some cases. Please avoid choosing these areas as fixing points, while designing for installation.
- In case of using heat radiation sheet or heat radiation adhesive, light reflection or absorption of these materials may influence the output of LED device. and hence careful consideration is required while choosing the radiation sheet ro adhesive.

#### ④ Connecting method

Use soldering for connections. Follow the conditions mentioned below, to preserve the connection strength.

- Use soldering iron with thermo controller (tip temperature 380°C, within 5 seconds per one place).

"Contents in this technical document be changed without any notice due to the product modification." <http://www.sharp-world.com/products/device/>

- Secure the solderwettability on whole solder pad and leads.
- During the soldering process, put the ceramic board on materials whose conductivity is poor enough not to radiate heat of soldering.
- Warm up (with using a heated plate) the substrate is recommended before soldering. (preheat condition: 100°C ~ 150°C, within 60sec)
- Avoid touching any part of resin with soldering iron.
- This product is not designed for reflow and flow soldering.
- Avoid such lead arrangement as applying stress to solder-applied area.
- Please do not detach solder and make re-solder.
- Please solder evenly on each electrode.
- Please prevent flux from touching to resin.
- Do the soldering on stable stand. Avoid soldering on moving or vibrating objects.
- Please avoid touching the soldering unit to resin.

#### ⑤ Static electricity

This product is subject to static electricity, so take measures like wearing wrist band to cope with it. Install circuit protection device to drive circuit, if necessary.

#### ⑥ Drive method

- Any reverse voltage cannot be applied to LEDs when they are in operation or not. Design a circuit so that any flow of reverse or forward voltage can not be applied to LEDs when they are out of operation.
- Module is composed of LEDs connected in both series and parallel. Constant voltage power supply runs off more than specified current amount due to lowered VF caused by temperature rise. Constant current power supply is recommended to drive.
- Be cautious while putting on/off the power supply, as excess current, excess voltage or reverse voltage may get injected to the device in some cases.

#### ⑦ Cleaning

Avoid cleaning, since LED device may be effected in some cases by cleaning.

#### ⑧ Color-tone variation

Chromaticity of this product is monitored by integrating sphere right after the operation. Chromaticity varies depending on measuring method, light spread condition, or ambient temperature. Please verify your actual conditions before use.



### ⑨ Safety

- Looking directly at LEDs for a long time may result in hurting your eyes.
- In case that excess current(over ratings)is supplied to the device,hazardous phenomena including abnormal heat generation,emitting smoke,or catching fire can caused.  
Take appropriate measures to excess current and voltage.
- In case of solder connecting method,there is a possibility of fatigue failure by heat.  
Please fix the leads in such case to protect from short circuit or leakage of electricity caused by contact.
- Please confirm the safety standards or regulations of application devices.
- Please be careful with substrate edges,that may injure your hands.

### ⑩ Other cautions

Guarantee covers the compliance to the quality standards mentioned in the specifications, however it does not cover the compatibility with application of the end-use,including assembly and usage environment.

In case any quality problems occurred in the application of end-use,details will be separately discussed and determined between the parties hereto.

# SHARP

<http://www.sharp-world.com/products/device/>