

Nut - QPD N 4PE2,5 6-11 BK - 1459663

Please be informed that the data shown in this PDF Document is generated from our Online Catalog. Please find the complete data in the user's documentation. Our General Terms of Use for Downloads are valid (<http://phoenixcontact.com/download>)



QUICKON nut, black, 4+PE-pos., 1.0 mm² ... 2.5 mm²/690 V/20 A, for cables with 6 mm ... 11 mm diameter.

Why buy this product

- Innovative and time saving - QUICKON fast connection for time saving of up to 80 % for on-site connection
- Convenient: quick and easy assembly without special tools
- Robust throughout: housing with IP68/IP69K and IK07 protection for a wide range of applications



Key Commercial Data

Packing unit	1 STK
Custom tariff number	39269097
Country of origin	Poland

Technical data

General

Type	QPD 5x2,5
Color	black
Locking type	Screw locking
Connection method	QUICKON connection
	IDC connection
Number of positions	5
Note number of positions	4+PE
Wrench size, union nut	27 mm
Tightening torque, union nut	10 Nm
Number of connections	10

Nut - QPD N 4PE2,5 6-11 BK - 1459663

Technical data

General

Conductor cross section flexible min.	1 mm ²
Conductor cross section flexible max.	2.5 mm ²
Conductor cross section solid min.	1 mm ²
Conductor cross section solid max.	2.5 mm ²
Conductor cross section AWG min.	16
Conductor cross section AWG max.	14

Cabel

Structure of individual litz in acc. with VDE 0295 / smallest wire diameter	VDE 0295 class 1 to 6/min. 0.15 mm
Wire insulation material	PVC/PE/TPE/rubber
Wire diameter including insulation	2.5 mm ... 3.8 mm
External cable diameter	6 mm ... 11 mm

Ambient conditions

Degree of protection	IP68 ()
	IP69K
Ambient temperature (operation)	-40 °C ... 80 °C
Ambient temperature (storage/transport)	-40 °C ... 80 °C
Temperature when conductor connected	-5 °C ... 50 °C

Electrical characteristics

Nominal current I _N	20 A
Rated current	20 A
Rated voltage (III/3)	690 V
Rated voltage (III/2)	1000 V
Rated voltage (II/2)	1000 V
Rated surge voltage (III/3)	8 kV
Rated surge voltage (III/2)	8 kV
Rated surge voltage (II/2)	8 kV

Mechanical characteristics

QUICKON connectability	max. 10
------------------------	---------

Material data

Contact carrier material	PA
Insulating material	PA
Flammability rating according to UL 94	V0
Overvoltage category	III
Degree of pollution	3

Standards and Regulations

Nut - QPD N 4PE2,5 6-11 BK - 1459663

Technical data

Standards and Regulations

Flammability rating according to UL 94	V0
--	----

Drawings

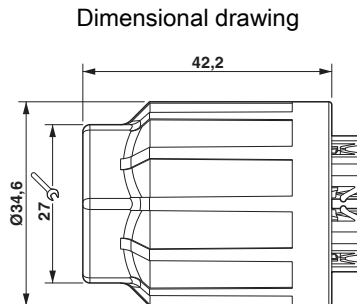

Dimensional drawing of the QPD nut 5x2,5

Classifications

eCl@ss

eCl@ss 4.0	272607xx
eCl@ss 4.1	27260701
eCl@ss 5.0	27143424
eCl@ss 5.1	27143424
eCl@ss 6.0	27143424
eCl@ss 7.0	27440209
eCl@ss 8.0	27440605
eCl@ss 9.0	27440605

ETIM

ETIM 3.0	EC002382
ETIM 4.0	EC000516
ETIM 5.0	EC002560

UNSPSC

UNSPSC 6.01	30211923
UNSPSC 7.0901	39121522
UNSPSC 11	39121522
UNSPSC 12.01	39121522
UNSPSC 13.2	39121522

Nut - QPD N 4PE2,5 6-11 BK - 1459663

Approvals

Approvals

Approvals

VDE Zeichengenehmigung / IEC EE CB Scheme / GL / EAC

Ex Approvals

Approvals submitted

Approval details

VDE Zeichengenehmigung 	
mm ² /AWG/kcmil	1.0-2.5
Nominal current I _N	20 A
Nominal voltage U _N	690 V

IECEE CB Scheme 	
Nominal voltage U _N	690 V

GL

EAC
