

## **EKI-7758F**

**8G ports Industrial Managed  
Redundant Gigabit Ethernet  
Switch, 4 Gigabit Copper  
and 4 Gigabit SFP**

**User Manual**

## **Copyright**

The documentation and the software included with this product are copyrighted 2010 by Advantech Co., Ltd. All rights are reserved. Advantech Co., Ltd. reserves the right to make improvements in the products described in this manual at any time without notice. No part of this manual may be reproduced, copied, translated or transmitted in any form or by any means without the prior written permission of Advantech Co., Ltd. Information provided in this manual is intended to be accurate and reliable. However, Advantech Co., Ltd. assumes no responsibility for its use, nor for any infringements of the rights of third parties, which may result from its use.

## **Acknowledgements**

Microsoft Windows and MS-DOS are registered trademarks of Microsoft Corp.  
All other product names or trademarks are properties of their respective owners.

## **Product Warranty (2 years)**

Advantech warrants to you, the original purchaser, that each of its products will be free from defects in materials and workmanship for two years from the date of purchase.

This warranty does not apply to any products which have been repaired or altered by persons other than repair personnel authorized by Advantech, or which have been subject to misuse, abuse, accident or improper installation. Advantech assumes no liability under the terms of this warranty as a consequence of such events.

Because of Advantech's high quality-control standards and rigorous testing, most of our customers never need to use our repair service. If an Advantech product is defective, it will be repaired or replaced at no charge during the warranty period. For out-of-warranty repairs, you will be billed according to the cost of replacement materials, service time and freight. Please consult your dealer for more details.

If you think you have a defective product, follow these steps:

1. Collect all the information about the problem encountered. (For example, network speed, Advantech products used, other hardware and software used etc.) Note anything abnormal and list any onscreen messages you get when the problem occurs.
2. Call your dealer and describe the problem. Please have your manual, product, and any helpful information readily available.
3. If your product is diagnosed as defective, obtain an RMA (return merchandise authorization) number from your dealer. This allows us to process your return more quickly.
4. Carefully pack the defective product, a fully-completed Repair and Replacement Order Card and a photocopy proof of purchase date (such as your sales receipt) in a shippable container. A product returned without proof of the purchase date is not eligible for warranty service.
5. Write the RMA number visibly on the outside of the package and ship it prepaid to your dealer.

## Declaration of Conformity

### CE

This product has passed the CE test for environmental specifications. Test conditions for passing included the equipment being operated within an industrial enclosure. In order to protect the product from being damaged by ESD (Electrostatic Discharge) and EMI leakage, we strongly recommend the use of CE-compliant industrial enclosure products.

### FCC Class A

This equipment has been tested and found to comply with the limits for a Class A digital device, pursuant to Part 15 of the FCC Rules. These limits are designed to provide reasonable protection against harmful interference when the equipment is operated in a commercial environment. This equipment generates, uses and can radiate radio frequency energy and, if not installed and used in accordance with the instruction manual, may cause harmful interference to radio communications. Operation of this equipment in a residential area is likely to cause harmful interference in which case the user will be required to correct the interference at his own expense.

## Technical Support and Assistance

- Step 1. Visit the Advantech web site at [www.avanotech.com/support](http://www.avanotech.com/support) where you can find the latest information about the product.
- Step 2. Contact your distributor, sales representative, or Advantech's customer service center for technical support if you need additional assistance. Please have the following information ready before you call:
  - Product name and serial number
  - Description of your peripheral attachments
  - Description of your software (operating system, version, application software etc.)
  - A complete description of the problem
  - The exact wording of any error messages

## Safety Instructions

1. Read these safety instructions carefully.
2. Keep this User's Manual for later reference.
3. Disconnect this equipment from any AC outlet before cleaning. Use a damp cloth. Do not use liquid or spray detergents for cleaning.
4. For plug-in equipment, the power outlet socket must be located near the equipment and must be easily accessible.
5. Keep this equipment away from humidity.
6. Put this equipment on a reliable surface during installation. Dropping it or letting it fall may cause damage.
7. The openings on the enclosure are for air convection. Protect the equipment from overheating. **DO NOT COVER THE OPENINGS.**
8. Make sure the voltage of the power source is correct before connecting the equipment to the power outlet.
9. Position the power cord so that people cannot step on it. Do not place anything over the power cord.
10. All cautions and warnings on the equipment should be noted.
11. If the equipment is not used for a long time, disconnect it from the power source to avoid damage by transient over voltage.
12. Never pour any liquid into an opening. This may cause fire or electrical shock.
13. Never open the equipment. For safety reasons, the equipment should be opened only by qualified service personnel.
14. If one of the following situations arises, get the equipment checked by service personnel:
  - a. The power cord or plug is damaged.
  - b. Liquid has penetrated into the equipment.
  - c. The equipment has been exposed to moisture.
  - d. The equipment does not work well, or you cannot get it to work according to the user's manual.
  - e. The equipment has been dropped and damaged.
  - f. The equipment has obvious signs of breakage.
15. **DO NOT LEAVE THIS EQUIPMENT IN AN ENVIRONMENT WHERE THE STORAGE TEMPERATURE MAY GO BELOW -40°C (-40°F) OR ABOVE 85°C (185°F). THIS COULD DAMAGE THE EQUIPMENT. THE EQUIPMENT SHOULD BE IN A CONTROLLED ENVIRONMENT.**

## **Safety Precaution - Static Electricity**

Follow these simple precautions to protect yourself from harm and the products from damage.

1. To avoid electrical shock, always disconnect the power from your equipment chassis before you work on it.
2. Disconnect power before making any configuration changes.

# Contents

<b>Chapter 1</b>	<b>Overview.....</b>	<b>2</b>
1.1	Introduction .....	2
1.1.1	The SFP Advantage .....	2
1.1.2	High-Speed Transmissions .....	2
1.1.3	Dual Power Inputs .....	2
1.1.4	Flexible Mounting .....	2
1.1.5	Wide Operating Temperature .....	3
1.1.6	Easy Troubleshooting.....	3
1.2	Features .....	4
1.3	Specifications .....	5
1.4	Packing List.....	7
1.5	Safety Precaution.....	7
<b>Chapter 2</b>	<b>Installation.....</b>	<b>10</b>
2.1	LED Indicators.....	10
	Table 2.1: EKI-7758F LED Definition.....	10
2.2	Dimensions (units: mm) .....	11
	Figure 2.2-1 Front View of EKI-7758F.....	11
	Figure 2.2-2 Side View of EKI-7758F .....	12
	Figure 2.2-3 Rear View of EKI-7758F.....	13
	Figure 2.2-4 Top View of EKI-7758F.....	14
2.3	Mounting .....	15
2.3.1	Wall mounting.....	15
	Figure 2.3-1 Combine the Metal Mounting Kit.....	15
2.3.2	DIN-rail Mounting.....	16
	Figure 2.3-2 Installation to DIN-rail Step 1.....	16
	Figure 2.3-3 Installation to DIN-rail Step 2.....	17
2.4	Network Connection.....	18
2.5	Connection to a Fiber Optic Network .....	18
	Figure 2.5-1 Transceiver to the SFP slot .....	18
	Figure 2.5-2 Transceiver Inserted.....	19
	Figure 2.5-3 LC connector to the transceiver .....	19
	Figure 2.5-4 Remove LC connector .....	20
	Figure 2.5-5 Pull out from the transceiver.....	20
2.6	Power Connection.....	21
	Figure 2.6-1 Pinouts of the Power Connector .....	21
2.7	X-Ring Application.....	22
2.8	Coupling Ring Application .....	23
2.9	Dual Homing Application.....	24
<b>Chapter 3</b>	<b>Configuration .....</b>	<b>26</b>
3.1	RS-232 Console.....	26
	Figure 3.1-1 Console Cable .....	26
	Figure 3.1-2 Launching Hyper Terminal.....	26
	Figure 3.1-3 COM Port Properties Setting .....	27

Figure 3.1-4	Login Screen: RS-232 Configuration .....	27
Figure 3.1-5	Command Line Interface .....	28
<b>3.2</b>	<b>Commands Set .....</b>	<b>29</b>
3.2.1	Commands Level.....	29
Table 3.1:	Command Level.....	29
3.2.2	Commands Set List .....	29
Table 3.2:	Commands Set List.....	29
3.2.3	System Commands Set.....	30
Table 3.3:	System Commands Set .....	30
3.2.4	Port Commands Set .....	31
Table 3.4:	Port Commands Set .....	31
3.2.5	Trunk Commands Set.....	32
Table 3.5:	Trunk Commands Set .....	32
3.2.6	VLAN Commands Set .....	32
Table 3.6:	VLAN Commands Set.....	32
3.2.7	Spanning Tree Commands Set .....	33
Table 3.7:	Spanning Tree Commands Set.....	33
3.2.8	QOS Commands Set.....	34
Table 3.8:	QOS Commands Set.....	34
3.2.9	IGMP Commands Set.....	35
Table 3.9:	QOS Commands Set.....	35
3.2.10	Mac/Filter Table Commands Set .....	35
Table 3.10:	Mac/Filter Table Commands Set.....	35
3.2.11	SNMP Commands Set .....	35
Table 3.11:	SNMP Commands Set .....	35
3.2.12	Port Mirroring Commands Set .....	36
Table 3.12:	Port Mirroring Commands Set.....	36
3.2.13	802.1x Commands Set .....	37
Table 3.13:	802.1x Commands Set .....	37
3.2.14	TFTP Commands Set.....	38
Table 3.14:	TFTP Commands Set.....	38
3.2.15	SystemLog, SMTP and Event .....	38
Table 3.15:	SysLog,SMTP,Event Commands Set.....	38
3.2.16	SNTP Commands Set .....	39
Table 3.16:	SNTP Commands Set .....	39
3.2.17	X-ring Commands Set .....	39
Table 3.17:	X-ring Commands Set .....	39
<b>3.3</b>	<b>Web Browser.....</b>	<b>40</b>
Figure 3.4-1	Type the address in the URL .....	40
Figure 3.4-2	Web Login Window .....	40
Figure 3.4-3	Main Page .....	41
3.3.1	System.....	42
Figure 3.4-4	System Information.....	42
Figure 3.4-5	IP Configuration.....	43
Figure 3.4-6	DHCP Server - System Configuration.....	44
Figure 3.4-7	DHCP Server – Client Entries .....	45
Figure 3.4-8	DHCP Server – Port and IP Binding.....	46



Figure 3.4-9	TFTP – Update Firmware .....	47
Figure 3.4-10	TFTP – Restore Configuration.....	48
Figure 3.4-11	TFTP – Backup Configuration.....	49
Figure 3.4-12	Syslog Configuration .....	50
Figure 3.4-13	SMTP Configuration.....	51
Figure 3.4-14	Event Configuration.....	52
Figure 3.4-15	Fault Relay Alarm.....	53
Table 3.18:	UTC Timezone .....	54
Figure 3.4-16	SNTP Configuration .....	55
Figure 3.4-17	IP Security.....	56
Figure 3.4-18	User Authentication .....	57
<b>3.3.2</b>	<b>Port.....</b>	<b>58</b>
Figure 3.4-19	Port Statistics .....	58
Figure 3.4-20	Port Control.....	59
Figure 3.4-21	Aggregator Setting.....	60
Figure 3.4-22	2 work ports with LACP disabled.....	61
Figure 3.4-23	Static trunking group of 2 ports .....	61
Figure 3.4-24	Aggregator Information .....	62
Figure 3.4-25	State Activity .....	63
Figure 3.4-26	Port Mirroring .....	64
Figure 3.4-27	Rate Limiting .....	65
<b>3.3.3</b>	<b>Protocol .....</b>	<b>66</b>
Figure 3.4-28	VLAN Configuration .....	66
Figure 3.4-29	Port based mode.....	67
Figure 3.4-30	Port based mode-Add interface.....	68
Figure 3.4-31	Port Based Edit/Delete interface.....	69
Figure 3.4-32	802.1Q VLAN Configuration .....	71
Figure 3.4-33	Edit Group Configuration interface .....	72
Figure 3.4-34	802.1Q Group Configuration-Edit.....	72
Figure 3.4-35	RSTP System Configuration interface.....	73
Figure 3.4-36	RSTP Port Configuration interface.....	74
Figure 3.4-37	SNMP System Configuration interface .....	75
Figure 3.4-38	Trap Configuration interface.....	76
Figure 3.4-39	SNMP V3 Configuration interface .....	78
Figure 3.4-40	QoS Configuration interface .....	80
Table 3.19:	IGMP types.....	81
Figure 3.4-41	IGMP Configuration interface .....	81
Figure 3.4-42	X-ring interface .....	83
<b>3.3.4</b>	<b>Security.....</b>	<b>84</b>
Figure 3.4-43	802.1x/Radius System Configuration.....	84
Figure 3.4-44	802.1x/Radius - Port Setting.....	85
Figure 3.4-45	802.1x/Radius - Misc Configuration.....	86
Figure 3.4-46	Static MAC Addresses interface.....	87
Figure 3.4-47	MAC Filtering interface.....	88
Figure 3.4-48	All MAC Address interface .....	89
Figure 3.4-49	Factory Default interface .....	90
Figure 3.4-50	Save Configuration interface .....	91
Figure 3.4-51	System Reboot interface .....	92

## **Chapter 4    Troubleshooting ..... 94**

<b>Appendix A</b>	<b>Pin Assignments &amp; Wiring</b>	<b>96</b>
	Figure A.1: RJ-45 Pin Assignments.....	96
	Figure A.2: EIA/TIA-568B.....	96
	Figure A.3: EIA/TIA-568A .....	96
	Figure A.4: DB 9-pin female connector .....	97
<b>Appendix B</b>	<b>Compatible SFP Transceivers</b>	<b>100</b>





## Overview

Sections include:

- Introduction
- Features
- Specifications
- Packing List
- Safety Precaution

# Chapter 1 Overview

## 1.1 Introduction

---

To create reliability in your network, the EKI-7758F comes equipped with a proprietary redundant network protocol—X-Ring that was developed by Advantech, which provides users with an easy way to establish a redundant Ethernet network with ultra high-speed recovery time less than 10 ms.

Aside from 4 x 10/100/1000Base-T(X) fast Ethernet ports, the EKI-7758F come equipped with 4 SFP (mini-GBIC) fiber optic ports. Traditional RJ-45 ports can be used for uplinking wide-band paths in short distance (< 100 m), while the SFP slots can be used for the application of wideband uploading and long distance transmissions to fit the field request flexibility. Also, the long MTBF (Mean Time Between Failures) ensures that the EKI-7758F will continue to operate until a Gigabit network infrastructure has been established, without requiring any extra upgrade costs.

### 1.1.1 The SFP Advantage

The SFP fiber slots provide a lot of flexibility when users are planning and implementing a network. The slots can accept any SFP-type fiber transceivers designed for transmitting over distances of either 500m (multi-mode), 10km, 30km, 50km, 70km or 110km (single-mode) – and the slots support SFP transceivers for WDM single-fiber transmissions. This means that you can easily change the transmission mode and distance of the switch by simply pulling out the SFP transceiver and plugging in a different one. The SFP slots are hot-swappable and plug-and-play! Also, the fact that the switch has four of these slots, means that the network manager can, for example, have one 10km transceiver in one slot and one 110km in the other.

### 1.1.2 High-Speed Transmissions

The EKI-7758F includes a switch controller that can automatically sense transmission speeds (10/100 Mbps). The RJ-45 interface can also be auto-detected, so MDI or MDI-X is automatically selected and a crossover cable is not required. All Ethernet ports have memory buffers that support the store-and-forward mechanism. This assures that data is properly transmitted.

### 1.1.3 Dual Power Inputs

To reduce the risk of power failure, the EKI-7758C provides +12 ~ 48 V<sub>DC</sub> dual power inputs. When one of the power inputs fails, P-Fail LED will turn on and send an alarm through a relay output for notifying the user; and the switch will toggle to the secondary power input.

### 1.1.4 Flexible Mounting

EKI-7758F is compact and can be mounted on a DIN-rail or panel, so it is suitable for any space-constrained environments.

### **1.1.5 Wide Operating Temperature**

The operating temperature of the EKI-7758F is between -10 ~ 60 °C. With such a wide range, you can use the EKI-7758F in some of the harshest industrial environments that exist.

### **1.1.6 Easy Troubleshooting**

LED indicators make troubleshooting quick and easy. Each 10/100/1000 Base-TX port has 2 LEDs that display the link status, transmission speed and collision status. Also the three system LED indicators P1, P2 and P-Fail help you diagnose immediately.

## 1.2 Features

---

- All Gigabit Ethernet ports for 4 Copper and 4 SFP
- SFP sockets for easy and flexible fiber expansion
- Redundancy: Gigabit X-Ring (ultra high-speed recovery time < 10ms), RSTP/STP (802.1w/1D)
- Management: Web, Telnet, Serial Console, Windows Utility, SNMP
- Control: VLAN/GVRP, QoS, IGMP Snooping, LACP, Rate Limit
- Security: IP/MAC and port binding, DHCP Server, IP access list, 802.1x, SNMPv3
- Diagnostic: Port statistic, Port Mirroring, RMON, Trap, SMTP Alert, Syslog
- Dual 12 ~ 48 V<sub>DC</sub> power input and 1 Relay Output
- Robust mechanism and special heat spreader design



## 1.3 Specifications

---

### Communications

<b>Standard</b>	IEEE 802.3, 802.3ab, 802.3ad, 802.3u, 802.3x, 802.3z
<b>LAN</b>	IEEE 802.1d, 802.1p, 802.1Q, 802.1w, 802.1X, 10/100/1000Base-TX, Optional 100Base-FX, 1000Base-SX/LX/LHX/XD/ZX/EZX
<b>Transmission Distance</b>	Ethernet: Up to 100m (4-wire Cat.5e, Cat.6 RJ-45 cable suggested for Gigabit ports) SFP: Up to 110km (depends on SFP)
<b>Transmission Speed</b>	Gigabit Copper: 10/100/1000 Mbps, Auto-Negotiation Gigabit Fiber: Up to 1000Mbps

### Interface

<b>Connectors</b>	4 x RJ-45 (Ethernet) 4 x SFP (mini-GBIC) ports 6-pin removable screw terminal (Power & Relay)
<b>LED Indicators</b>	System: PWR, R.M., PWR1, PWR2, P-Fail Gigabit Copper: Link/Activity, Speed (1000Mbps) SFP: Link/Activity
<b>Console</b>	RS-232 (RJ-45)

### Network Management

<b>Configuration</b>	Web browser, Telnet, Serial Console, Windows Utility, TFTP, SNMP v1/v2c/v3, Port Speed/Duplex Configuration
<b>VLAN</b>	IEEE 802.1Q, GVRP, Port-based, VLAN
<b>Redundancy</b>	ADVANTECH X-Ring (Recovery time < 10ms at 30pcs full loading ring structure), Dual Homing, Couple Ring, 802.1w/D RSTP/STP
<b>Security</b>	IP Access security, port security, DHCP Server, Port and IP Binding, 802.1X Port Access Control
<b>Traffic Control</b>	IGMP Snooping/Query for multicast group management, Port Trunking, Static/802.3ad LACP Rate limit and storm control IEEE 802.1p QoS Cos/TOS/DSCP priority queuing IEEE 802.3x flow control
<b>Diagnostics</b>	Port Mirroring, Real-time traffic statistic, MAC Address Table, SNTP, Syslog, E-Mail Alert, SNMP, Trap, RMON

## Power

**Power Consumption**  
**Power Input**  
**Fault Output**

Max. 14.44 W  
2 x Unregulated +12 ~ 48 V<sub>DC</sub>  
1 Relay Output

## Mechanism

**Dimensions (WxHxD)**  
**Enclosure**  
**Mounting**

79 x 152 x 105 mm  
IP30, metal shell with solid mounting kits  
DIN-rail, wall

## Protection

**Power Reverse**  
**Overload**

Present  
3.5A@12VDC (Fuse)

## Environment

**Operating Temperature**  
**Operating Humidity**  
**Storage Temperature**  
**Storage Humidity**  
**MTBF**

-10 ~ 60°C (14 ~ 140°F)  
5 ~ 95% (non-condensing)  
-40 ~ 85°C (-40 ~ 185°F)  
0 ~ 95% (non-condensing)  
289,774 hours

## Certifications

**Safety**  
**EMC**

UL, 60950-1, CAN/CSA-C22.2 No.60950  
U.S.A.: FCC Part 15 CISPR 22  
EU: EN55011, EN61000-6-4  
EN55022, Class A,  
EN61000-3-2/3  
EN55024  
IEC61000-4-2/3/4/5/6/8  
EN61000-6-2  
IEC60068-2-32  
IEC60068-2-27  
IEC60068-2-6

**Freefall**  
**Shock**  
**Vibration**

## 1.4 Packing List

---

- 1 x EKI-7758F Industrial Managed Gigabit Ethernet Switch
- 1 x eAutomation Industrial Communication CD-ROM with software, and User manual
- 2 x Wall Mounting Bracket and Screws
- 1 x DIN-rail Mounting Bracket and Screws
- 1 x 8-pin RJ-45 to RS-232 serial cable
- 1 x DC Jack Cable  $\phi$  2.0/150mm
- 1 x EKI-7758F Startup Manual

## 1.5 Safety Precaution

---

*Attention*    *IF DC voltage is supplied by an external circuit, please use a protection device on the power supply input.*



## **Installation**

Sections include:

- LED Indicators
- Dimensions
- Mounting
- Network Connection
- Connection to a Fiber Optic Network
- Power Connection
- X-Ring Application
- Couple Ring Application
- Dual Homing Application

## Chapter 2 Installation

In this chapter, you will be given an overview of the EKI-7758F hardware installation procedures.

### 2.1 LED Indicators

There are few LEDs located on the front panel display the power status and network status of EKI-7758F. Each of them has its own specific meaning shown as below.

<i>Table 2.1: EKI-7758F LED Definition</i>			
LED	Color	Description	
PWR	Green	On	System power on
		Off	No power input
R.M.	Green	On	The industrial switch is the master of the X-ring group
		Off	The industrial switch is not the master of the X-ring group
PWR1	Green	On	Power input 1 is active
		Off	Power input 1 is inactive
PWR2	Green	On	Power input 2 is active
		Off	Power input 2 is inactive
P-Fail	Red	On	Power input 1 or 2 is inactive or port link down (depends on Fault Relay Alarm configuration)
		Off	Power input 1 and 2 are both active, or no power input
Link/Active (G5 ~ G8)	Green	On	SFP port is linking
		Flashing	Data is transmitting or receiving
		Off	Not connected to network
G1 ~ G4	Green (Upper LED)	On	Connected to network
		Flashing	Networking is active
		Off	Not connected to network
	Green (Lower LED)	On	The port is operating at speed of 1000M
		Off	The port is disconnected or not operating at speed of 1000M

## 2.2 Dimensions (units: mm)

---

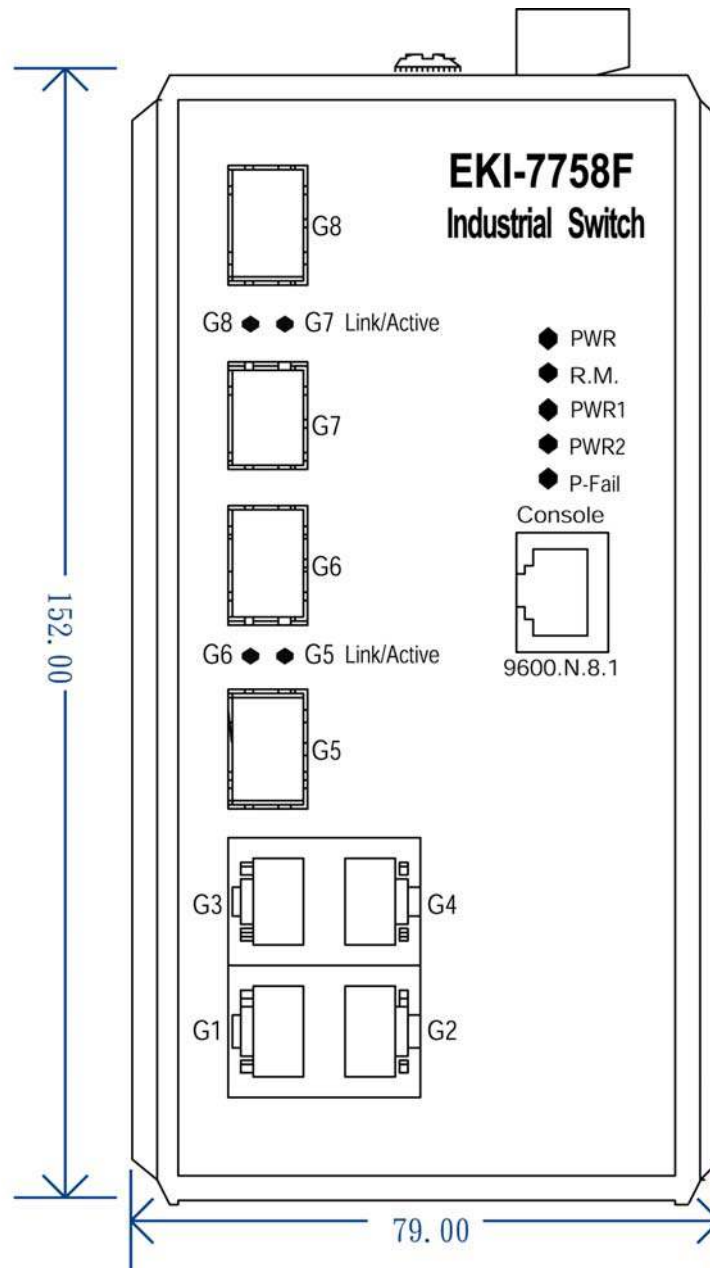

Figure 2.2-1 Front View of EKI-7758F

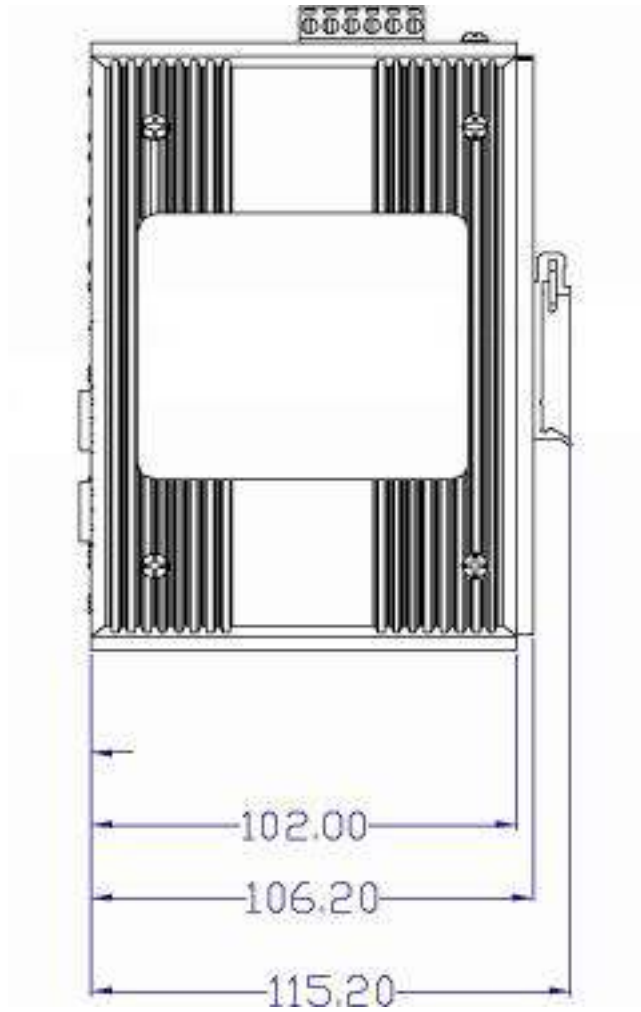

Figure 2.2-2 Side View of EKI-7758F



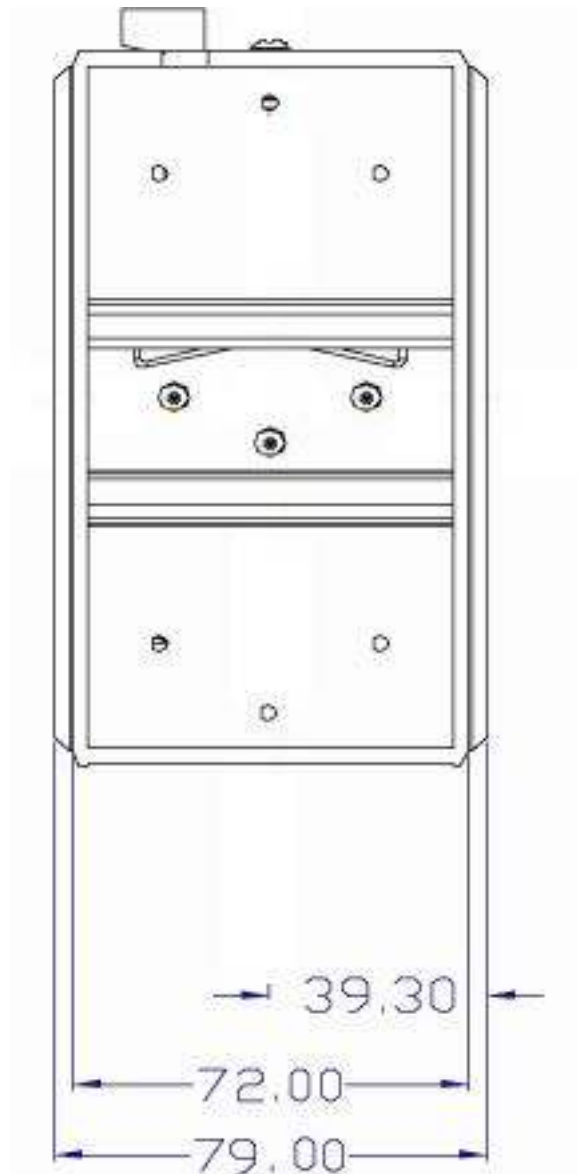

Figure 2.2-3 Rear View of EKI-7758F

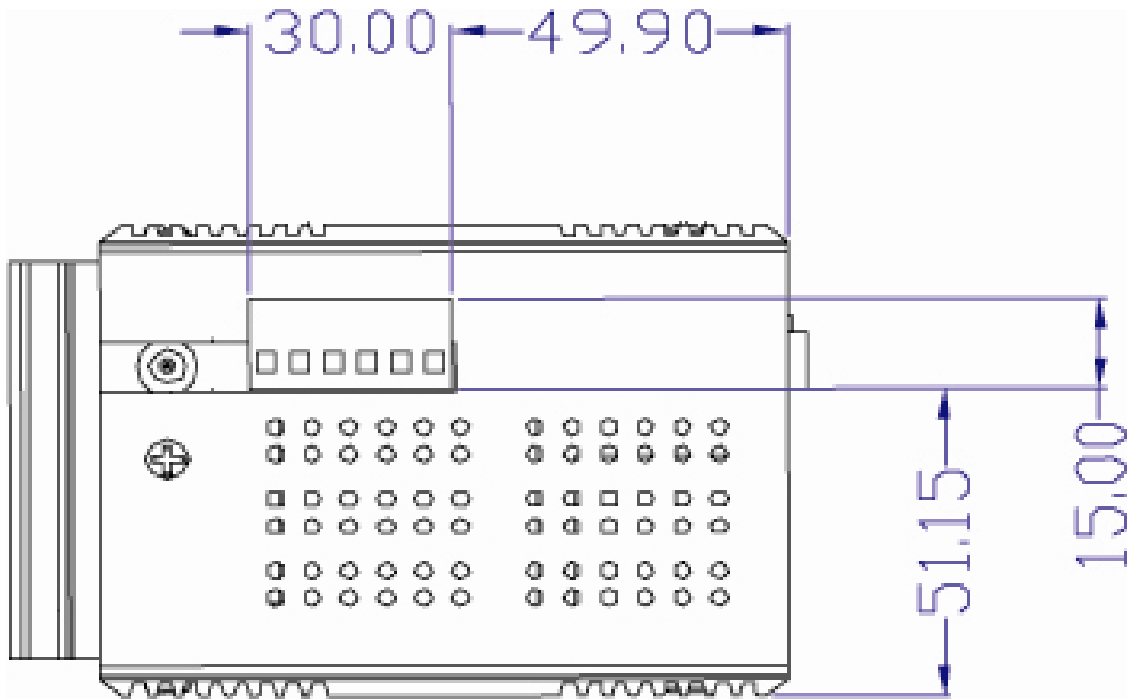

Figure 2.2-4 Top View of EKI-7758F

## 2.3 Mounting

The EKI-7758F supports two mounting methods: DIN-rail & Wall.

### 2.3.1 Wall mounting

EKI-7758F can be wall-mounted by using the included mounting kit. Then, hang on the EKI-7758F to the nails on the wall.

First, use the screws included in the package to combine the EKI-7758F and metal mounting kit. And then you can install the device firmly via the components, please see the figure below.

EKI-7xxx

Unit: mm

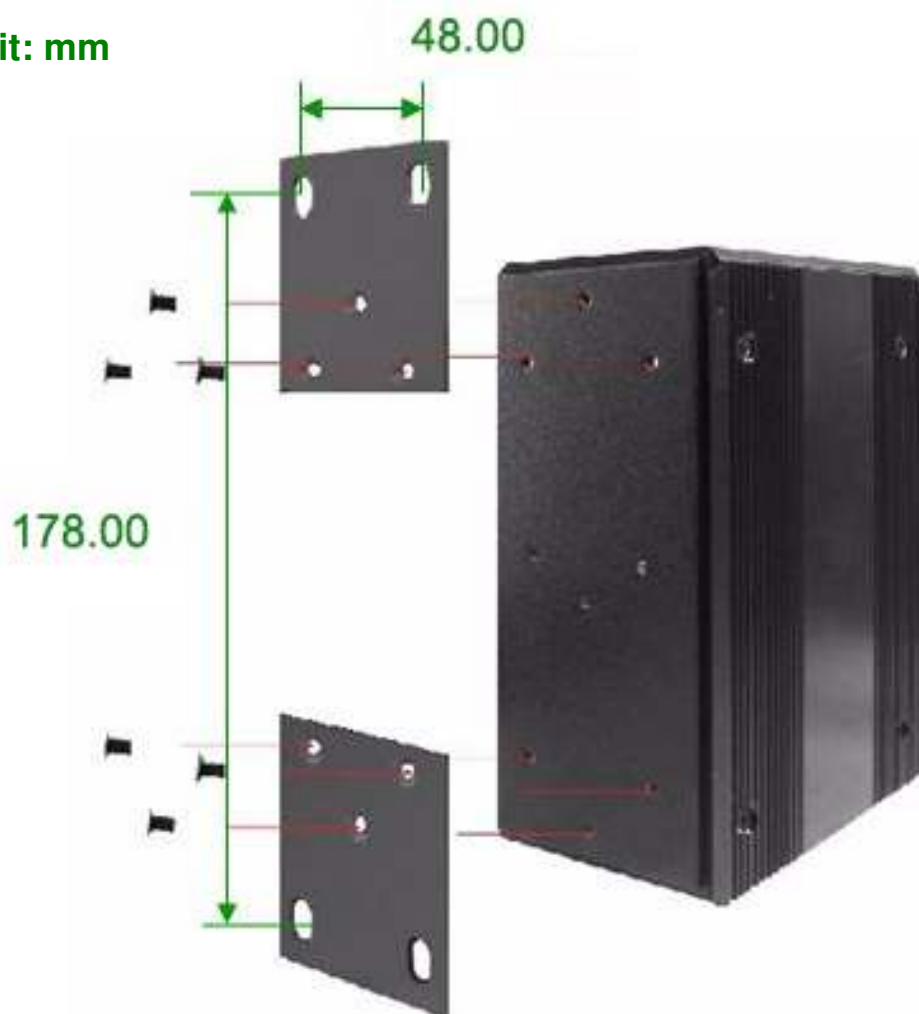

Figure 2.3-1 Combine the Metal Mounting Kit

### 2.3.2 DIN-rail Mounting

You can also mount EKI-7758F on a standard DIN-rail by steps below.

The DIN-rail kit is screwed on the industrial switch when out of factory. If the DIN-rail kit is not screwed on the industrial switch, please screw the DIN-rail kit on the switch first.

First, hang the EKI-7758F to the DIN-rail with angle of inclination. See Figure 2.6.



*Figure 2.3-2 Installation to DIN-rail Step 1*

Then, hook the device over the DIN rail and let it drop down straight to slide over the rail smoothly.



*Figure 2.3-3 Installation to DIN-rail Step 2*

## 2.4 Network Connection

---

The EKI-7758F has 4 x RJ-45 ports that support connection to 10 Mbps Ethernet, 100 Mbps Fast Ethernet or 1000 Mbps Gigabit Ethernet. EKI-7758F can be connected to other hubs or switches via a twisted-pair straight-through or crossover cable up to 100m long. The connection can be made from any TX port of the EKI-7758F (MDI-X) to another hub or switch either MDI-X or uplink MDI port.

The EKI-7758F supports auto-crossover to make networking more easy and flexible. You can connect any RJ-45 (MDI-X) station port on the switch to any device such as a switch, bridge or router.

## 2.5 Connection to a Fiber Optic Network

---

EKI-7758F has 4 SFP slots for connecting to the network segment with single or multi-mode fiber. You can choose the appropriate mini-GBIC transceiver to plug into the slot. Make sure the transceiver is aligned correctly and then slide it into the SFP slot until a click is heard. You can use proper multi-mode or single-mode fiber according to the connected SFP transceiver. With fiber optic, it transmits speed up to 1000 Mbps and you can prevent noise interference from the system and transmission distance up to 110 km, depending on the mini-GBIC transceiver.

The small form-factor pluggable (SFP) is a compact optical transceiver used in optical communications for both telecommunication and data communications applications.

**Note** *The SFP/Copper Combo port can't be used at the same time. The SFP port has the higher priority than copper port; if you insert the 1000M SFP transceiver into the SFP port which is connected to the remote device, the connection of the accompanying copper port will link down.  
If you insert the 100M SFP transceiver into the SFP port even without a fiber connection to the remote, the connection of the accompanying copper port will link down immediately.*

To connect the transceiver and LC cable, please follow the steps shown below:

First, insert the transceiver into the SFP slot. Note that the location of the triangle indicates the bottom of the slot.

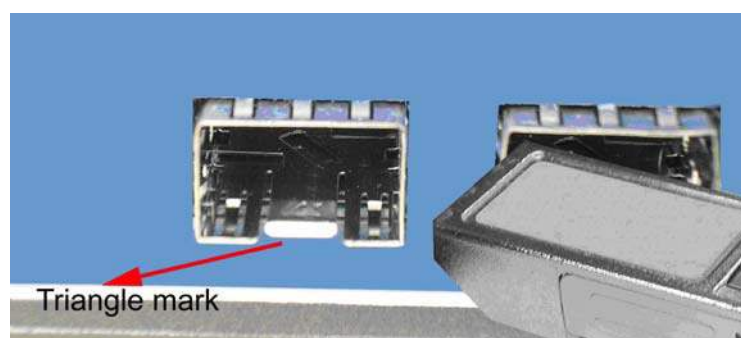
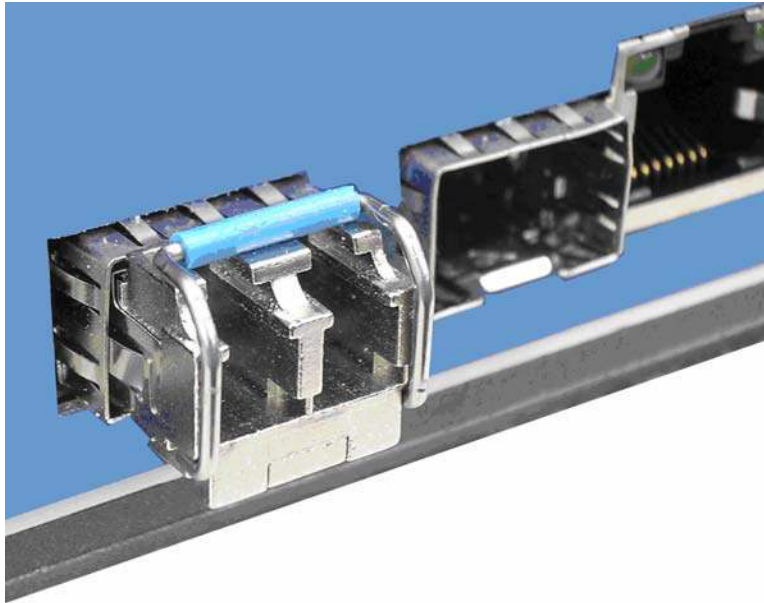
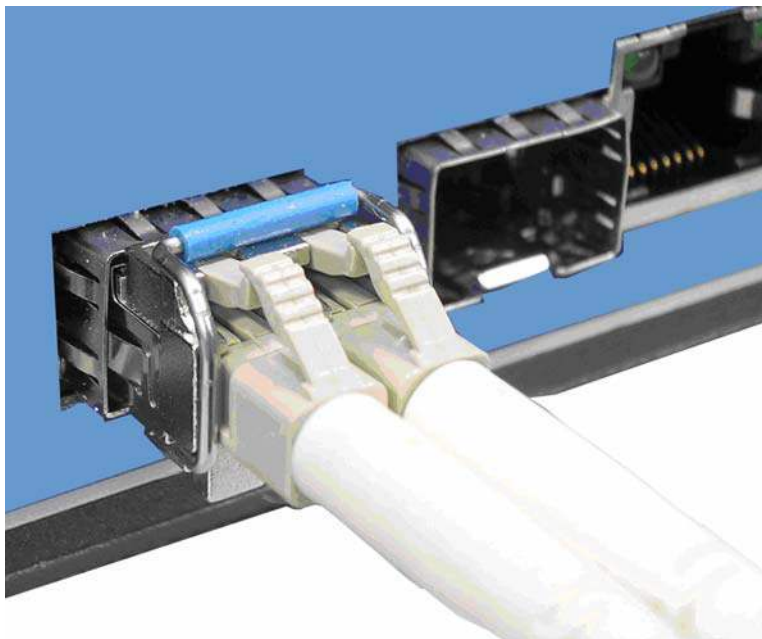

Figure 2.5-1 Transceiver to the SFP slot



*Figure 2.5-2 Transceiver Inserted*

Second, insert the fiber cable of LC connector into the transceiver.



*Figure 2.5-3 LC connector to the transceiver*

To remove the LC connector from the transceiver, please follow the steps shown below:  
First, press the upper side of the LC connector to release from the transceiver and pull it out.

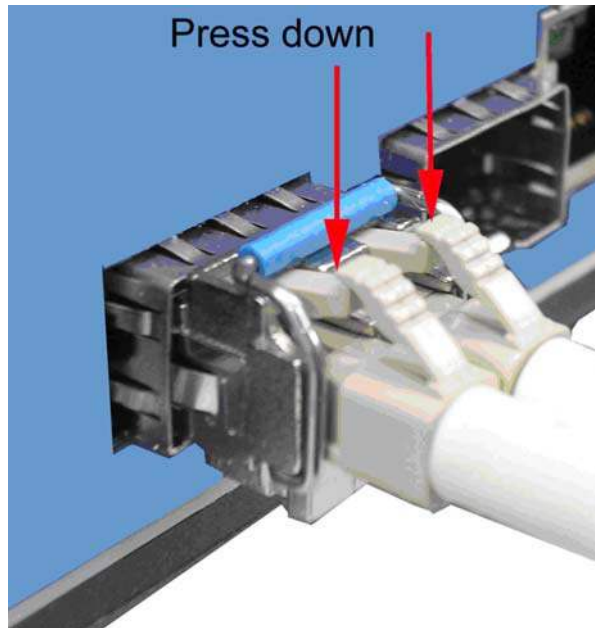

*Figure 2.5-4 Remove LC connector*

Second, push down the metal loop and pull the transceiver out by the plastic handle.

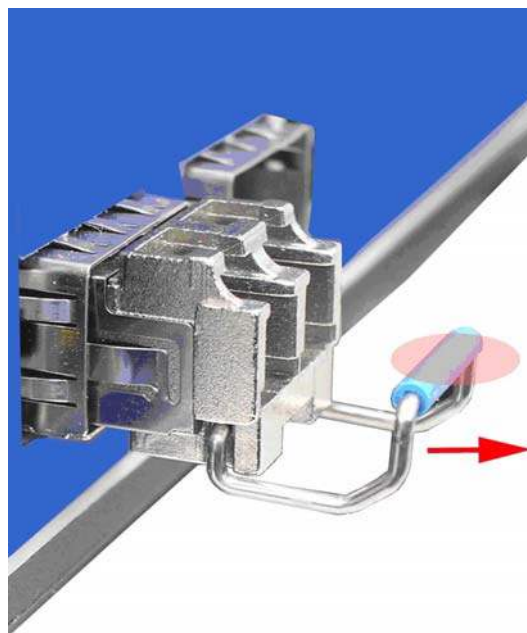

*Figure 2.5-5 Pull out from the transceiver*



## 2.6 Power Connection

---

The EKI-7758F supports dual +12 ~ 48 V<sub>DC</sub> power inputs and power-fail relay output.

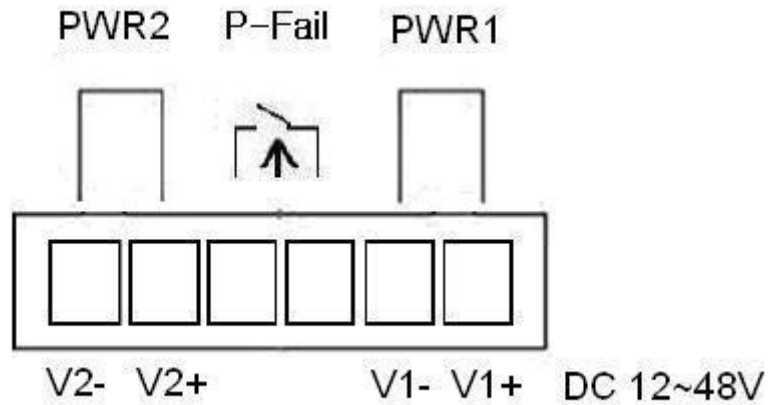
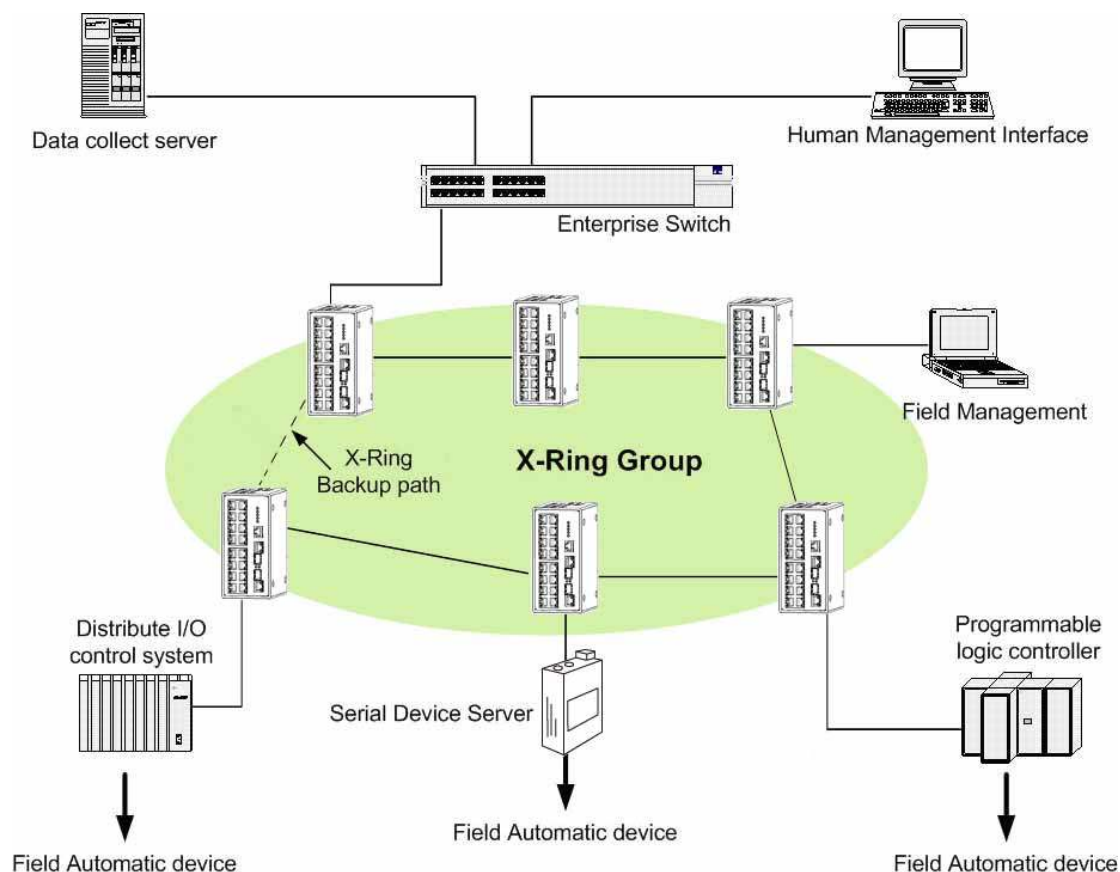

Figure 2.6-1 Pinouts of the Power Connector

You can connect an alarm indicator, buzzer or other signaling equipment through the relay output. The relay opens if power input 1, 2 fails or port link down/break ("Open" means if you connect relay output with an LED, the light would be off).

## 2.7 X-Ring Application

The industrial switch supports the X-Ring protocol that can help the network system recover from network connection failure within 10ms or less and make the network system more reliable. The X-Ring algorithm is similar to Spanning Tree Protocol (STP) and Rapid STP (RSTP) algorithm but its recovery time is less than STP/RSTP. The figure below is a sample of X-Ring application.



*Note* The Ethernet switches with firmware version before v3.0 use the **X-Ring** function that has the limitation as follows. However, the one with firmware version after v3.0 (included) use the **X-Ring Pro** function that gets rid of the limitation.

1. The X-Ring is supposed to recover from connection failure within 10ms when the amount of the connected devices of the X-Ring group is less than 50.

## 2.8 Coupling Ring Application

As the illustration shown below, users can use the X-Ring groups to form a coupling ring for redundant backup. It can ensure the transmissions between X-Ring groups not to fail. The following figure is a sample of coupling ring application.

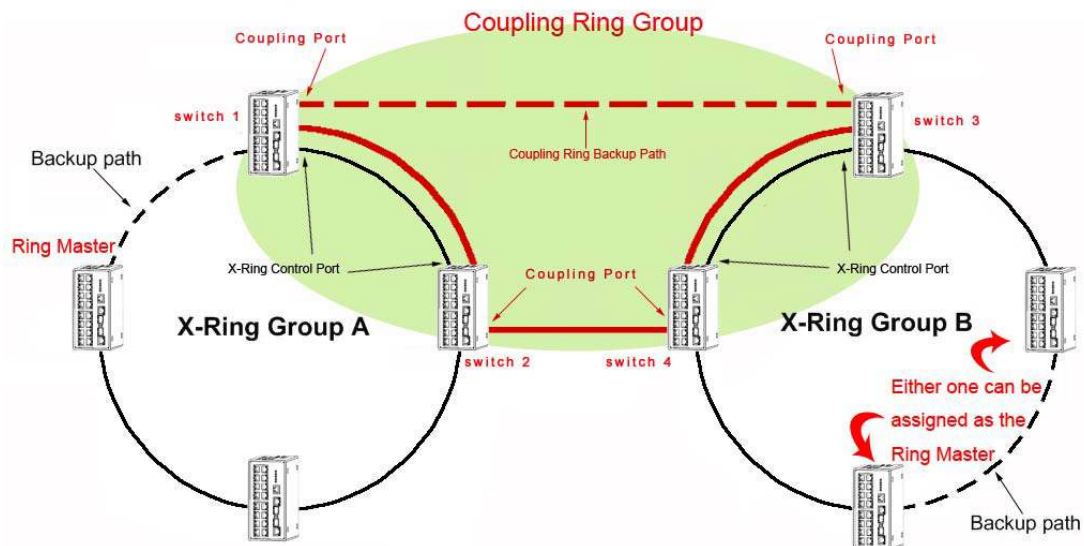

**Note** The Ethernet switches with firmware version before v3.0 use the **X-Ring** function that has the limitations as follows. However, the ones with firmware version after v3.0 (included) use the **X-Ring Pro** function that gets rid of the limitations.

1. To ensure the coupling ring to work normally, the connection between control ports of each X-ring group, as the figure illustrated above, should always be active.
2. The switches to be configured as members of the Coupling Ring group cannot be the X-Ring Master device of their X-ring group.
3. As the figure illustrated above, Coupling Ring only supports two X-ring groups.

## 2.9 Dual Homing Application

The Dual Homing function is to prevent the connection loss between the particular X-Ring group and the upper level/core switch. Assign one port, and only one, to be the Dual Homing port that is the backup port in each single X-Ring group. The Dual Homing function only works when the X-Ring function is active.

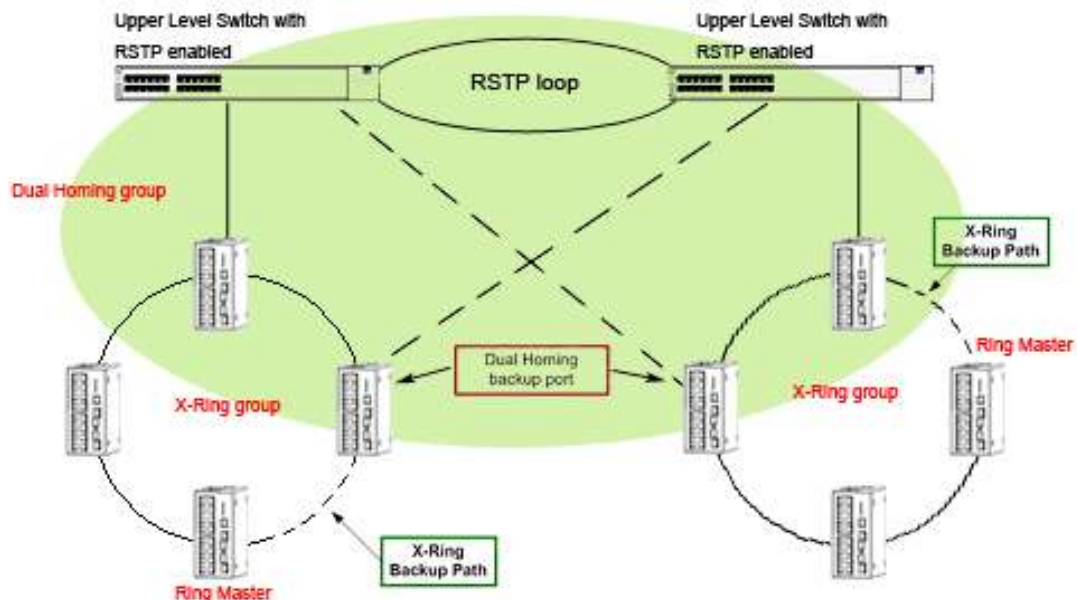

*Note* The Ethernet switches with firmware version before v3.0 use the **X-Ring** function that has the limitations as follows. However, the ones with firmware version after v3.0 (included) use the **X-Ring Pro** function that gets rid of the limitations.

1. In Dual Homing application architecture, the upper level switches need to enable their Rapid Spanning Tree protocol.
2. The switches to be configured as members of the Dual Homing group cannot be the X-Ring Master device of their X-ring group.
3. As the figure illustrated above, Dual Homing only supports two X-ring groups.

## Configuration

Sections include:

- RS-232 Console
- Commands Set
- Web Browser

# Chapter 3 Configuration

The EKI-7758F can be configured via RS-232 Console or a web browser.

## 3.1 RS-232 Console

EKI-7758F's RS-232 console is designed for rapidly configuring which provides the console management – CLI command.

Attach the supplied cable, which one end is RJ-45 and the other end is female DB9, to connect EKI-7758F and your host PC or terminal. The connected PC or terminal must support the terminal emulation program.

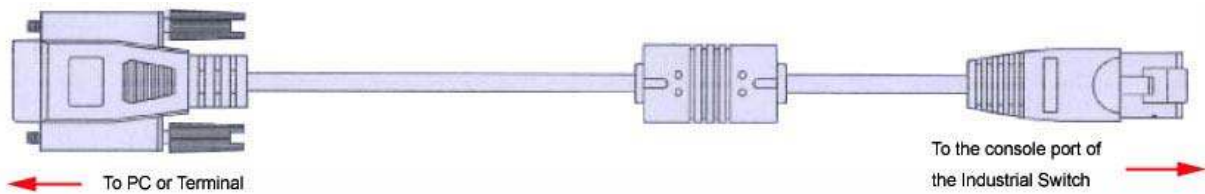

Figure 3.1-1 Console Cable

From the Windows desktop, click **Start/Programs/Accessories/Communications/HyperTerminal** to open the Hyper Terminal program.

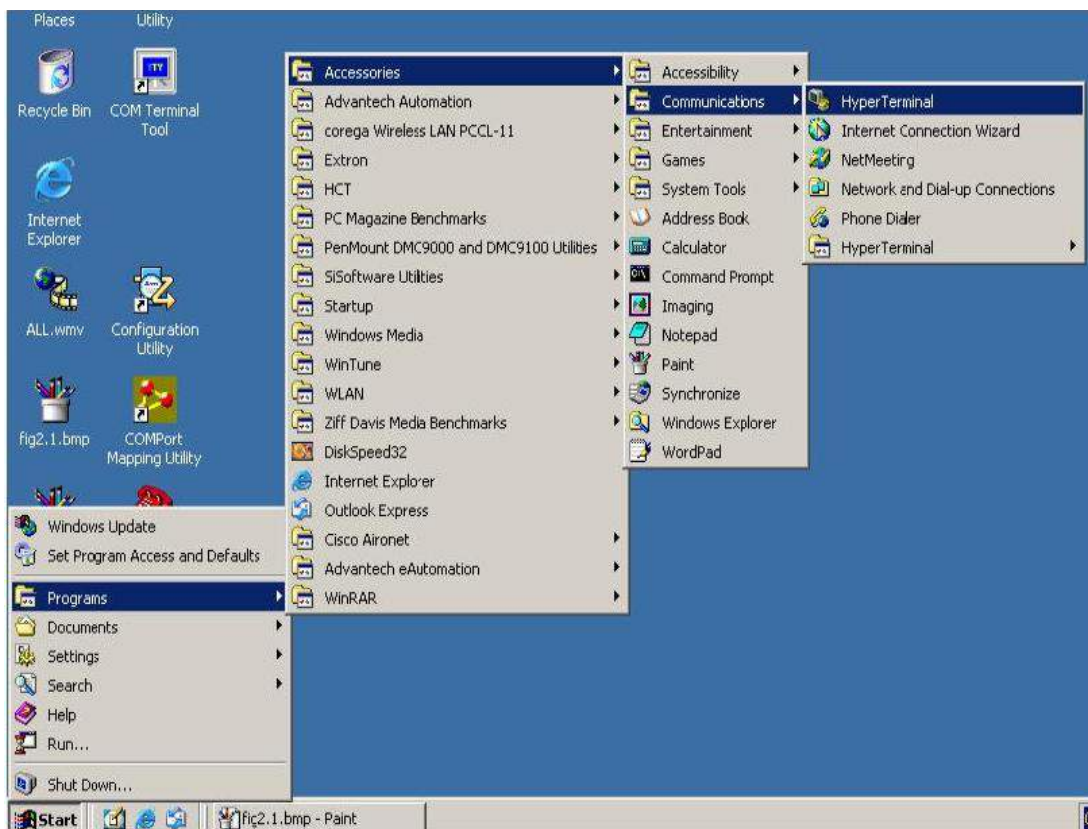

Figure 3.1-2 Launching Hyper Terminal

Select the appropriate COM port, and set the parameter as the figure shown below (**9600** for **Baud Rate**, **8** for **Data Bits**, **None** for **Parity**, **1** for **Stop Bits**, and **None** for **Flow Control**).

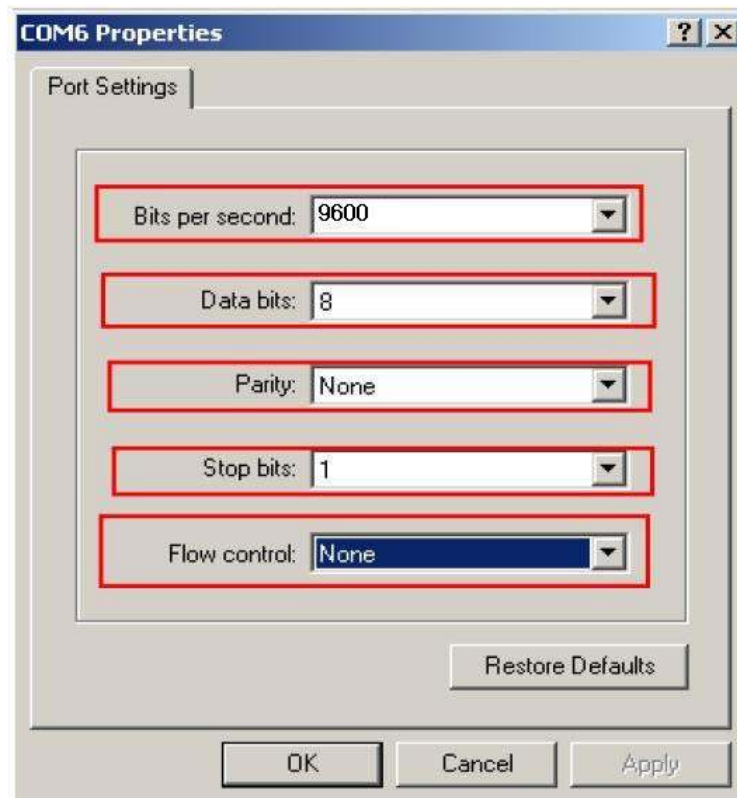

Figure 3.1-3 COM Port Properties Setting

Press **Enter** for login screen (If you can not find the login screen, press **Enter** one more time). The default user name and password are both "**admin**". Key-in the user name and password to enter the command line interface.

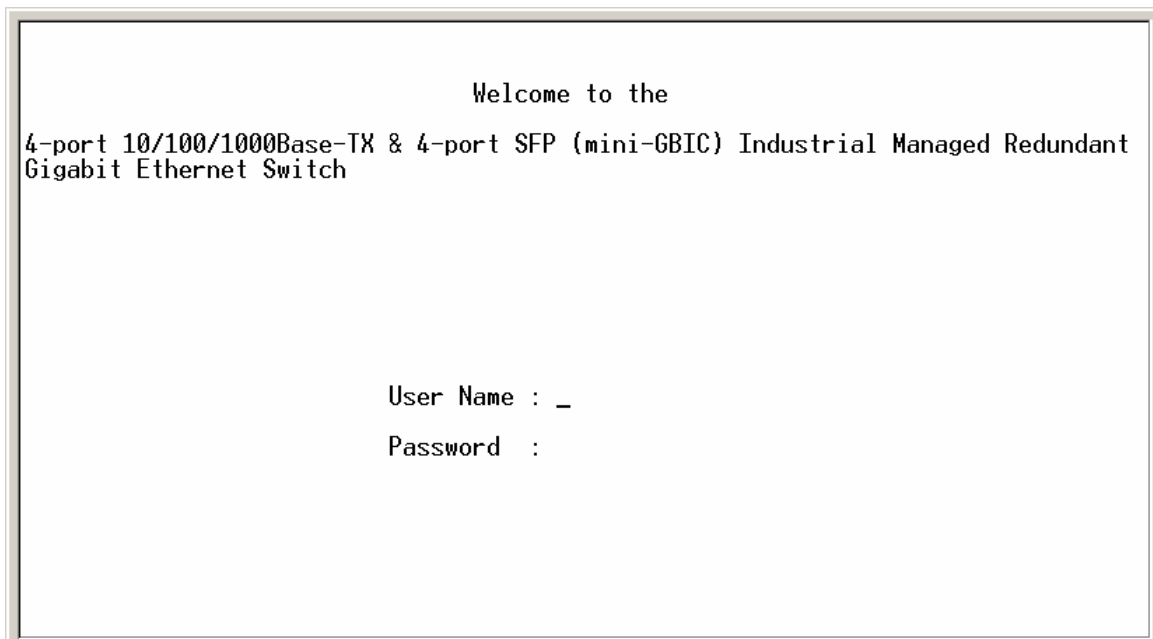

Figure 3.1-4 Login Screen: RS-232 Configuration

After you have logged in to the system, you will see a command prompt. To enter CLI management interface, type in “**enable**” command.

```
switch>enable  
switch#_
```

*Figure 3.1-5 Command Line Interface*



## 3.2 Commands Set

The following table lists the CLI commands and description.

### 3.2.1 Commands Level

*Table 3.1: Command Level*

Modes	Access Method	Prompt	Exit Method	About This Model
User EXEC	Begin a session with your switch.	switch>	Enter <b>logout</b> or <b>quit</b> .	The user commands available at the user level are a subset of those available at the privileged level. Use this mode to <ul style="list-style-type: none"> <li>• Perform basic tests.</li> <li>• Display system information.</li> </ul>
Privileged EXEC	Enter the <b>enable</b> command while in user EXEC mode.	switch#	Enter <b>disable</b> to exit.	The privileged commands are the advanced mode. Use this mode to <ul style="list-style-type: none"> <li>• Display advanced function status</li> <li>• Save configuration</li> </ul>
Global Configuration	Enter the <b>configure</b> command while in privileged EXEC mode.	switch(config)#	To exit to the Privileged EXEC mode, enter <b>exit</b> or <b>end</b>	Use this mode to configure the parameters to be applied to your switch
VLAN database	Enter the <b>vlan database</b> command while in privileged EXEC mode.	switch(vlan)#	To return to the User EXEC mode, enter <b>exit</b> .	Use this mode to configure VLAN-specific parameters.
Interface configuration	Enter the <b>interface</b> command with a specific interface while in the Global Configuration mode	switch(config-if)#	To return to the previous mode, enter <b>exit</b> or <b>end</b> .	Use this mode to configure the parameters for the switch and Ethernet ports.

### 3.2.2 Commands Set List

*Table 3.2: Commands Set List*

Command	Code Word
User EXEC	E
Privileged EXEC	P
Global configuration	G
VLAN database	V
Interface configuration	I

### 3.2.3 System Commands Set

Table 3.3: System Commands Set			
Commands	Level	Description	Example
<b>show config</b>	<b>E</b>	Show switch configuration	switch> <b>show config</b>
<b>show terminal</b>	<b>P</b>	Show console information	switch# <b>show terminal</b>
<b>write memory</b>	<b>P</b>	Save user configuration into permanent memory (flash rom)	switch# <b>write memory</b>
<b>system name</b> [System Name]	<b>G</b>	Configure system name	switch(config)# <b>system name xxx</b>
<b>system location</b> [System Location]	<b>G</b>	Set switch system location string	switch(config)# <b>system location xxx</b>
<b>system description</b> [System Description]	<b>G</b>	Set switch system description string	switch(config)# <b>system description xxx</b>
<b>system contact</b> [System Contact]	<b>G</b>	Set switch system contact window string	switch(config)# <b>system contact xxx</b>
<b>show system-info</b>	<b>E</b>	Show system information	switch> <b>show system-info</b>
<b>ip address</b> [Ip-address] [Subnet-mask] [Gateway]	<b>G</b>	Configure the IP address of switch	switch(config)# <b>ip address 192.168.1.1 255.255.255.0 192.168.1.254</b>
<b>ip dhcp</b>	<b>G</b>	Enable DHCP client function of switch	switch(config)# <b>ip dhcp</b>
<b>show ip</b>	<b>P</b>	Show IP information of switch	switch# <b>show ip</b>
<b>no ip dhcp</b>	<b>G</b>	Disable DHCP client function of switch	switch(config)# <b>no ip dhcp</b>
<b>reload</b>	<b>G</b>	Halt and perform a cold restart	switch(config)# <b>reload</b>
<b>default</b>	<b>G</b>	Restore to default	switch(config)# <b>default</b>
<b>admin username</b> [Username]	<b>G</b>	Changes a login username. (maximum 10 words)	switch(config)# <b>admin username xxxxxx</b>
<b>admin password</b> [Password]	<b>G</b>	Specifies a password (maximum 10 words)	switch(config)# <b>admin password xxxxxx</b>
<b>show admin</b>	<b>P</b>	Show administrator information	switch# <b>show admin</b>
<b>dhcpserver enable</b>	<b>G</b>	Enable DHCP Server	switch(config)# <b>dhcpserver enable</b>
<b>Dhcpserver disable</b>	<b>G</b>	Disable DHCP Server	switch(config)# <b>no dhcpserver</b>
<b>dhcpserver lowip</b> [Low IP]	<b>G</b>	Configure low IP address for IP pool	switch(config)# <b>dhcpserver lowip 192.168.1.100</b>
<b>dhcpserver highip</b> [High IP]	<b>G</b>	Configure high IP address for IP pool	switch(config)# <b>dhcpserver highip 192.168.1.200</b>
<b>dhcpserver subnetmask</b> [Subnet mask]	<b>G</b>	Configure subnet mask for DHCP clients	switch(config)# <b>dhcpserver subnetmask 255.255.255.0</b>
<b>dhcpserver gateway</b> [Gateway]	<b>G</b>	Configure gateway for DHCP clients	switch(config)# <b>dhcpserver gateway 192.168.1.254</b>
<b>dhcpserver dnsip</b> [DNS IP]	<b>G</b>	Configure DNS IP for DHCP clients	switch(config)# <b>dhcpserver dnsip 192.168.1.1</b>
<b>dhcpserver leasetime</b> [Hours]	<b>G</b>	Configure lease time (in hour)	switch(config)# <b>dhcpserver leasetime 1</b>
<b>dhcpserver ipbinding</b> [IP address]	<b>I</b>	Set static IP for DHCP clients by port	switch(config)# <b>interface fastEthernet 2</b> switch(config)# <b>dhcpserver ipbinding 192.168.1.1</b>
<b>show dhcpserver configuration</b>	<b>P</b>	Show configuration of DHCP server	switch# <b>show dhcpserver configuration</b>
<b>show dhcpserver clients</b>	<b>P</b>	Show client entries of DHCP server	switch# <b>show dhcpserver clients</b>
<b>show dhcpserver ip-binding</b>	<b>P</b>	Show IP-Binding information of DHCP server	switch# <b>show dhcpserver ip-binding</b>
<b>no dhcpserver</b>	<b>G</b>	Disable DHCP server function	switch(config)# <b>no dhcpserver</b>
<b>security enable</b>	<b>G</b>	Enable IP security function	switch(config)# <b>security enable</b>
<b>security http</b>	<b>G</b>	Enable IP security of HTTP server	switch(config)# <b>security http</b>
<b>security telnet</b>	<b>G</b>	Enable IP security of telnet server	switch(config)# <b>security telnet</b>
<b>security ip</b> [Index(1..10)] [IP Address]	<b>G</b>	Set the IP security list	switch(config)# <b>security ip 1 192.168.1.55</b>
<b>show security</b>	<b>P</b>	Show the information of IP security	switch# <b>show security</b>

<b>no security</b>	<b>G</b>	Disable IP security function	switch(config)# <b>no security</b>
<b>no security http</b>	<b>G</b>	Disable IP security of HTTP server	switch(config)# <b>no security http</b>
<b>no security telnet</b>	<b>G</b>	Disable IP security of telnet server	switch(config)# <b>no security telnet</b>

### 3.2.4 Port Commands Set

Table 3.4: Port Commands Set			
Commands	Level	Description	Example
<b>interface fastEthernet</b> [Portid]	<b>G</b>	Choose the port for modification.	switch(config)# <b>interface fastEthernet 2</b>
<b>duplex</b> [full   half]	<b>I</b>	Use the <b>duplex</b> configuration command to specify the duplex mode of operation for Fast Ethernet.	switch(config)# <b>interface fastEthernet 2</b> switch(config-if)# <b>duplex full</b>
<b>speed</b> [10 100 1000 auto]	<b>I</b>	Use the <b>speed</b> configuration command to specify the speed mode of operation for Fast Ethernet., the speed can't be set to 1000 if the port isn't a giga port..	switch(config)# <b>interface fastEthernet 2</b> switch(config-if)# <b>speed 100</b>
<b>no flowcontrol</b>	<b>I</b>	Disable flow control of interface	switch(config-if)# <b>no flowcontrol</b>
<b>security enable</b>	<b>I</b>	Enable security of interface	switch(config)# <b>interface fastEthernet 2</b> switch(config-if)# <b>security enable</b>
<b>no security</b>	<b>I</b>	Disable security of interface	switch(config)# <b>interface fastEthernet 2</b> switch(config-if)# <b>no security</b>
<b>bandwidth type all</b>	<b>I</b>	Set interface ingress limit frame type to "accept all frame"	switch(config)# <b>interface fastEthernet 2</b> switch(config-if)# <b>bandwidth type all</b>
<b>bandwidth type broadcast-multicast-flooded-unicast</b>	<b>I</b>	Set interface ingress limit frame type to "accept broadcast, multicast, and flooded unicast frame"	switch(config)# <b>interface fastEthernet 2</b> switch(config-if)# <b>bandwidth type broadcast-multicast-flooded-unicast</b>
<b>bandwidth type broadcast-multicast</b>	<b>I</b>	Set interface ingress limit frame type to "accept broadcast and multicast frame"	switch(config)# <b>interface fastEthernet 2</b> switch(config-if)# <b>bandwidth type broadcast-multicast</b>
<b>bandwidth type broadcast-only</b>	<b>I</b>	Set interface ingress limit frame type to "only accept broadcast frame"	switch(config)# <b>interface fastEthernet 2</b> switch(config-if)# <b>bandwidth type broadcast-only</b>
<b>bandwidth in</b> [Value]	<b>I</b>	Set interface input bandwidth. Rate Range is from 100 kbps to 102400 kbps or to 256000 kbps for giga ports, and zero means no limit.	switch(config)# <b>interface fastEthernet 2</b> switch(config-if)# <b>bandwidth in 100</b>
<b>bandwidth out</b> [Value]		Set interface output bandwidth. Rate Range is from 100 kbps to 102400 kbps or to 256000 kbps for giga ports, and zero means no limit.	switch(config)# <b>interface fastEthernet 2</b> switch(config-if)# <b>bandwidth out 100</b>
<b>show bandwidth</b>	<b>I</b>	Show interfaces bandwidth control	switch(config)# <b>interface fastEthernet 2</b> switch(config-if)# <b>show bandwidth</b>
<b>state</b> [Enable   Disable]	<b>I</b>	Use the <b>state</b> interface configuration command to specify the state mode of operation for Ethernet ports. Use the <b>disable</b> form of this command to disable the port.	switch(config)# <b>interface fastEthernet 2</b> switch(config-if)# <b>state Disable</b>

<a href="#">show interface configuration</a>	I	show interface configuration status	switch(config)#interface fastEthernet 2 switch(config-if)#show interface configuration
<a href="#">show interface status</a>	I	show interface actual status	switch(config)#interface fastEthernet 2 switch(config-if)#show interface status
<a href="#">show interface accounting</a>	I	show interface statistic counter	switch(config)#interface fastEthernet 2 switch(config-if)#show interface accounting
<a href="#">no accounting</a>	I	Clear interface accounting information	switch(config)#interface fastEthernet 2 switch(config-if)#no accounting

### 3.2.5 Trunk Commands Set

*Table 3.5: Trunk Commands Set*

Commands	Level	Description	Example
<a href="#">aggregator priority</a> [1~65535]	G	Set port group system priority	switch(config)#aggregator priority 22
<a href="#">aggregator activityport</a> [Group ID] [Port Numbers]	G	Set activity port	switch(config)#aggregator activityport 2
<a href="#">aggregator group</a> [GroupID] [Port-list] <a href="#">lACP</a> <a href="#">workp</a> [Workport]	G	Assign a trunk group with LACP active. [GroupID] :1~3 [Port-list]:Member port list, This parameter could be a port range(ex.1-4) or a port list separate by a comma(ex.2, 3, 6) [Workport]: The amount of work ports, this value could not be less than zero or be large than the amount of member ports.	switch(config)#aggregator group 1 1-4 lACP workp 2 or switch(config)#aggregator group 2 1,4,3 lACP workp 3
<a href="#">aggregator group</a> [GroupID] [Port-list] <a href="#">noLACP</a>	G	Assign a static trunk group. [GroupID] :1~3 [Port-list]:Member port list, This parameter could be a port range(ex.1-4) or a port list separate by a comma(ex.2, 3, 6)	switch(config)#aggregator group 1 2-4 noLACP or switch(config)#aggregator group 1 3,1,2 noLACP
<a href="#">show aggregator</a>	P	Show the information of trunk group	switch#show aggregator 1 or switch#show aggregator 2 or switch#show aggregator 3
<a href="#">no aggregator lACP</a> [GroupID]	G	Disable the LACP function of trunk group	switch(config)#no aggregator lACP 1
<a href="#">no aggregator group</a> [GroupID]	G	Remove a trunk group	switch(config)#no aggregator group 2

### 3.2.6 VLAN Commands Set

*Table 3.6: VLAN Commands Set*

Commands	Level	Description	Example
<a href="#">vlan database</a>	P	Enter VLAN configure mode	switch#vlan database
<a href="#">Vlanmode</a> [portbase] 802.1q   gvrp]	V	To set switch VLAN mode.	switch(vlan)#vlanmode portbase or switch(vlan)#vlanmode 802.1q or switch(vlan)#vlanmode gvrp

<b>no vlan</b>	<b>V</b>	No VLAN	Switch(vlan)#no vlan
<b>Ported based VLAN configuration</b>			
<b>vlan port-based grpname</b> [Group Name] <b>grpname</b> [GroupID] <b>port</b> [PortNumbers]	<b>V</b>	Add new port based VALN	switch(vlan)#vlan port-based grpname test grpname 2 port 2-4 or switch(vlan)#vlan port-based grpname test grpname 2 port 2,3,4
<b>show vlan</b> [GroupID] or <b>show vlan</b>	<b>V</b>	Show VLAN information	switch(vlan)#show vlan 23
<b>no vlan group</b> [GroupID]	<b>V</b>	Delete port base group ID	switch(vlan)#no vlan group 2
<b>IEEE 802.1Q VLAN</b>			
<b>vlan 8021q name</b> [GroupName] <b>vid</b> [VID]	<b>V</b>	Change the name of VLAN group, if the group didn't exist, this command can't be applied.	switch(vlan)#vlan 8021q name test vid 22
<b>vlan 8021q port</b> [PortNumber] <b>access-link untag</b> [UntaggedVID]	<b>V</b>	Assign a access link for VLAN by port, if the port belong to a trunk group, this command can't be applied.	switch(vlan)#vlan 8021q port 3 access-link untag 33
<b>vlan 8021q port</b> [PortNumber] <b>trunk-link tag</b> [TaggedVID List]	<b>V</b>	Assign a trunk link for VLAN by port, if the port belong to a trunk group, this command can't be applied.	switch(vlan)#vlan 8021q port 3 trunk-link tag 2,3,6,99 or switch(vlan)#vlan 8021q port 3 trunk-link tag 3-20
<b>vlan 8021q port</b> [PortNumber] <b>hybrid-link untag</b> [UntaggedVID] <b>tag</b> [TaggedVID List]	<b>V</b>	Assign a hybrid link for VLAN by port, if the port belong to a trunk group, this command can't be applied.	switch(vlan)#vlan 8021q port 3 hybrid-link untag 4 tag 3,6,8 or switch(vlan)#vlan 8021q port 3 hybrid-link untag 5 tag 6-8
<b>vlan 8021q trunk</b> [PortNumber] <b>access-link untag</b> [UntaggedVID]	<b>V</b>	Assign a access link for VLAN by trunk group	switch(vlan)#vlan 8021q trunk 3 access-link untag 33
<b>vlan 8021q trunk</b> [PortNumber] <b>trunk-link tag</b> [TaggedVID List]	<b>V</b>	Assign a trunk link for VLAN by trunk group	switch(vlan)#vlan 8021q trunk 3 trunk-link tag 2,3,6,99 or switch(vlan)#vlan 8021q trunk 3 trunk-link tag 3-20
<b>vlan 8021q trunk</b> [PortNumber] <b>hybrid-link untag</b> [UntaggedVID] <b>tag</b> [TaggedVID List]	<b>V</b>	Assign a hybrid link for VLAN by trunk group	switch(vlan)#vlan 8021q trunk 3 hybrid-link untag 4 tag 3,6,8 or switch(vlan)#vlan 8021q trunk 3 hybrid-link untag 5 tag 6-8
<b>show vlan</b> [GroupID] or <b>show vlan</b>	<b>V</b>	Show VLAN information	switch(vlan)#show vlan 23
<b>no vlan group</b> [GroupID]	<b>V</b>	Delete port base group ID	switch(vlan)#no vlan group 2

### 3.2.7 Spanning Tree Commands Set

<i>Table 3.7: Spanning Tree Commands Set</i>			
Commands	Level	Description	Example
<b>spanning-tree enable</b>	<b>G</b>	Enable spanning tree	switch(config)#spanning-tree enable
<b>spanning-tree priority</b> [0~61440]	<b>G</b>	Configure spanning tree priority parameter	switch(config)#spanning-tree priority 32767
<b>spanning-tree max-age</b> [seconds]	<b>G</b>	Use the spanning-tree max-age global configuration command to	switch(config)#spanning-tree max-age 15

		change the interval between messages the spanning tree receives from the root switch. If a switch does not receive a bridge protocol data unit (BPDU) message from the root switch within this interval, it recomputed the Spanning Tree Protocol (STP) topology.	
<b>spanning-tree hello-time</b> [seconds]	<b>G</b>	Use the spanning-tree hello-time global configuration command to specify the interval between hello bridge protocol data units (BPDUs).	switch(config)# <b>spanning-tree hello-time 3</b>
<b>spanning-tree forward-time</b> [seconds]	<b>G</b>	Use the spanning-tree forward-time global configuration command to set the forwarding-time for the specified spanning-tree instances. The forwarding time determines how long each of the listening and learning states last before the port begins forwarding.	switch(config)# <b>spanning-tree forward-time 20</b>
<b>stp-path-cost</b> [1~200000000]	<b>I</b>	Use the spanning-tree cost interface configuration command to set the path cost for Spanning Tree Protocol (STP) calculations. In the event of a loop, spanning tree considers the path cost when selecting an interface to place into the forwarding state.	switch(config)# <b>interface fastEthernet 2</b> switch(config-if)# <b>stp-path-cost 20</b>
<b>stp-path-priority</b> [Port Priority]	<b>I</b>	Use the spanning-tree port-priority interface configuration command to configure a port priority that is used when two switches tie for position as the root switch.	switch(config)# <b>interface fastEthernet 2</b> switch(config-if)# <b>stp-path-priority 128</b>
<b>stp-admin-p2p</b> [Auto True False]	<b>I</b>	Admin P2P of STP priority on this interface.	switch(config)# <b>interface fastEthernet 2</b> switch(config-if)# <b>stp-admin-p2p Auto</b>
<b>stp-admin-edge</b> [True False]	<b>I</b>	Admin Edge of STP priority on this interface.	switch(config)# <b>interface fastEthernet 2</b> switch(config-if)# <b>stp-admin-edge True</b>
<b>stp-admin-non-stp</b> [True False]	<b>I</b>	Admin NonSTP of STP priority on this interface.	switch(config)# <b>interface fastEthernet 2</b> switch(config-if)# <b>stp-admin-non-stp False</b>
<b>show spanning-tree</b>	<b>E</b>	Displays a summary of the spanning-tree states.	switch> <b>show spanning-tree</b>
<b>no spanning-tree</b>	<b>G</b>	Disable spanning-tree.	switch(config)# <b>no spanning-tree</b>

### 3.2.8 QOS Commands Set

*Table 3.8: QOS Commands Set*

Commands	Level	Description	Example
<b>qos policy</b> [weighted-fair strict]	<b>G</b>	Select QOS policy scheduling	switch(config)# <b>qos policy weighted-fair</b>
<b>qos prioritytype</b> [port-based cos-only tos-only cos-first tos-first]	<b>G</b>	Setting of QOS priority type	switch(config)# <b>qos prioritytype</b>
<b>qos priority portbased</b> [Port] [lowest low middle high]	<b>G</b>	Configure Port-based Priority	switch(config)# <b>qos priority portbased 1 low</b>
<b>qos priority cos</b> [Priority][lowest low middle high]	<b>G</b>	Configure COS Priority	switch(config)# <b>qos priority cos 0 middle</b>
<b>qos priority tos</b> [Priority][lowest low middle high]	<b>G</b>	Configure TOS Priority	switch(config)# <b>qos priority tos 3 high</b>
<b>show qos</b>	<b>P</b>	Displays the information of QoS configuration	Switch# <b>show qos</b>

<code>no qos</code>	<b>G</b>	Disable QoS function	switch(config)#no qos
---------------------	----------	----------------------	-----------------------

### 3.2.9 IGMP Commands Set

*Table 3.9: QOS Commands Set*

Commands	Level	Description	Example
<code>igmp enable</code>	<b>G</b>	Enable IGMP snooping function	switch(config)#igmp enable
<code>igmp-query auto</code>	<b>G</b>	Set IGMP query to auto mode	switch(config)#igmp-query auto
<code>igmp-query force</code>	<b>G</b>	Set IGMP query to force mode	switch(config)#igmp-query force
<code>show igmp configuration</code>	<b>P</b>	Displays the details of an IGMP configuration.	switch#show igmp configuration
<code>show igmp multi</code>	<b>P</b>	Displays the details of an IGMP snooping entries.	switch#show igmp multi
<code>no igmp</code>	<b>G</b>	Disable IGMP snooping function	switch(config)#no igmp
<code>no igmp-query</code>	<b>G</b>	Disable IGMP query	switch#no igmp-query

### 3.2.10 Mac/Filter Table Commands Set

*Table 3.10: Mac/Filter Table Commands Set*

Commands	Level	Description	Example
<code>mac-address-table static hwaddr [MAC]</code>	<b>I</b>	Configure MAC address table of interface (static).	switch(config)#interface fastEthernet 2 switch(config-if)#mac-address-table static hwaddr 000012345678
<code>mac-address-table filter hwaddr [MAC]</code>	<b>G</b>	Configure MAC address table(filter)	switch(config)#mac-address-table filter hwaddr 000012348678
<code>show mac-address-table</code>	<b>P</b>	Show all MAC address table	switch#show mac-address-table
<code>show mac-address-table static</code>	<b>P</b>	Show static MAC address table	switch#show mac-address-table static
<code>show mac-address-table filter</code>	<b>P</b>	Show filter MAC address table.	switch#show mac-address-table filter
<code>no mac-address-table static hwaddr [MAC]</code>	<b>I</b>	Remove an entry of MAC address table of interface (static)	switch(config)#interface fastEthernet 2 switch(config-if)#no mac-address-table static hwaddr 000012345678
<code>no mac-address-table filter hwaddr [MAC]</code>	<b>G</b>	Remove an entry of MAC address table (filter)	switch(config)#no mac-address-table filter hwaddr 000012348678
<code>no mac-address-table</code>	<b>G</b>	Remove dynamic entry of MAC address table	switch(config)#no mac-address-table

### 3.2.11 SNMP Commands Set

*Table 3.11: SNMP Commands Set*

Commands	Level	Description	Example
<code>snmp system-name [System Name]</code>	<b>G</b>	Set SNMP agent system name	switch(config)#snmp system-name I2switch
<code>snmp system-location [System Location]</code>	<b>G</b>	Set SNMP agent system location	switch(config)#snmp system-location lab

<b>snmp system-contact</b> [System Contact]	<b>G</b>	Set SNMP agent system contact	switch(config)#snmp system-contact where
<b>snmp agent-mode</b> [v1v2c v3 v1v2cv3]	<b>G</b>	Select the agent mode of SNMP	switch(config)#snmp agent-mode v1v2cv3
<b>snmp community-strings</b> [Community] <b>right</b> [RO/RW]	<b>G</b>	Add SNMP community string.	switch(config)#snmp community-strings public right rw
<b>snmp-server host</b> [IP address] <b>community</b> [Community-string] <b>trap-version</b> [v1 v2c]	<b>G</b>	Configure SNMP server host information and community string	switch(config)#snmp-server host 192.168.1.50 community public trap-version v1 (remove) Switch(config)# no snmp-server host 192.168.1.50
<b>snmpv3 context-name</b> [Context Name ]	<b>G</b>	Configure the context name	switch(config)#snmpv3 context-name Test
<b>snmpv3 user</b> [User Name] <b>group</b> [Group Name] <b>password</b> [Authentication Password] [Privacy Password]	<b>G</b>	Configure the userprofile for SNMPV3 agent. Privacy password could be empty.	switch(config)#snmpv3 user test01 group G1 password AuthPW PrivPW
<b>snmpv3 access context-name</b> [Context Name ] <b>group</b> [Group Name ] <b>security-level</b> [NoAuthNoPriv AuthNoPriv AuthPriv] <b>match-rule</b> [Exact Prefix] <b>views</b> [Read View Name] [Write View Name] [Notify View Name]	<b>G</b>	Configure the access table of SNMPV3 agent	switch(config)#snmpv3 access context-name Test group G1 security-level AuthPriv match-rule Exact views V1 V1 V1
<b>snmpv3 mibview view</b> [View Name] <b>type</b> [Excluded Included] <b>sub-oid</b> [OID]	<b>G</b>	Configure the mibview table of SNMPV3 agent	switch(config)#snmpv3 mibview view V1 type Excluded sub-oid 1.3.6.1
<b>show snmp</b>	<b>P</b>	Show SNMP configuration	switch#show snmp
<b>no snmp community-strings</b> [Community]	<b>G</b>	Remove the specified community.	switch(config)#no snmp community-strings public
<b>no snmp-server host</b> [Host-address]	<b>G</b>	Remove the SNMP server host.	switch(config)#no snmp-server 192.168.1.50
<b>no snmpv3 user</b> [User Name]	<b>G</b>	Remove specified user of SNMPV3 agent.	switch(config)#no snmpv3 user Test
<b>no snmpv3 access context-name</b> [Context Name ] <b>group</b> [Group Name ] <b>security-level</b> [NoAuthNoPriv AuthNoPriv AuthPriv] <b>match-rule</b> [Exact Prefix] <b>views</b> [Read View Name] [Write View Name] [Notify View Name]	<b>G</b>	Remove specified access table of SNMPV3 agent.	switch(config)#no snmpv3 access context-name Test group G1 security-level AuthPriv match-rule Exact views V1 V1 V1
<b>no snmpv3 mibview view</b> [View Name] <b>type</b> [Excluded Included] <b>sub-oid</b> [OID]	<b>G</b>	Remove specified mibview table of SNMPV3 agent.	switch(config)#no snmpv3 mibview view V1 type Excluded sub-oid 1.3.6.1

### 3.2.12 Port Mirroring Commands Set

Table 3.12: Port Mirroring Commands Set

Commands	Level	Description	Example
----------	-------	-------------	---------



<b>monitor rx</b>	<b>G</b>	Set RX destination port of monitor function	switch(config)# <b>monitor rx</b>
<b>monitor tx</b>	<b>G</b>	Set TX destination port of monitor function	switch(config)# <b>monitor tx</b>
<b>show monitor</b>	<b>P</b>	Show port monitor information	switch# <b>show monitor</b>
<b>monitor</b> [RX TX Both]	<b>I</b>	Configure source port of monitor function	switch(config)# <b>interface fastEthernet 2</b> switch(config-if)# <b>monitor RX</b>
<b>show monitor</b>	<b>I</b>	Show port monitor information	switch(config)# <b>interface fastEthernet 2</b> switch(config-if)# <b>show monitor</b>
<b>no monitor</b>	<b>I</b>	Disable source port of monitor function	switch(config)# <b>interface fastEthernet 2</b> switch(config-if)# <b>no monitor</b>

### 3.2.13 802.1x Commands Set

*Table 3.13: 802.1x Commands Set*

Commands	Level	Description	Example
<b>8021x enable</b>	<b>G</b>	Use the 802.1x global configuration command to enable 802.1x protocols.	switch(config)# <b>8021x enable</b>
<b>8021x system radiusip</b> [IP address]	<b>G</b>	Use the 802.1x system radius IP global configuration command to change the radius server IP.	switch(config)# <b>8021x system radiusip 192.168.1.1</b>
<b>8021x system serverport</b> [port ID]	<b>G</b>	Use the 802.1x system server port global configuration command to change the radius server port	switch(config)# <b>8021x system serverport 1815</b>
<b>8021x system accountport</b> [port ID]	<b>G</b>	Use the 802.1x system account port global configuration command to change the accounting port	switch(config)# <b>8021x system accountport 1816</b>
<b>8021x system sharekey</b> [ID]	<b>G</b>	Use the 802.1x system share key global configuration command to change the shared key value.	switch(config)# <b>8021x system sharekey 123456</b>
<b>8021x system nasid</b> [words]	<b>G</b>	Use the 802.1x system nasid global configuration command to change the NAS ID	switch(config)# <b>8021x system nasid test1</b>
<b>8021x misc quietperiod</b> [sec.]	<b>G</b>	Use the 802.1x misc quiet period global configuration command to specify the quiet period value of the switch.	switch(config)# <b>8021x misc quietperiod 10</b>
<b>8021x misc txperiod</b> [sec.]	<b>G</b>	Use the 802.1x misc TX period global configuration command to set the TX period.	switch(config)# <b>8021x misc txperiod 5</b>
<b>8021x misc supportimeout</b> [sec.]	<b>G</b>	Use the 802.1x misc supp timeout global configuration command to set the supplicant timeout.	switch(config)# <b>8021x misc supportimeout 20</b>
<b>8021x misc servertimeout</b> [sec.]	<b>G</b>	Use the 802.1x misc server timeout global configuration command to set the server timeout.	switch(config)# <b>8021x misc servertimeout 20</b>
<b>8021x misc maxrequest</b> [number]	<b>G</b>	Use the 802.1x misc max request global configuration command to set the MAX requests.	switch(config)# <b>8021x misc maxrequest 3</b>
<b>8021x misc reauthperiod</b> [sec.]	<b>G</b>	Use the 802.1x misc reauth period global configuration command to set the reauth period.	switch(config)# <b>8021x misc reauthperiod 3000</b>
<b>8021x portstate</b> [disable   reject   accept   authorize]	<b>I</b>	Use the 802.1x port state interface configuration command to set the state of the selected port.	switch(config)# <b>interface fastethernet 3</b> switch(config-if)# <b>8021x portstate accept</b>
<b>show 8021x</b>	<b>E</b>	Displays a summary of the 802.1x properties and also the port states.	switch> <b>show 8021x</b>
<b>no 8021x</b>	<b>G</b>	Disable 802.1x function	switch(config)# <b>no 8021x</b>

### 3.2.14 TFTP Commands Set

Table 3.14: TFTP Commands Set

Commands	Level	Description	Defaults Example
<a href="#">backup flash:backup_cfg</a>	G	Save configuration to TFTP and need to specify the IP of TFTP server and the file name of image.	switch(config)# <a href="#">backup flash:backup_cfg</a>
<a href="#">restore flash:restore_cfg</a>	G	Get configuration from TFTP server and need to specify the IP of TFTP server and the file name of image.	switch(config)# <a href="#">restore flash:restore_cfg</a>
<a href="#">upgrade flash:upgrade_fw</a>	G	Upgrade firmware by TFTP and need to specify the IP of TFTP server and the file name of image.	switch(config)# <a href="#">upgrade lash:upgrade_fw</a>

### 3.2.15 SystemLog, SMTP and Event

Table 3.15: SysLog,SMTP,Event Commands Set

Commands	Level	Description	Example
<a href="#">systemlog ip</a> [IP address]	G	Set System log server IP address.	switch(config)# <a href="#">systemlog ip 192.168.1.100</a>
<a href="#">systemlog mode</a> [client server both]	G	Specified the log mode	switch(config)# <a href="#">systemlog mode both</a>
<a href="#">show systemlog</a>	E	Displays system log.	Switch> <a href="#">show systemlog</a>
<a href="#">show systemlog</a>	P	Show system log client & server information	switch# <a href="#">show systemlog</a>
<a href="#">no systemlog</a>	G	Disable systemlog functon	switch(config)# <a href="#">no systemlog</a>
<a href="#">smtp enable</a>	G	Enable SMTP function	switch(config)# <a href="#">smtp enable</a>
<a href="#">smtp serverip</a> [IP address]	G	Configure SMTP server IP	switch(config)# <a href="#">smtp serverip 192.168.1.5</a>
<a href="#">smtp authentication</a>	G	Enable SMTP authentication	switch(config)# <a href="#">smtp authentication</a>
<a href="#">smtp account</a> [account]	G	Configure authentication account	switch(config)# <a href="#">smtp account User</a>
<a href="#">smtp password</a> [password]	G	Configure authentication password	switch(config)# <a href="#">smtp password</a>
<a href="#">smtp rcptemail</a> [Index] [Email address]	G	Configure Rcpt e-mail Address	switch(config)# <a href="#">smtp rcptemail 1 <a href="#">Alert@test.com</a></a>
<a href="#">show smtp</a>	P	Show the information of SMTP	switch# <a href="#">show smtp</a>
<a href="#">no smtp</a>	G	Disable SMTP function	switch(config)# <a href="#">no smtp</a>
<a href="#">event device-cold-start</a> [Systemlog SMTP Both]	G	Set cold start event type	switch(config)# <a href="#">event device-cold-start both</a>
<a href="#">event authentication-failure</a> [Systemlog SMTP Both]	G	Set Authentication failure event type	switch(config)# <a href="#">event authentication-failure both</a>
<a href="#">event X-ring-topology-change</a> [Systemlog SMTP Both]	G	Set X - ring topology changed event type	switch(config)# <a href="#">event X-ring-topology-change both</a>
<a href="#">event systemlog</a> [Link-UP Link-Down Both]	I	Set port event for system log	switch(config)# <a href="#">interface fastethernet 3</a> switch(config-if)# <a href="#">event systemlog both</a>
<a href="#">event smtp</a> [Link-UP Link-Down Both]	I	Set port event for SMTP	switch(config)# <a href="#">interface fastethernet 3</a> switch(config-if)# <a href="#">event smtp both</a>
<a href="#">show event</a>	P	Show event selection	switch# <a href="#">show event</a>
<a href="#">no event device-cold-start</a>	G	Disable cold start event type	switch(config)# <a href="#">no event device-cold-start</a>
<a href="#">no event authentication-failure</a>	G	Disable Authentication failure event type	switch(config)# <a href="#">no event authentication-failure</a>
<a href="#">no event X-ring-topology-change</a>	G	Disable X - ring topology changed event type	switch(config)# <a href="#">no event X-ring-topology-change</a>
<a href="#">no event systemlog</a>	I	Disable port event for system log	switch(config)# <a href="#">interface fastethernet 3</a> switch(config-if)# <a href="#">no event systemlog</a>
<a href="#">no event smtp</a>	I	Disable port event for SMTP	switch(config)# <a href="#">interface fastethernet 3</a> switch(config-if)# <a href="#">no event smtp</a>

<a href="#">show systemlog</a>	<b>P</b>	Show system log client & server information	switch# <b>show systemlog</b>
--------------------------------	----------	---	-------------------------------

### 3.2.16 SNTP Commands Set

*Table 3.16: SNTP Commands Set*

Commands	Level	Description	Example
<a href="#">sntp enable</a>	<b>G</b>	Enable SNTP function	switch(config)# <b>sntp enable</b>
<a href="#">sntp daylight</a>	<b>G</b>	Enable daylight saving time, if SNTP function is inactive, this command can't be applied.	switch(config)# <b>sntp daylight</b>
<a href="#">sntp daylight-period</a> [Start time] [End time]	<b>G</b>	Set period of daylight saving time, if SNTP function is inactive, this command can't be applied. Parameter format: [yyyymmdd-hh:mm]	switch(config)# <b>sntp daylight-period 20060101-01:01 20060202-01-01</b>
<a href="#">sntp daylight-offset</a> [Minute]	<b>G</b>	Set offset of daylight saving time, if SNTP function is inactive, this command can't be applied.	switch(config)# <b>sntp daylight-offset 3</b>
<a href="#">sntp ip</a> [IP]	<b>G</b>	Set SNTP server IP, if SNTP function is inactive, this command can't be applied.	switch(config)# <b>sntp ip 192.169.1.1</b>
<a href="#">sntp timezone</a> [Timezone]	<b>G</b>	Set timezone index, use "show sntp timzezone" command to get more information of index number	switch(config)# <b>sntp timezone 22</b>
<a href="#">show sntp</a>	<b>P</b>	Show SNTP information	switch# <b>show sntp</b>
<a href="#">show sntp timezone</a>	<b>P</b>	Show index number of time zone list	switch# <b>show sntp timezone</b>
<a href="#">no sntp</a>	<b>G</b>	Disable SNTP function	switch(config)# <b>no sntp</b>
<a href="#">no sntp daylight</a>	<b>G</b>	Disable daylight saving time	switch(config)# <b>no sntp daylight</b>

### 3.2.17 X-ring Commands Set

*Table 3.17: X-ring Commands Set*

Commands	Level	Description	Example
<a href="#">ring enable</a>	<b>G</b>	Enable X-ring	switch(config)# <b>ring enable</b>
<a href="#">ring master</a>	<b>G</b>	Enable ring master	switch(config)# <b>ring master</b>
<a href="#">ring couplering</a>	<b>G</b>	Enable couple ring	switch(config)# <b>ring couplering</b>
<a href="#">ring dualhoming</a>	<b>G</b>	Enable dual homing	switch(config)# <b>ring dualhoming</b>
<a href="#">ring ringport</a> [1st Ring Port] [2nd Ring Port]	<b>G</b>	Configure 1st/2nd Ring Port	switch(config)# <b>ring ringport 7 8</b>
<a href="#">ring couplingport</a> [Coupling Port]	<b>G</b>	Configure Coupling Port	switch(config)# <b>ring couplingport 1</b>
<a href="#">ring controlport</a> [Control Port]	<b>G</b>	Configure Control Port	switch(config)# <b>ring controlport 2</b>
<a href="#">ring homingport</a> [Dual Homing Port]	<b>G</b>	Configure Dual Homing Port	switch(config)# <b>ring homingport 3</b>
<a href="#">show ring</a>	<b>P</b>	Show the information of X - Ring	switch# <b>show ring</b>
<a href="#">no ring</a>	<b>G</b>	Disable X-ring	switch(config)# <b>no ring</b>
<a href="#">no ring master</a>	<b>G</b>	Disable ring master	switch(config)# <b>no ring master</b>
<a href="#">no ring couplering</a>	<b>G</b>	Disable couple ring	switch(config)# <b>no ring couplering</b>
<a href="#">no ring dualhoming</a>	<b>G</b>	Disable dual homing	switch(config)# <b>no ring dualhoming</b>

### 3.3 Web Browser

EKI-7758F provides a convenient configuring way via web browser. You can follow the steps below to access EKI-7758F.

EKI-7758F's default IP is 192.168.1.1. Make sure your host PC and EKI-7758F are on the same logical sub-network.

*Warning*            *Your host PC should be in the same VLAN setting with EKI-7758F, or the management will not be configured.*

Connect EKI-7758F to the Ethernet then your host PC could be configured via Ethernet. Or you can directly connect EKI-7758F to your host PC with a straight-through or cross over Ethernet cable.

Before to use web management, install the industrial switch on the network and make sure that any one of PCs on the network can connect with the industrial switch through the web browser. The industrial switch default value of IP, subnet mask, username and password are as below:

- IP Address: 192.168.1.1
- Subnet Mask: 255.255.255.0
- Default Gateway: 192.168.1.254
- User Name: admin
- Password: admin

Open Internet Explorer and type EKI-7657C's IP in the Address field then press Enter to open the web login page.



Figure 3.3-1    Type the address in the URL



Figure 3.3-2    Web Login Window

The default user name and password are both **admin**. Fill in the user name and password and then press **OK** to enter the configuration. You can change the password in the User Authentication section.

In the main page, you can find the tree menu structure of the Ethernet switch in the left side. Click the “+” symbol to unroll the hiding hyperlink, and click any one of the hyperlinks to open its function page.

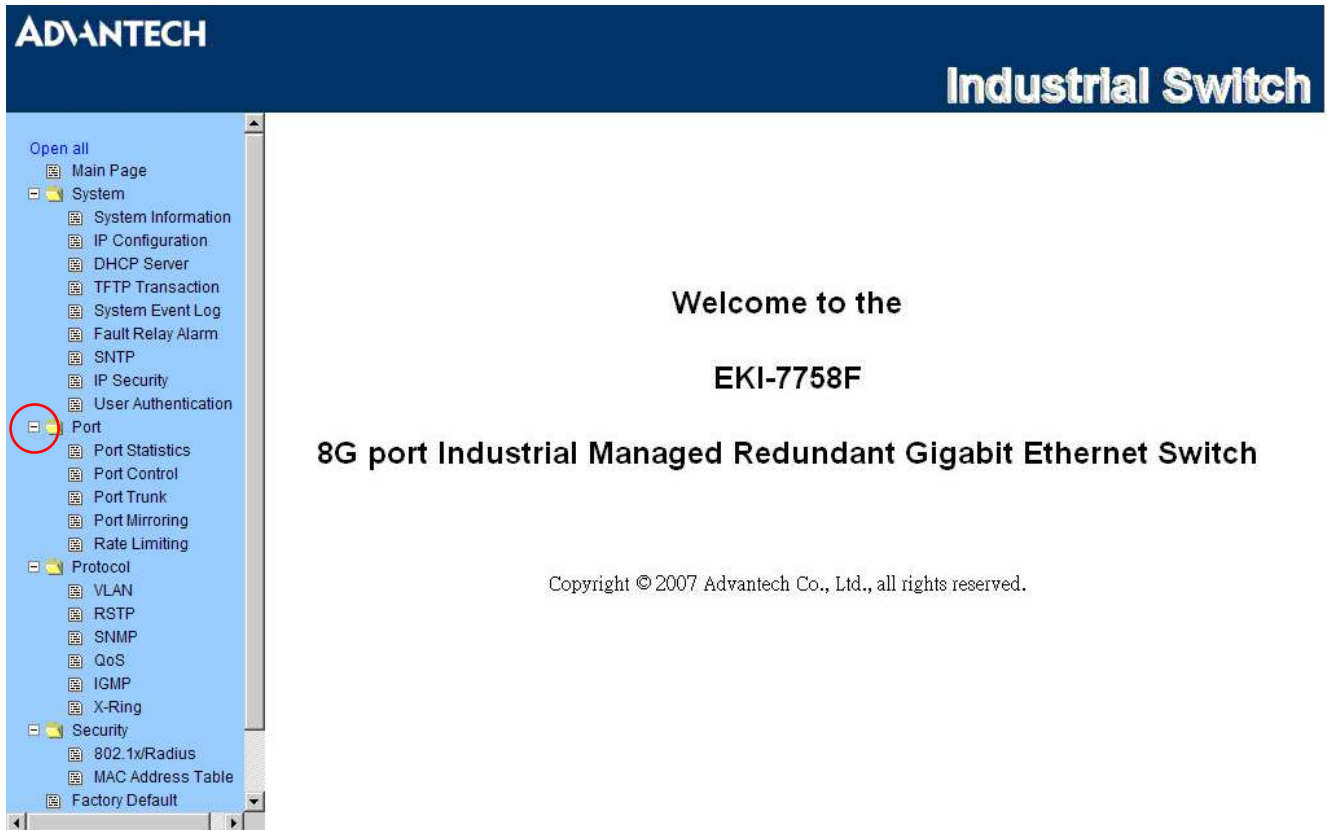

Figure 3.3-3 Main Page

### 3.3.1 System

#### System Information

Assign the system name, location and view the system information

- **System Name:** Assign the name of the switch. The maximum length is 64 bytes.
- **System Description:** Displays the description of switch. Read only cannot be modified.
- **System Location:** Assign the switch physical location. The maximum length is 64 bytes.
- **System Contact:** Enter the name of contact person or organization.
- **Firmware Version:** Displays the switch's firmware version.
- **Kernel Version:** Displays the kernel software version.
- **MAC Address:** Displays the unique hardware address assigned by manufacturer (default).

*Warning*

*Don't set "0" for the first segment of the subnet mask and default gateway (000.xxx.xxx.xxx).*

*Refresh the web screen if the web could not be displayed while you change the setting.*

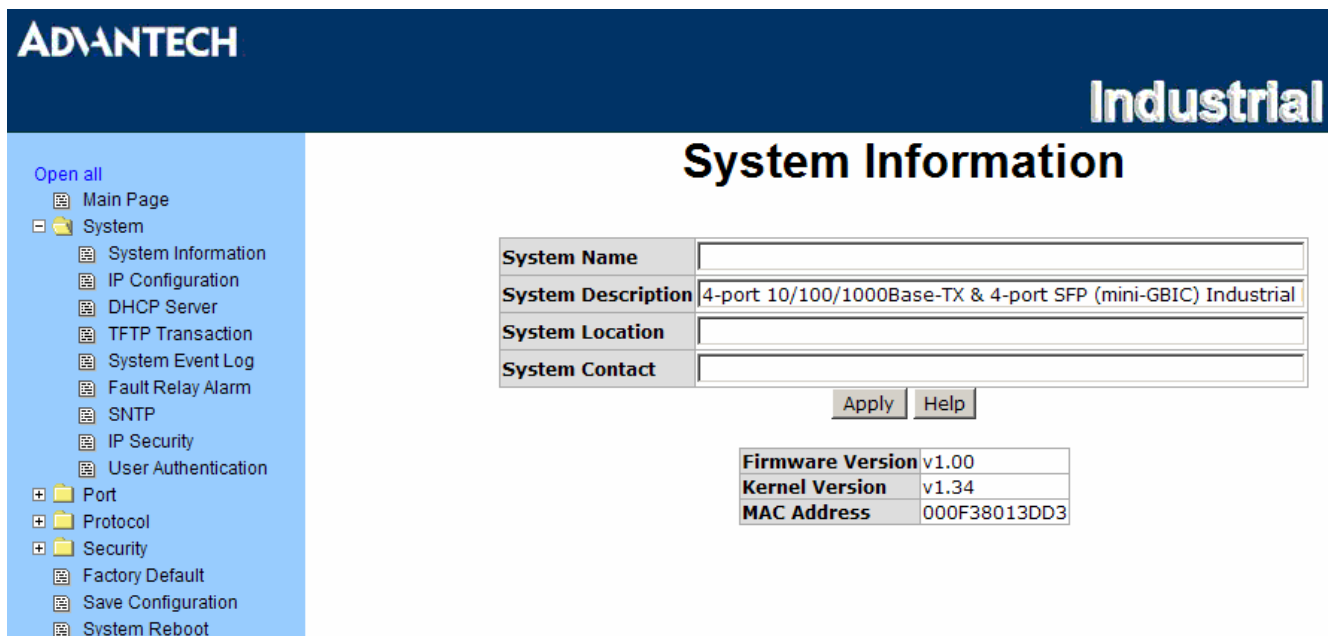

The screenshot displays the 'System Information' page of the ADVANTECH Industrial web interface. On the left is a navigation menu with 'System Information' selected. The main area contains a form with the following fields:

System Name	<input type="text"/>
System Description	4-port 10/100/1000Base-TX & 4-port SFP (mini-GBIC) Industrial
System Location	<input type="text"/>
System Contact	<input type="text"/>

Below the form are 'Apply' and 'Help' buttons. A table at the bottom right shows the following information:

Firmware Version	v1.00
Kernel Version	v1.34
MAC Address	000F38013DD3

Figure 3.3-4 System Information

## IP Configuration

The interface allows users to configure the switch to receive an IP address from DHCP server or manually fill in **IP Address**, **Subnet Mask**, **Gateway**, IP addresses of the primary and the secondary DNS servers.

- **DHCP Client:** Enable or disable the DHCP client function. When DHCP client function is enabled, the industrial switch will be assigned an IP address from the network DHCP server. The default IP address will be replaced by the assigned IP address on DHCP server. After users click **Apply**, a popup dialog shows up. It is to inform the user that when the DHCP client is enabled, the current IP will lose and user should find the new IP on the DHCP server.
- **IP Address:** Assign the IP address that the network is using. If DHCP client function is enabled, and then the user doesn't need to assign the IP address. And, the network DHCP server will assign the IP address displaying in this column for the industrial switch. The default IP is 192.168.1.1.
- **Subnet Mask:** Assign the subnet mask to the IP address. If DHCP client function is enabled, and then the user does not need to assign the subnet mask.
- **Gateway:** Assign the network gateway for the industrial switch. The default gateway is 192.168.1.254.
- **DNS1:** The abbreviation of Domain Name Server—an Internet service that translate domain name into IP addresses. Domain name are alphabetic which are easy to be remembered. Because the Internet is based on IP address; every time you use a domain name, therefore, a DNS service must translate the name into the corresponding IP address. For example, the domain name **www.net.com** might translate to 192.168.1.1
- **DNS2:** The backup for DNS1. When DNS1 cannot function, DNS2 will then replace DNS1 immediately.
- And then, click  .

The screenshot shows the ADANTECH Industrial Switch web interface. The title bar reads 'ADANTECH Industrial Switch'. The main heading is 'IP Configuration'. On the left is a navigation menu with 'IP Configuration' highlighted. The configuration area includes a 'DHCP Client' dropdown set to 'Disable', and a table of fields:

IP Address	192.168.1.1
Subnet Mask	255.255.255.0
Gateway	192.168.1.254
DNS1	0.0.0.0
DNS2	0.0.0.0

At the bottom of the configuration area are 'Apply' and 'Help' buttons.

Figure 3.3-5 IP Configuration

## DHCP Server – System configuration

DHCP is the abbreviation of Dynamic Host Configuration Protocol that is a protocol for assigning dynamic IP addresses to devices on a network. With dynamic addressing, a device can have a different IP address every time it connects to the network. In some systems, the device's IP address can even change while it is still connected. DHCP also supports a mix of static and dynamic IP addresses. Dynamic addressing simplifies network administration because the software keeps track of IP addresses rather than requiring an administrator to manage the task. This means that a new computer can be added to a network without the hassle of manually assigning it a unique IP address.

The system provides the DHCP server function. The system provides the DHCP server function. Having enabled the DHCP server function, the switch system can be a DHCP server.

- **DHCP Server:** Enable or Disable the DHCP Server function. Enable—the switch will be the DHCP server on your local network.
- **Low IP Address:** Type in an IP address. Low IP address is the beginning of the dynamic IP range. For example, dynamic IP is in the range between 192.168.1.100 ~ 192.168.1.200. In contrast, 192.168.1.100 is the Low IP address.
- **High IP Address:** Type in an IP address. High IP address is the end of the dynamic IP range. For example, dynamic IP is in the range between 192.168.1.100 ~ 192.168.1.200. In contrast, 192.168.1.200 is the High IP address.
- **Subnet Mask:** Type in the subnet mask of the IP configuration.
- **Gateway:** Type in the IP address of the gateway in your network.
- **DNS:** Type in the Domain Name Server IP Address in your network.
- **Lease Time (sec):** It is the time period that system will reset the dynamic IP assignment to ensure the dynamic IP will not be occupied for a long time or the server doesn't know that the dynamic IP is idle.
- And then, click .

The screenshot displays the 'DHCP Server - System Configuration' interface. On the left is a navigation tree with categories like System, Port, Protocol, and Security. The 'DHCP Server' option is selected. The main area shows three tabs: 'System Configuration', 'Client Entries', and 'Port and IP Binding'. The 'System Configuration' tab is active, showing a 'DHCP Server' dropdown menu set to 'Disable'. Below this is a table of configuration parameters:

Low IP Address	192.168.1.100
High IP Address	192.168.1.200
Subnet Mask	255.255.255.0
Gateway	192.168.1.254
DNS	0.0.0.0
Lease Time (sec)	86400

At the bottom of the configuration area are 'Apply' and 'Help' buttons.

Figure 3.3-6 DHCP Server - System Configuration



## DHCP Server – Client Entries

When the DHCP server function is active, the system will collect the DHCP client information and displays it here.

The screenshot shows the ADVANTECH Industrial S web interface. The top navigation bar includes the ADVANTECH logo and the text 'Industrial S'. The main title is 'DHCP Server - Client Entries'. Below the title are three tabs: 'System Configuration', 'Client Entries' (which is selected), and 'Port and IP Binding'. A table header is visible with columns: 'IP addr', 'Client ID', 'Type', 'Status', and 'Lease'. On the left side, there is a navigation menu with the following items: 'Open all', 'Main Page', 'System' (expanded), 'System Information', 'IP Configuration', 'DHCP Server', 'TFTP Transaction', 'System Event Log', 'Fault Relay Alarm', 'SNTP', 'IP Security', 'User Authentication', 'Port', 'Protocol', 'Security', 'Factory Default', 'Save Configuration', and 'System Reboot'.

Figure 3.3-7 DHCP Server – Client Entries

## DHCP Server - Port and IP Bindings

Assign the dynamic IP address to the particular port. When the device is connecting to the port and asks for IP assigning, the system will assign the pre-configured IP address to the connected device.

The screenshot displays the configuration interface for the DHCP Server's Port and IP Bindings. The interface includes a navigation menu on the left and a main configuration area with three tabs: System Configuration, Client Entries, and Port and IP Binding. The Port and IP Binding tab is active, showing a table with 8 rows, each representing a port (Port.01 to Port.08) and its corresponding IP address (0.0.0.0). Below the table are 'Apply' and 'Help' buttons.

Port	IP
Port.01	0.0.0.0
Port.02	0.0.0.0
Port.03	0.0.0.0
Port.04	0.0.0.0
Port.05	0.0.0.0
Port.06	0.0.0.0
Port.07	0.0.0.0
Port.08	0.0.0.0

Figure 3.3-8 DHCP Server – Port and IP Binding

## TFTP - Update Firmware

Trivial File Transfer Protocol (TFTP) is a very simple file transfer protocol, with the functionality of a very basic form of FTP. It provides the functions to allow the user to update the switch firmware. Before updating, make sure you have your TFTP server ready and the firmware image is on the TFTP server.

- **TFTP Server IP Address:** Fill in your TFTP server IP.
- **Firmware File Name:** Type in the name of firmware image.
- And then, click

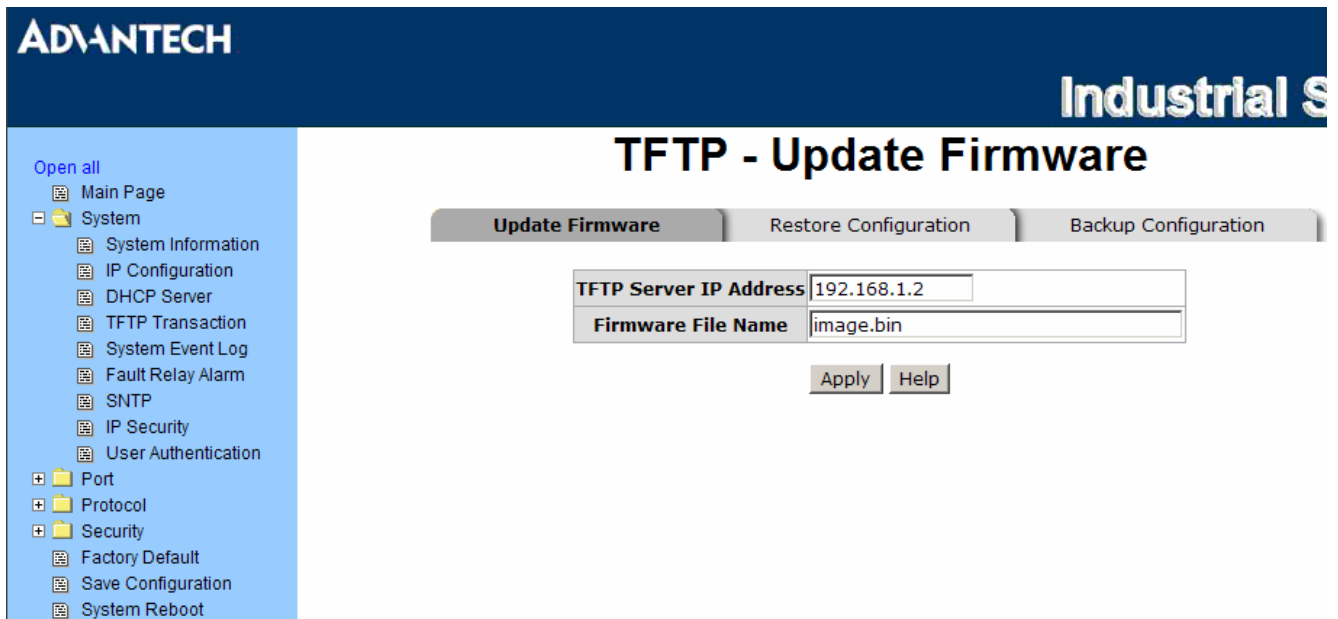

Figure 3.3-9 TFTP – Update Firmware

## TFTP – Restore Configuration

You can restore the configuration from TFTP server. Before doing that, you must put the image file on the TFTP server first for the switch to download back the flash image.

- **TFTP Server IP Address:** Fill in the TFTP server IP.
- **Restore File Name:** Fill in the correct file name for restoration.
- Click

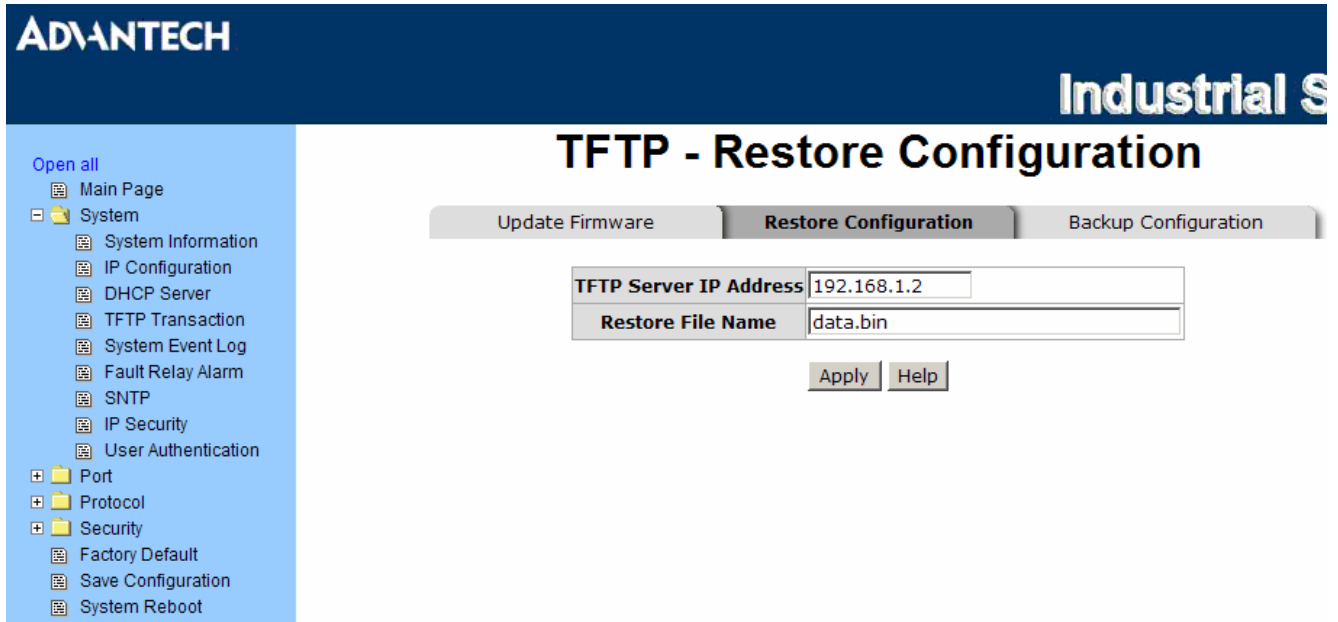

Figure 3.3-10 TFTP – Restore Configuration

## TFTP - Backup Configuration

You can save the current Flash ROM value from the switch to the TFTP server for later restoration.

- **TFTP Server IP Address:** Fill in the TFTP server IP
- **Backup File Name:** Fill in the file name
- Click .

The screenshot shows the 'TFTP - Backup Configuration' page in a web browser. The page has a dark blue header with the 'ADVANTECH' logo on the left and 'Industrial S' on the right. Below the header is a navigation menu on the left with a blue background, listing various system settings. The main content area has a title 'TFTP - Backup Configuration' and three tabs: 'Update Firmware', 'Restore Configuration', and 'Backup Configuration'. The 'Backup Configuration' tab is active. Below the tabs are two input fields: 'TFTP Server IP Address' with the value '192.168.1.2' and 'Backup File Name' with the value 'data.bin'. At the bottom of the form are two buttons: 'Apply' and 'Help'.

Update Firmware	Restore Configuration	Backup Configuration
<b>TFTP Server IP Address</b> <input type="text" value="192.168.1.2"/>		
<b>Backup File Name</b> <input type="text" value="data.bin"/>		
<input type="button" value="Apply"/> <input type="button" value="Help"/>		

Figure 3.3-11 TFTP – Backup Configuration

## System Event Log – Syslog Configuration

Configure the system event mode to collect system log.

- **Syslog Client Mode:** Select the system log mode—**Client Only**, **Server Only**, or **Both**.
- **System Log Server IP Address:** Assign the system log server IP.
- When Syslog Client Mode is set as **Client Only**, the system event log will only be reserved in the switch's RAM until next reboot. When Syslog Client Mode is set as **Server Only**, the system log will only be sent to the syslog server and you have to type the IP address in the Syslog Server IP Address column. If the Syslog Client Mode is set as **Both**, the system log will be reserved in the switch's RAM and sent to server.
- Click **Reload** to refresh the events log.
- Click **Clear** to clear all current events log.
- After configuring, click **Apply**.

The screenshot displays the Advantech Industrial Switch web interface for Syslog Configuration. The left sidebar contains a navigation menu with categories like System, Port, Protocol, and Security. The main content area is titled 'System Event Log - Syslog Configuration' and features three tabs: 'Syslog Configuration', 'SMTP Configuration', and 'Event Configuration'. The 'Syslog Configuration' tab is active, showing a form with 'Syslog Client Mode' set to 'Both' and 'Syslog Server IP Address' set to '192.168.1.180'. Below the form is a log display area with two entries: '2: Jan 1 06:39:55 : System Log Server IP: 192.168.1.180' and '1: Jan 1 06:39:55 : System Log Enable!'. A page selector dropdown is open, showing 'Page.1' through 'Page.10'. At the bottom of the configuration area are three buttons: 'Reload', 'Clear', and 'Help'.

Figure 3.3-12 Syslog Configuration

## System Event Log - SMTP Configuration

You can set up the mail server IP, mail account, password, and forwarded email account for receiving the event alert.

- **Email Alert:** Enable or disable the email alert function.
- **SMTP Server IP:** Set up the mail server IP address (when **Email Alert** enabled, this function will then be available).
- **Sender:** Type in an alias of the switch in complete email address format, e.g. [switch01@123.com](mailto:switch01@123.com), to identify where the event log comes from.
- **Authentication:** Tick the checkbox to enable this function, configuring the email account and password for authentication (when **Email Alert** enabled, this function will then be available).
- **Mail Account:** Set up the email account, e.g. [Tomadmin](mailto:Tomadmin), to receive the alert. It must be an existing email account on the mail server, which you had set up in **SMTP Server IP Address** column.
- **Password:** Type in the password to the email account.
- **Confirm Password:** Reconfirm the password.
- **Rcpt e-mail Address 1 ~ 6:** You can also assign up to 6 e-mail accounts to receive the alert.
- Click  .

The screenshot displays the 'System Event Log - SMTP Configuration' page. On the left is a navigation menu with categories like System, Port, Protocol, and Security. The main content area has three tabs: 'Syslog Configuration', 'SMTP Configuration' (selected), and 'Event Configuration'. At the top of the form, there is a dropdown for 'E-mail Alert' set to 'Enable'. The configuration fields are as follows:

SMTP Server IP Address :	<input type="text" value="192.168.1.5"/>
Sender :	<input type="text" value="switch01@123.com"/>
<input checked="" type="checkbox"/> Authentication	
Mail Account :	<input type="text" value="Tomadmin"/>
Password :	<input type="password" value="....."/>
Confirm Password :	<input type="password" value="....."/>
Rcpt e-mail Address 1 :	<input type="text" value="supervisor@123.com"/>
Rcpt e-mail Address 2 :	<input type="text"/>
Rcpt e-mail Address 3 :	<input type="text"/>
Rcpt e-mail Address 4 :	<input type="text"/>
Rcpt e-mail Address 5 :	<input type="text"/>
Rcpt e-mail Address 6 :	<input type="text"/>

At the bottom of the form are two buttons:  and .

Figure 3.3-13 SMTP Configuration

## System Event Log - Event Configuration

When the **Syslog/SMTP** checkbox is ticked, the event log will be sent to the system log server/SMTP server. Also, per port log (link up, link down, and both) events can be sent to the system log server/SMTP server with the respective checkbox ticked. After configuring, click 'Apply' to have the setting taken effect.

- **System event selection:** There are 4 event types—Device cold start, Device warm start, Authentication Failure, and X-ring topology change. Before you can tick the checkbox of each event type, the Syslog Client Mode column on the Syslog Configuration tab/E-mail Alert column on the SMTP Configuration tab must be enabled first.
  - **Device cold start:** When the device executes cold start action, the system will issue a log event.
  - **Device warm start:** When the device executes warm start, the system will issue a log event.
  - **Authentication Failure:** When the SNMP authentication fails, the system will issue a log event.
  - **X-ring topology change:** When the X-ring topology has changed, the system will issue a log event.
- **Port event selection:** Also, before the drop-down menu items are available, the Syslog Client Mode column on the Syslog Configuration tab/E-mail Alert column on the SMTP Configuration tab must be enabled first. Those drop-down menu items have 3 selections—Link UP, Link Down, and Link UP & Link Down. Disable means no event will be sent to the system log server/SMTP server.
  - **Link UP:** The system will issue a log message when port connection links up only.
  - **Link Down:** The system will issue a log message when port connection links down only.
  - **Link UP & Link Down:** The system will issue a log message when port connection is up and down.

**ADVANTECH** Industrial S

### System Event Log - Event Configuration

Syslog Configuration | SMTP Configuration | **Event Configuration**

**System event selection**

Event Type	Syslog	SMTP
Device cold start	<input type="checkbox"/>	<input checked="" type="checkbox"/>
Device warm start	<input type="checkbox"/>	<input checked="" type="checkbox"/>
Authentication Failure	<input type="checkbox"/>	<input checked="" type="checkbox"/>
X-Ring topology change	<input type="checkbox"/>	<input checked="" type="checkbox"/>

**Port event selection**

Port	Syslog	SMTP
Port.01	Disable	Disable
Port.02	Disable	Disable
Port.03	Disable	Disable
Port.04	Disable	Disable
Port.05	Disable	Disable
Port.06	Disable	Disable
Port.07	Disable	Disable
Port.08	Disable	Disable

Apply Help

Figure 3.3-14 Event Configuration



## Fault Relay Alarm

- **Power Failure:** Tick the checkbox to enable the function of lighting up the **FAULT** LED on the panel when power fails.
- **Port Link Down/Broken:** Tick the checkbox to enable the function of lighting up the **FAULT** LED on the panel when ports' states are link-down or broken.

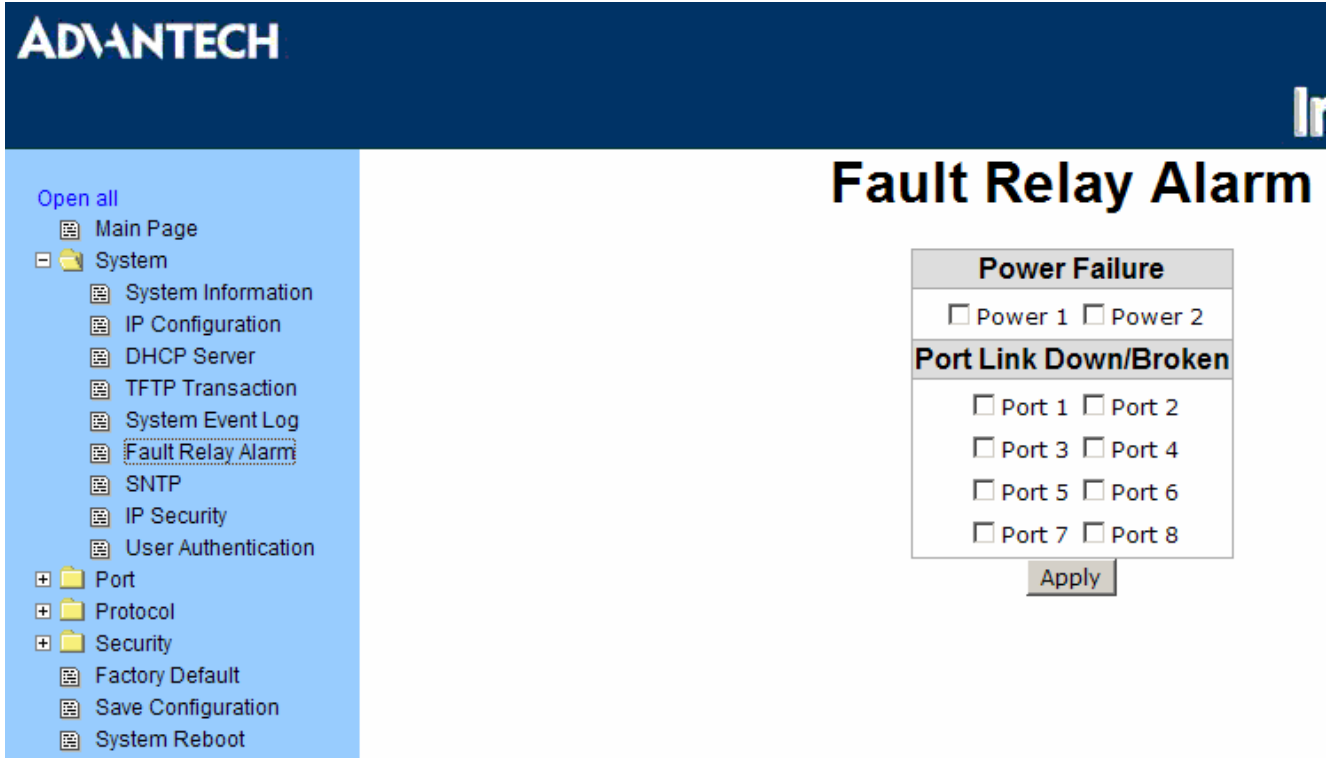

Figure 3.3-15 Fault Relay Alarm

## SNTP Configuration

You can configure the SNTP (Simple Network Time Protocol) settings which allow you to synchronize switch clocks on the Internet.

- **SNTP Client:** Enable/disable SNTP function to get the time from the SNTP server.
- **Daylight Saving Time:** Enable/disable daylight saving time function. When daylight saving time is enabled, you need to configure the daylight saving time period.
- **UTC Timezone:** Set the switch location time zone. The following table lists the different location time zone for your reference.

<i>Table 3.18: UTC Timezone</i>		
Local Time Zone	Conversion from UTC	Time at 12:00 UTC
November Time Zone	- 1 hour	11am
Oscar Time Zone	-2 hours	10 am
ADT - Atlantic Daylight	-3 hours	9 am
AST - Atlantic Standard EDT - Eastern Daylight	-4 hours	8 am
EST - Eastern Standard CDT - Central Daylight	-5 hours	7 am
CST - Central Standard MDT - Mountain Daylight	-6 hours	6 am
MST - Mountain Standard PDT - Pacific Daylight	-7 hours	5 am
PST - Pacific Standard ADT - Alaskan Daylight	-8 hours	4 am
ALA - Alaskan Standard	-9 hours	3 am
HAW - Hawaiian Standard	-10 hours	2 am
Nome, Alaska	-11 hours	1 am
CET - Central European FWT - French Winter MET - Middle European MEWT - Middle European Winter SWT - Swedish Winter	+1 hour	1 pm
EET - Eastern European, USSR Zone 1	+2 hours	2 pm
BT - Baghdad, USSR Zone 2	+3 hours	3 pm
ZP4 - USSR Zone 3	+4 hours	4 pm

ZP5 - USSR Zone 4	+5 hours	5 pm
ZP6 - USSR Zone 5	+6 hours	6 pm
WAST - West Australian Standard	+7 hours	7 pm
CCT - China Coast, USSR Zone 7	+8 hours	8 pm
JST - Japan Standard, USSR Zone 8	+9 hours	9 pm
EAST - East Australian Standard GST Guam Standard, USSR Zone 9	+10 hours	10 pm
IDLE - International Date Line NZST - New Zealand Standard NZT - New Zealand	+12 hours	Midnight

- **SNTP Sever URL:** Set the SNTP server IP address.
- **Switch Timer:** Displays the current time of the switch.
- **Daylight Saving Period:** Set up the Daylight Saving beginning time and Daylight Saving ending time. Both will be different in every year.
- **Daylight Saving Offset (mins):** For non-US and European countries, specify the amount of time for day light savings.
- **Synchronization Interval (secs):** The Synchronization Interval is used for sending synchronizing packets periodically. Users can assign the time ranging from 64 to 1024 seconds. The “0” value displaying by default means that you disable the auto-synchronized feature in the SNTP client mode. You can enable the feature by filling the interval range from 64 ~ 1024 seconds.
- Click  .

ADVANTECH
Industrial Switch

Open all

- [-] Main Page
- [-] System
  - [-] System Information
  - [-] IP Configuration
  - [-] DHCP Server
  - [-] TFTP Transaction
  - [-] System Event Log
  - [-] Fault Relay Alarm
  - [-] SNTP
  - [-] IP Security
  - [-] User Authentication
- [+] Port
- [+] Protocol
- [+] Security
  - [-] Factory Default
  - [-] Save Configuration
  - [-] System Reboot

## SNTP Configuration

SNTP Client :

Daylight Saving Time :

<b>UTC Timezone</b>	(GMT)Greenwich Mean Time: Dublin, Edinburgh, Lisbon, London
<b>SNTP Server URL</b>	<input type="text" value="0.0.0.0"/>
<b>Switch Timer</b>	<input type="text"/>
<b>Daylight Saving Period</b>	<input type="text" value="20040101 00:0"/> <input type="text" value="20040101 00:0"/>
<b>Daylight Saving Offset(mins)</b>	<input type="text" value="0"/>
<b>Synchronization Interval(secs)</b>	<input type="text" value="0"/>

Figure 3.3-16 SNTP Configuration

## IP Security

IP security function allows the user to assign 10 specific IP addresses that have permission to access the switch through the web browser for the securing switch management.

- **IP Security Mode:** When this option is in **Enable** mode, the **Enable HTTP Server** and **Enable Telnet Server** checkboxes will then be available.
- **Enable HTTP Server:** When this checkbox is ticked, the IP addresses among Security IP1 ~ IP10 will be allowed to access this switch via HTTP service.
- **Enable Telnet Server:** When this checkbox is ticked, the IP addresses among Security IP1 ~ IP10 will be allowed to access this switch via telnet service.
- **Security IP 1 ~ 10:** The system allows the user to assign up to 10 specific IP addresses for access security. Only these 10 IP addresses can access and manage the switch through the HTTP/Telnet service.
- And then, click  to have the configuration take effect.

*Note* Remember to execute the "Save Configuration" action, otherwise the new configuration will lose when the switch powers off.

**ADVANTECH**

Open all

- System Information
- IP Configuration
- DHCP Server
- TFTP Transaction
- System Event Log
- Fault Relay Alarm
- SNTP
- IP Security
- User Authentication

Port

Protocol

Security

- Factory Default
- Save Configuration
- System Reboot

## IP Security

IP Security Mode:

Enable HTTP Server

Enable Telnet Server

Security IP1	<input type="text" value="192.168.1.77"/>
Security IP2	<input type="text" value="192.168.1.89"/>
Security IP3	<input type="text" value="192.168.1.120"/>
Security IP4	<input type="text" value="0.0.0.0"/>
Security IP5	<input type="text" value="0.0.0.0"/>
Security IP6	<input type="text" value="0.0.0.0"/>
Security IP7	<input type="text" value="0.0.0.0"/>
Security IP8	<input type="text" value="0.0.0.0"/>
Security IP9	<input type="text" value="0.0.0.0"/>
Security IP10	<input type="text" value="0.0.0.0"/>

Figure 3.3-17 IP Security

## User Authentication

Change the web management login user name and password for the management security issue.

- **User name:** Key in the new user name (The default is “admin”).
- **Password:** Key in the new password (The default is “admin”).
- **Confirm password:** Re-type the new password.
- And then, click **Apply** to have the configuration take effect.

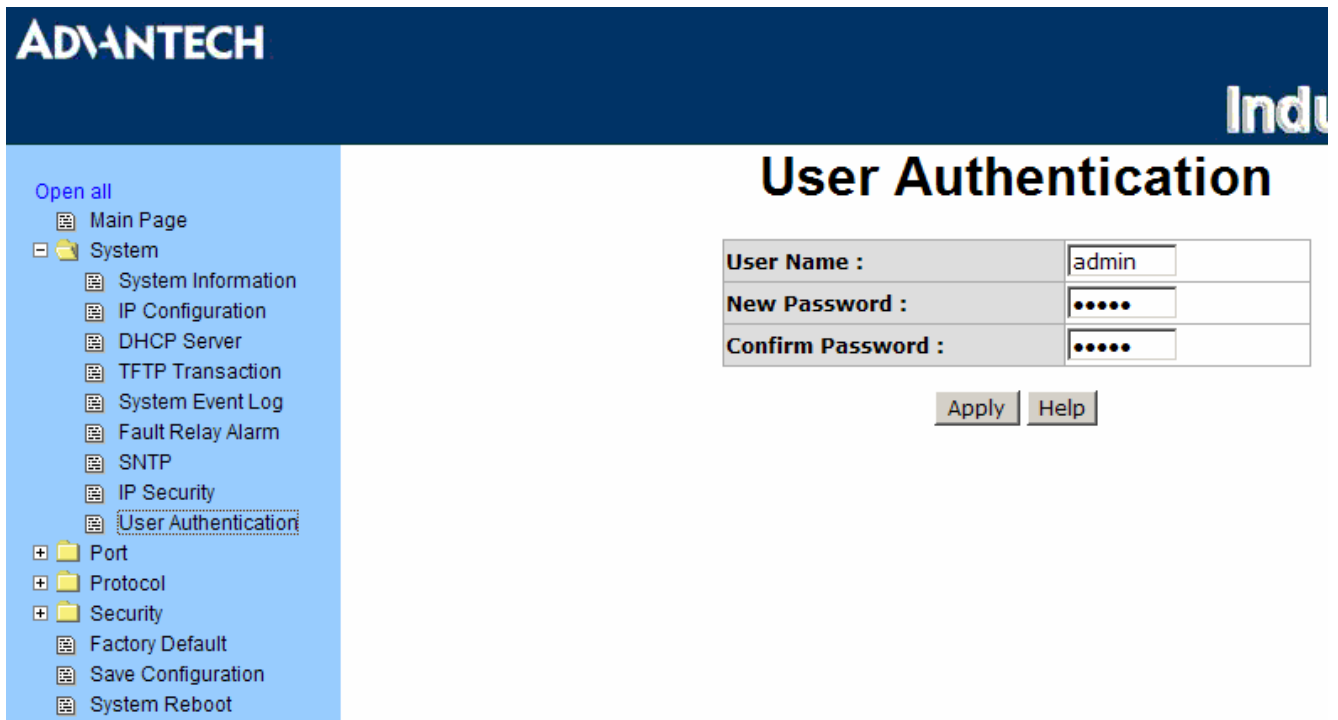

Figure 3.3-18 User Authentication

### 3.3.2 Port

Port setting includes Port Statistics, Port Control, Port Trunk, Port Mirroring, and Rate Limiting. The user can use this interface to set the parameters and control the packet flow among the ports.

#### Port Statistics

The following information provides the current port statistic information.

- **Port:** Displays the port number.
- **Type:** Displays the media type of the port.
- **Link:** The status of linking—'Up' or 'Down'.
- **State:** The user can set the state of the port as 'Enable' or 'Disable' via Port Control. When the state is disabled, the port will not transmit or receive any packet.
- **Tx Good Packet:** The counts of transmitting good packets via this port.
- **Tx Bad Packet:** The counts of transmitting bad packets (including undersize [less than 64 bytes], oversize, CRC Align errors, fragments and jabbers packets) via this port.
- **Rx Good Packet:** The counts of receiving good packets via this port.
- **Rx Bad Packet:** The counts of receiving bad packets (including undersize [less than 64 bytes], oversize, CRC error, fragments and jabbers) via this port.
- **Tx Abort Packet:** The aborted packet while transmitting.
- **Packet Collision:** The counts of collision packet.
- **Packet Dropped:** The counts of dropped packet.
- **Rx Bcast Packet:** The counts of broadcast packet.
- **Rx Mcast Packet:** The counts of multicast packet.
- Click  to clean all counts.

**ADVANTECH** Industrial Switch

### Port Statistics

Port	Type	Link	State	Tx Good Packet	Tx Bad Packet	Rx Good Packet	Rx Bad Packet	Tx Abort Packet	Packet Collision	Packet Dropped	RX Bcast Packet	RX Mcast Packet
Port.01	1000TX	Down	Enable	0	0	0	0	0	0	0	0	0
Port.02	1000TX	Down	Enable	0	0	0	0	0	0	0	0	0
Port.03	1000TX	Up	Enable	673	0	1645	0	0	0	0	230	7
Port.04	1000TX	Down	Enable	0	0	0	0	0	0	0	0	0
Port.05	mGBIC	Down	Enable	0	0	0	0	0	0	0	0	0
Port.06	mGBIC	Down	Enable	0	0	0	0	0	0	0	0	0
Port.07	mGBIC	Down	Enable	0	0	0	0	0	0	0	0	0
Port.08	mGBIC	Down	Enable	0	0	0	0	0	0	0	0	0

Figure 3.3-19 Port Statistics

## Port Control

In Port Control, you can pull down the selection items to set the parameters of each port to control the transmitting/receiving packets.

- **Port:** Select the port that you want to configure.
- **State:** Current port status. The port can be set to disable or enable mode. If the port state is set as 'Disable', it will not receive or transmit any packet.
- **Negotiation:** Auto and Force. Being set as Auto, the speed and duplex mode are negotiated automatically. When you set it as Force, you have to assign the speed and duplex mode manually.
- **Speed:** It is available for selecting when the Negotiation column is set as Force. When the Negotiation column is set as Auto, this column is read only.
- **Duplex:** It is available for selecting when the Negotiation column is set as Force. When the Negotiation column is set as Auto, this column is read only.
- **Flow Control:** Set flow control function as Enable or Disable. When enabled, once the device exceed the input data rate of another device as a result the receiving device will send a PAUSE frame which halts the transmission of the sender for a specified period of time. When disabled, the receiving device will drop the packet if too much to process.
- **Security:** Once the Security selection is set as 'On', any access from the device which connects to this port will be blocked unless the MAC address of the device is included in the static MAC address table. See the segment of Static MAC Table.
- Click  to make the configuration effective.

ADVANTECH
Industrial

Open all

- [-] Main Page
- [+] System
- [-] Port
  - [-] Port Statistics
  - [-] Port Control**
  - [-] Port Trunk
  - [-] Port Mirroring
  - [-] Rate Limiting
- [+] Protocol
- [+] Security
  - [-] Factory Default
  - [-] Save Configuration
  - [-] System Reboot

## Port Control

Port	State	Negotiation	Speed	Duplex	Flow Control	Security
Port.01	Enable	Auto	1000	Full	Enable	Off
Port.02						
Port.03						
Port.04						

Port	Group ID	Type	Link	State	Negotiation	Speed Config	Duplex Actual	Flow Control Config	Flow Control Actual	Security
Port.01	N/A	1000TX	Down	Enable	Auto	1G Full	N/A	Enable	N/A	OFF
Port.02	N/A	1000TX	Down	Enable	Auto	1G Full	N/A	Enable	N/A	OFF
Port.03	N/A	1000TX	Up	Enable	Auto	1G Full	100 Full	Enable	ON	OFF
Port.04	N/A	1000TX	Down	Enable	Auto	1G Full	N/A	Enable	N/A	OFF
Port.05	N/A	mGBIC	Down	Enable	Auto	1G Full	N/A	Enable	N/A	OFF
Port.06	N/A	mGBIC	Down	Enable	Auto	1G Full	N/A	Enable	N/A	OFF
Port.07	N/A	mGBIC	Down	Enable	Auto	1G Full	N/A	Enable	N/A	OFF
Port.08	N/A	mGBIC	Down	Enable	Auto	1G Full	N/A	Enable	N/A	OFF

Figure 3.3-20 Port Control

## Port Trunk

The Link Aggregation Control Protocol (LACP) provides a standardized means for exchanging information between Partner Systems on a link to allow their Link Aggregation Control instances to reach agreement on the identity of the Link Aggregation Group to which the link belongs, move the link to that Link Aggregation Group, and enable its transmission and reception functions in an orderly manner. Link aggregation lets you group up to 4 ports into one dedicated connections. This feature can expand bandwidth to a device on the network. **LACP operation requires full-duplex mode**, for more detail information please refer to IEEE 802.3ad.

### Aggregator setting

- **System Priority:** A value which is used to identify the active LACP. The switch with the lowest value has the highest priority and is selected as the active LACP.
- **Group ID:** There are four trunk groups to be selected. Choose the 'Group ID' and click **Select**.
- **LACP:** When enabled, the trunk group is using LACP. A port which joins an LACP trunk group has to make an agreement with its member ports first. When disabled, the trunk group is a static trunk group. The advantage of having the LACP disabled is that a port joins the trunk group without any handshaking with its member ports. But member ports won't know that they should be aggregated together to form a logic trunk group.
- **Work ports:** This column field allows the user to type in the total number of active port up to four. With LACP trunk group, you create a trunk group by connecting two or more switches (e.g. you assign four ports to be the members of a trunk group whose work ports column field is set as two). The exceed ports are standby (the **Aggregator Information** tab will show standby status on the exceed ports) and can be aggregated if work ports fail. If it is a static trunk group, the number of work ports must equal the total number of group member ports.
- Select the ports to join the trunk group. The system allows four ports maximum to be aggregated in a trunk group. Click **Add** to add the port which is focused to the left field. To remove unwanted ports, select the port and click **Remove**.
- When LACP enabled, you can configure LACP Active/Passive status for each port on State Activity page.
- Click **Apply**.
- Use **Apply** to delete Trunk Group. Select the Group ID and click **Delete**.

The screenshot displays the 'Port Trunk - Aggregator Setting' configuration interface. On the left is a navigation tree with categories like System, Port, Protocol, and Security. The main area has three tabs: 'Aggregator Setting', 'Aggregator Information', and 'State Activity'. The 'Aggregator Setting' tab is selected and contains the following configuration fields:

- System Priority:** A text input field containing the value '1'.
- Group ID:** A dropdown menu showing 'Trunk.1' and a 'Select' button.
- LACP:** A dropdown menu showing 'Disable'.
- Work Ports:** A text input field containing the value '2'.

Below the 'Work Ports' field, there are two columns of port selection:

- Left Column:** A list box containing 'Port.01' and 'Port.02'.
- Right Column:** A list box containing 'Port.03', 'Port.04', 'Port.05', 'Port.06', 'Port.07', and 'Port.08'.

Between these two columns are two buttons: '<<Add' and 'Remove>>'. At the bottom of the configuration area, there are three buttons: 'Apply', 'Delete', and 'Help'.

Figure 3.3-21 Aggregator Setting



## Aggregator Information

When you have set up the aggregator setting with LACP disabled, you will see the local static trunk group information as below.

**System Priority**  
1

<b>Group ID</b>	Trunk.1	Select
<b>Lacp</b>	Disable	
<b>Work Ports</b>	2	
Port.01 Port.08	<<Add Remove>>	Port.02 Port.03 Port.04 Port.05 Port.06 Port.07 Port.09 Port.10 Port.11

Apply Delete Help

Notice: The trunk function do not support GVRP and X-Ring.

Figure 3.3-22 2 work ports with LACP disabled

Static Trunking Group	
Group Key	1
Port Member	1 8

Figure 3.3-23 Static trunking group of 2 ports

When you have set up the aggregator setting of two interconnected switches with LACP enabled, you will see the respective LACP trunk group information as below.

The screenshot shows the ADVANTECH Industrial S... web interface. The main title is "Port Trunk - Aggregator Information". There are three tabs: "Aggregator Setting", "Aggregator Information" (which is selected), and "State Activity". On the left is a navigation menu with categories like System, Port, Protocol, and Security. The "Aggregator Information" tab displays a table for "Group 1" with the following data:

Group 1						
Actor				Partner		
<b>Priority</b>	1			1		
<b>MAC</b>	00FF3837465C			001122334422		
PortNo	Key	Priority	Active	PortNo	Key	Priority
PORT8	513	1	selected	PORT4	513	1
PORT1	513	1	selected	PORT2	513	1

Figure 3.3-24 Aggregator Information

## State Activity

Having set up the LACP aggregator on the tab of Aggregator Setting, you can configure the state activity for the members of the LACP trunk group. You can tick or cancel the checkbox beside the state display. When you remove the tick mark to the port and click  , the port state activity will change to **Passive**.

- **Active:** The port automatically sends LACP protocol packets.
- **Passive:** The port does not automatically send LACP protocol packets, and responds only if it receives LACP protocol packets from the opposite device.

*Note*                      **A link** having either two active LACP nodes or one active node can perform dynamic LACP trunk.  
**A link** having two passive LACP nodes will not perform dynamic LACP trunk because both ports are waiting for an LACP protocol packet from the opposite device.

Port	LACP State Activity	Port	LACP State Activity
1	<input checked="" type="checkbox"/> Active	2	N/A
3	N/A	4	N/A
5	N/A	6	N/A
7	N/A	8	<input checked="" type="checkbox"/> Active
9	N/A	10	N/A

Figure 3.3-25 State Activity

## Port Mirroring

The Port mirroring is a method for monitoring traffic in switched networks. Traffic through ports can be monitored by one specific port which means traffic goes in or out monitored (source) ports will be duplicated into the mirroring (destination) port.

- **Destination Port:** There is only one port can be selected to be the destination (mirroring) port for monitoring both RX and TX traffic which come from the source port. Or, use one of two ports for monitoring RX traffic only and the other one for TX traffic only. The user can connect the mirroring port to LAN analyzer or Netxray.
- **Source Port:** The ports that the user wants to monitor. All monitored port traffic will be copied to mirroring (destination) port. The user can select multiple source ports by ticking the **RX** or **TX** checkboxes to be monitored.
- And then, click .

	Destination Port		Source Port	
	RX	TX	RX	TX
Port.01	<input checked="" type="radio"/>	<input checked="" type="radio"/>	<input type="checkbox"/>	<input type="checkbox"/>
Port.02	<input type="radio"/>	<input type="radio"/>	<input type="checkbox"/>	<input type="checkbox"/>
Port.03	<input type="radio"/>	<input type="radio"/>	<input type="checkbox"/>	<input type="checkbox"/>
Port.04	<input type="radio"/>	<input type="radio"/>	<input type="checkbox"/>	<input type="checkbox"/>
Port.05	<input type="radio"/>	<input type="radio"/>	<input type="checkbox"/>	<input type="checkbox"/>
Port.06	<input type="radio"/>	<input type="radio"/>	<input type="checkbox"/>	<input type="checkbox"/>
Port.07	<input type="radio"/>	<input type="radio"/>	<input type="checkbox"/>	<input type="checkbox"/>
Port.08	<input type="radio"/>	<input type="radio"/>	<input type="checkbox"/>	<input type="checkbox"/>

Figure 3.3-26 Port Mirroring

## Rate Limiting

Here you can set up every port's frame limitation type and bandwidth rate.

- **Ingress Limit Frame type:** Select the frame type you want to filter. The frame types have 4 options for selecting: **All**, **Broadcast/Multicast/Flooded Unicast**, **Broadcast/Multicast**, and **Broadcast only**. The four frame type options are for ingress frames limitation. The egress rate only supports 'All' type.

All ports support port ingress and egress rate control. For example, assume port 1 is 10Mbps; the user can set the effective egress rate of port 1 as 1Mbps, ingress rate 500Kbps. The switch performs the ingress rate by packet counter to meet the specified rate

- **Ingress:** Enter the port effective ingress rate (The default value is "0")
- **Egress:** Enter the port effective egress rate (The default value is "0")
- And then, click  to have the settings take effect.

**ADVANTECH** Industrial

### Rate Limiting

	Ingress Limit Frame Type	Ingress	Egress
Port.01	All	0 kbps	0 kbps
Port.02	All	0 kbps	0 kbps
Port.03	All	0 kbps	0 kbps
Port.04	All	0 kbps	0 kbps
Port.05	All	0 kbps	0 kbps
Port.06	All	0 kbps	0 kbps
Port.07	All	0 kbps	0 kbps
Port.08	All	0 kbps	0 kbps

Rate Range is from 100 kbps to 102400 kbps or to 256000 kbps for giga ports, and zero means no limit.

Figure 3.3-27 Rate Limiting

### 3.3.3 Protocol

The user can set the layer 2 protocol setting via this interface.

#### VLAN configuration

A Virtual LAN (VLAN) is a logical network grouping that limits the broadcast domain, which would allow you to isolate network traffic, so only the members of the same VLAN will receive traffic from the ones of the same VLAN. Basically, creating a VLAN from a switch is logically equivalent of reconnecting a group of network devices to another Layer 2 switch. However, all the network devices are still plugged into the same switch physically.

The switch supports **Port-based** and **802.1Q** (tagged-based) VLAN. The default configuration of VLAN operation mode is “**Disable**”.

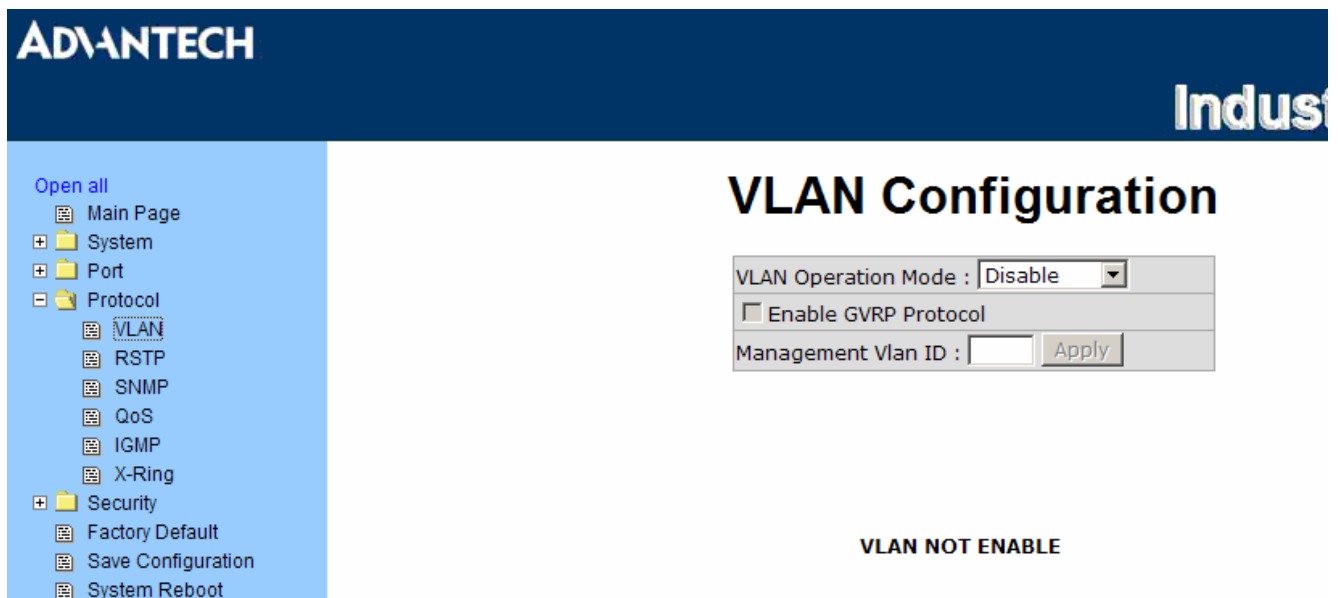

Figure 3.3-28 VLAN Configuration

## VLAN configuration - Port-based VLAN

Packets can go among only members of the same VLAN group. Note all unselected ports are treated as belonging to another single VLAN. If the port-based VLAN enabled, the VLAN-tagging is ignored.

In order for an end station to send packets to different VLAN groups, it itself has to be either capable of tagging packets it sends with VLAN tags or attached to a VLAN-aware bridge that is capable of classifying and tagging the packet with different VLAN ID based on not only default PVID but also other information about the packet, such as the protocol.

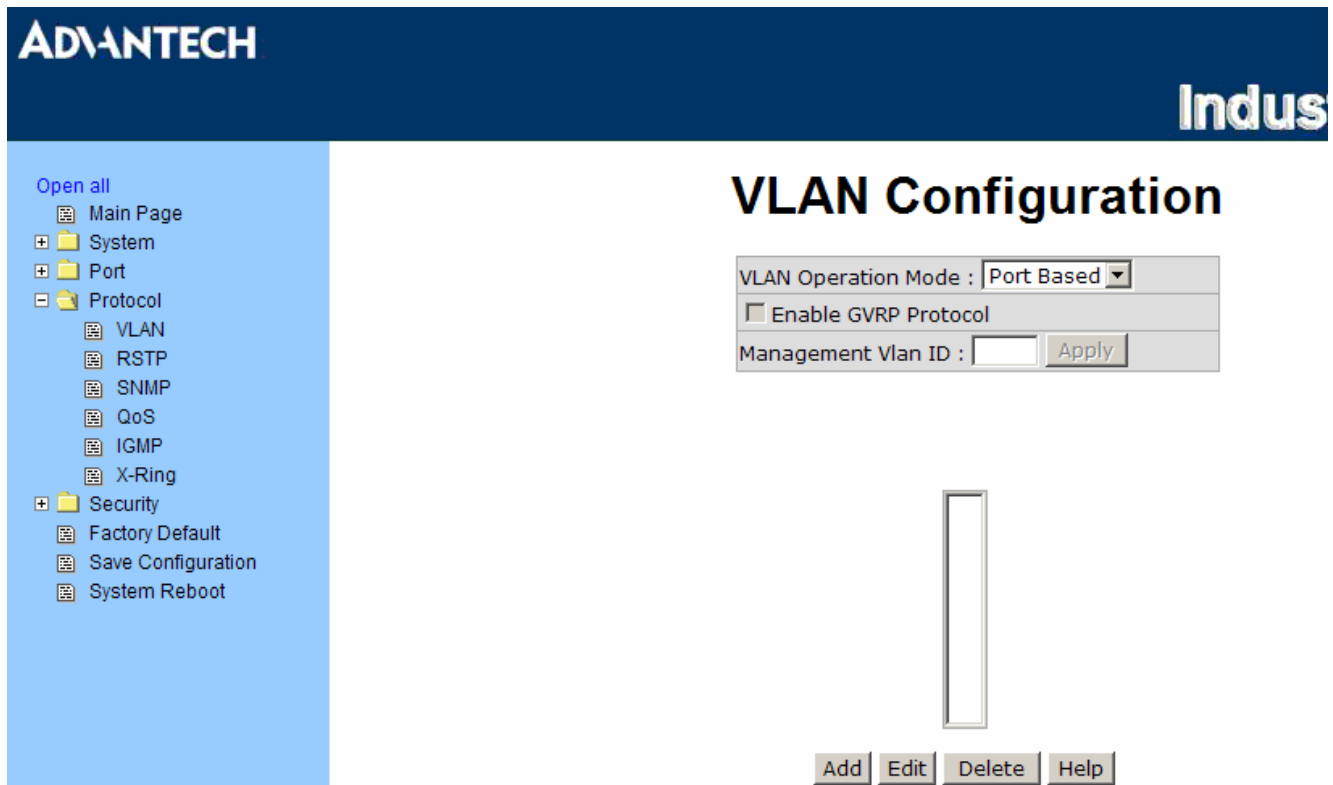

Figure 3.3-29 Port based mode

- Pull down the selection item and focus on **Port Based** then click **Apply** to set the VLAN Operation Mode in **Port Based** mode.
- Click **Add** to add a new VLAN group.

Open all

- ☰ Main Page
- + System
- + Port
- Protocol
  - ☰ VLAN
  - ☰ RSTP
  - ☰ SNMP
  - ☰ QoS
  - ☰ IGMP
  - ☰ X-Ring
- + Security
- ☰ Factory Default
- ☰ Save Configuration
- ☰ System Reboot

## VLAN Configuration

VLAN Operation Mode :

Enable GVRP Protocol

Management Vlan ID :

<b>Group Name</b>	<input type="text"/>	
<b>VLAN ID</b>	<input type="text" value="1"/>	
Port.01 Port.02 Port.03 Port.04 Port.05 Port.06 Port.07 Port.08	<input type="button" value="Add"/>	<input type="button" value="Remove"/>

Figure 3.3-30 Port based mode-Add interface

- Enter the group name and VLAN ID. Add the port number having selected into the right field to group these members to be a VLAN group or remove any of them listed in the right field from the VLAN.
- And then, click  to have the settings taken effect.
- You will see the VLAN displays.



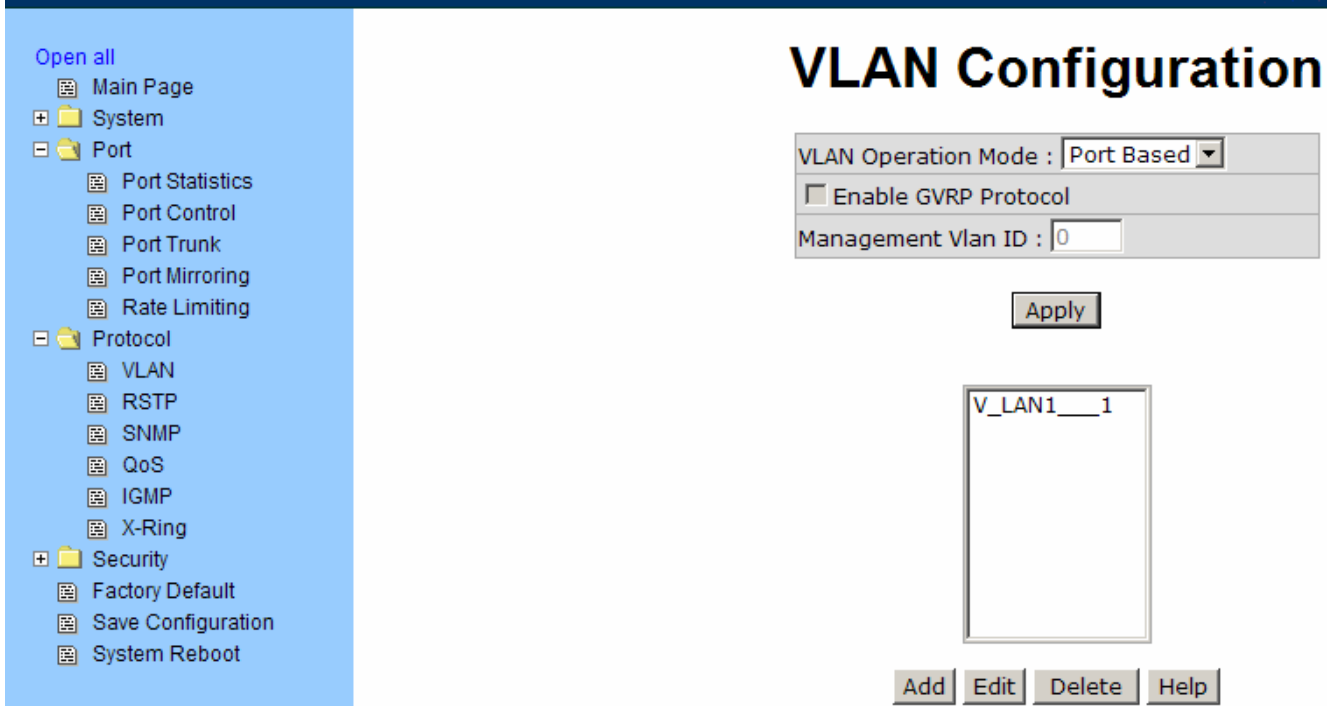

Figure 3.3-31 Port Based Edit/Delete interface

- Use **Delete** to delete the VLAN.
- Use **Edit** to modify group name, VLAN ID, or add/remove the members of the existing VLAN group.

*Note* Remember to execute the **“Save Configuration”** action, otherwise the new configuration will lose when switch power off.

## 802.1Q VLAN

Tagged-based VLAN is an IEEE 802.1Q specification standard. Therefore, it is possible to create a VLAN across devices from different switch vendors. IEEE 802.1Q VLAN uses a technique to insert a “tag” into the Ethernet frames. Tag contains a VLAN Identifier (VID) that indicates the VLAN numbers.

You can create Tag-based VLAN, and enable or disable GVRP protocol. There are 256 VLAN groups to provide configuration. Enable 802.1Q VLAN, all ports on the switch belong to default VLAN of VID 1. The default VLAN can't be deleted.

GVRP (GARP VLAN Registration Protocol) is a protocol that facilitates control of virtual local area networks (VLANs) within a larger network. GVRP conforms to the IEEE 802.1Q specification, which defines a method of tagging frames with VLAN configuration data. This allows network devices to dynamically exchange VLAN configuration information with other devices.

GVRP is based on GARP (Generic Attribute Registration Protocol), a protocol that defines procedures by which end stations and switches in a local area network (LAN) can register and de-register attributes, such as identifiers or addresses, with each other.

Every end station and switch thus has a current record of all the other end stations and switches that can be reached.

## 802.1Q Configuration

- Pull down the selection item and focus on **802.1Q** then press **Apply** to set the VLAN Operation Mode in **802.1Q** mode.
- **Enable GVRP Protocol:** Tick the checkbox to enable GVRP protocol. This checkbox is available while the VLAN Operation Mode is in **802.1Q** mode.
- **Management VLAN ID:** The default is “0” which means VLAN function in 802.1Q mode is not available. While this column field is filled with a value from 1 to 4096, the member ports of this VLAN can access the management interface.
- Select the port you want to configure.
- **Link Type:** there are 3 types of link type.
  - **Access Link:** Single switch only, it allows the user to group ports by assigning the same Untagged VID. While this link type is set, the Untagged VID column field is available but the Tagged VID column field is disabled.
  - **Trunk Link:** The extended application of **Access Link**. It allows the tagged frames go across two or more switches by assigning the tag with VID to the frames. Having set this link type, the Tagged VID column field is available but the Untagged VID column field is disabled.
  - **Hybrid Link:** Both Access Link and Trunk Link are available.
- **Untagged VID:** Assign the untagged frame VID.
- **Tagged VID:** Assign the tagged frame VID.
- Click **Apply** to have the settings taken effect.

Open all

- [-] Main Page
- [+] System
- [+] Port
- [-] Protocol
  - [+] VLAN
  - [+] RSTP
  - [+] SNMP
  - [+] QoS
  - [+] IGMP
  - [+] X-Ring
- [+] Security
  - [+] Factory Default
  - [+] Save Configuration
  - [+] System Reboot

## VLAN Configuration

VLAN Operation Mode : 802.1Q

Enable GVRP Protocol

Management Vlan ID : 0

Apply

**802.1Q Configuration**      Group Configuration

Port	Link Type	Untagged Vid	Tagged Vid
Port.01	Access Link	1	

Apply    Help

Port	Link Type	Untagged Vid	Tagged Vid
Port.01	Access Link	3	
Port.02	Access Link	3	
Port.03	Access Link	3	
Port.04	Access Link	3	
Port.05	Trunk Link	1	7,
Port.06	Trunk Link	1	7,
Port.07	Hybrid Link	1	1024,
Port.08	Hybrid Link	1	1024,

Figure 3.3-32 802.1Q VLAN Configuration

## Group Configuration

Edit the existing VLAN Group.

- Select the VLAN group in the table list.
- Click .

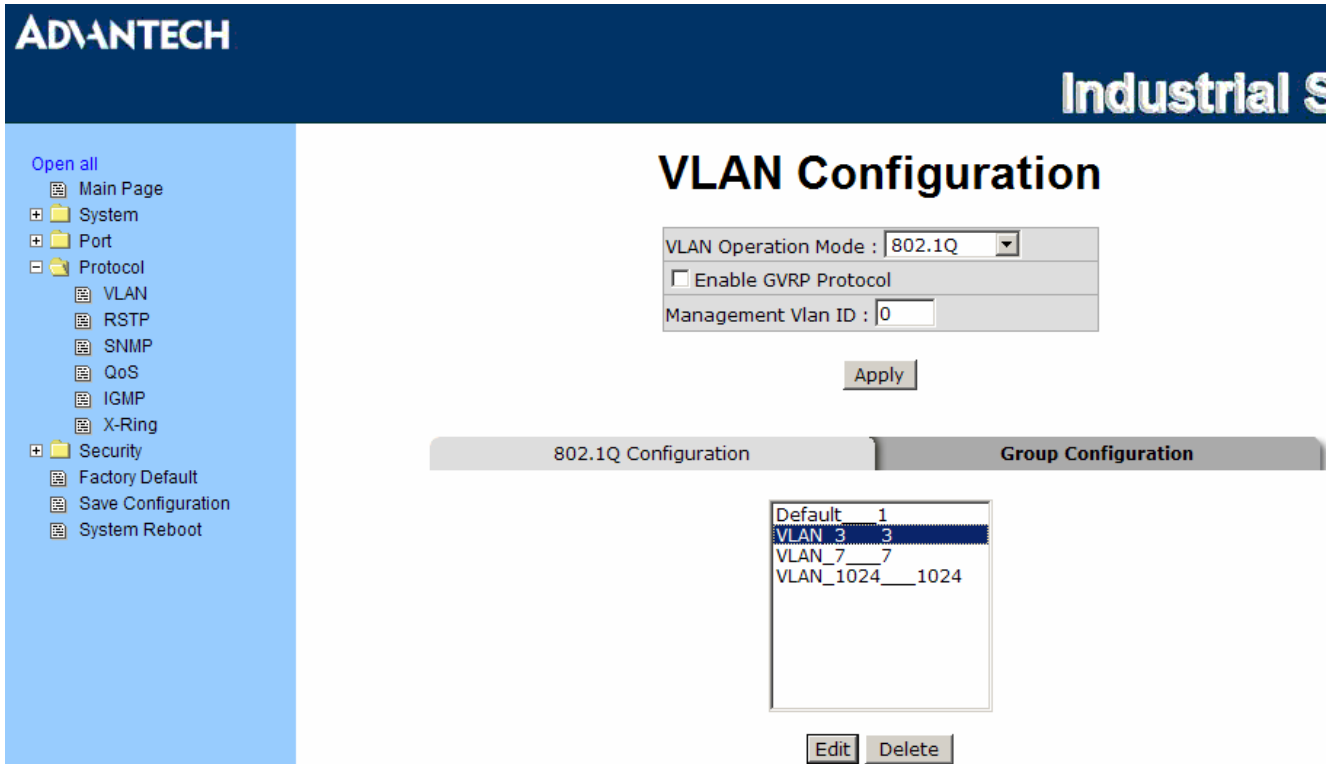

**ADVANTECH** Industrial S

Open all

- Main Page
- System
- Port
- Protocol
  - VLAN
  - RSTP
  - SNMP
  - QoS
  - IGMP
  - X-Ring
- Security
  - Factory Default
  - Save Configuration
  - System Reboot

### VLAN Configuration

VLAN Operation Mode : 802.1Q

Enable GVRP Protocol

Management Vlan ID : 0

Apply

802.1Q Configuration | **Group Configuration**

Default	1
VLAN_3	3
VLAN_7	7
VLAN_1024	1024

Edit Delete

Figure 3.3-33 Edit Group Configuration interface

- You can Change the VLAN group name and VLAN ID.

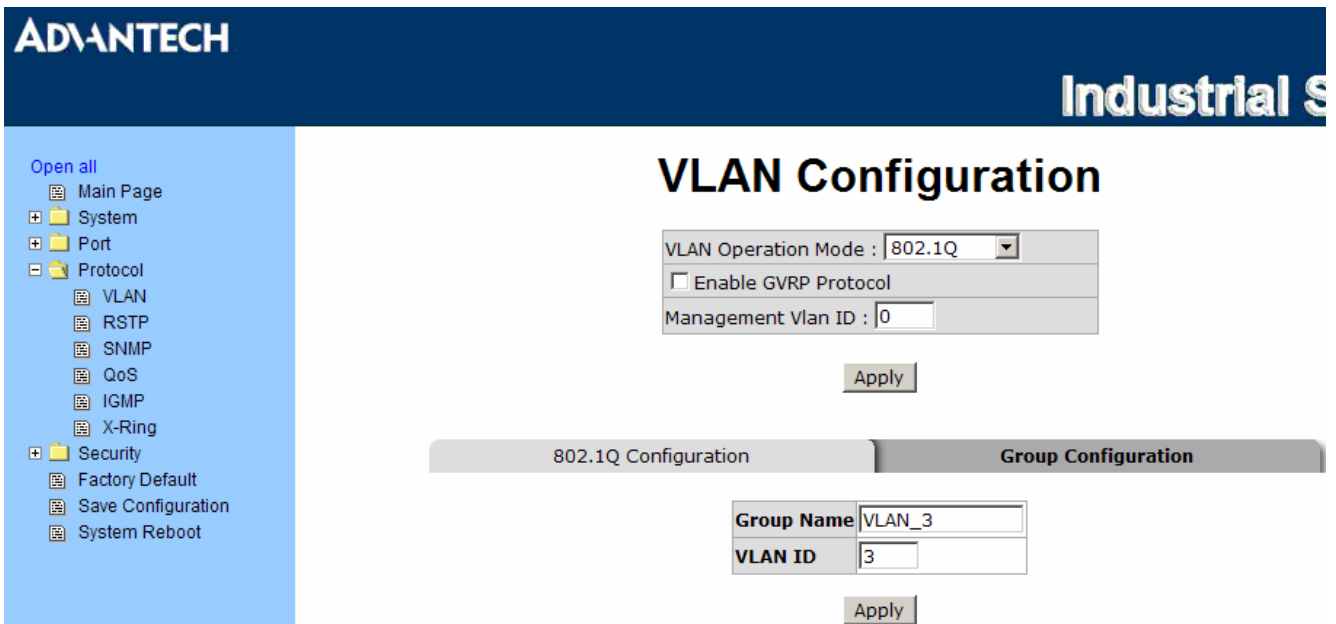

**ADVANTECH** Industrial S

Open all

- Main Page
- System
- Port
- Protocol
  - VLAN
  - RSTP
  - SNMP
  - QoS
  - IGMP
  - X-Ring
- Security
  - Factory Default
  - Save Configuration
  - System Reboot

### VLAN Configuration

VLAN Operation Mode : 802.1Q

Enable GVRP Protocol

Management Vlan ID : 0

Apply

802.1Q Configuration | **Group Configuration**

Group Name: VLAN\_3

VLAN ID: 3

Apply

Figure 3.3-34 802.1Q Group Configuration-Edit

- Click Apply.

## Rapid Spanning Tree

The Rapid Spanning Tree Protocol (RSTP) is an evolution of the Spanning Tree Protocol and provides for faster spanning tree convergence after a topology change. The system also supports STP and the system will auto-detect the connected device that is running STP or RSTP protocol.

### RSTP - System Configuration

- The user can view spanning tree information of the Root Bridge.
- The user can modify RSTP state. After modification, click **Apply**.
  - **RSTP mode:** The user must enable the RSTP function first before configuring the related parameters.
  - **Priority (0-61440):** The switch with the lowest value has the highest priority and is selected as the root. If the value is changed, the user must reboot the switch. The value must be a multiple of 4096 according to the protocol standard rule.
  - **Max Age (6-40):** The number of seconds a switch waits without receiving Spanning-tree Protocol configuration messages before attempting a reconfiguration. Enter a value between 6 through 40.
  - **Hello Time (1-10):** The time that controls the switch to send out the BPDU packet to check RSTP current status. Enter a value between 1 through 10.
  - **Forward Delay Time (4-30):** The number of seconds a port waits before changing from its Rapid Spanning-Tree Protocol learning and listening states to the forwarding state. Enter a value between 4 through 30.

*Note* Follow the rule to configure the MAX Age, Hello Time, and Forward Delay Time.  
 $2 \times (\text{Forward Delay Time value} - 1) \geq \text{Max Age value} \geq 2 \times (\text{Hello Time value} + 1)$

**ADVANTECH** Industrial S

### RSTP - System Configuration

System Configuration | Port Configuration

RSTP Mode	Enable
Priority (0-61440)	32768
Max Age (6-40)	20
Hello Time (1-10)	2
Forward Delay Time (4-30)	15

Priority must be a multiple of 4096  
 $2 * (\text{Forward Delay Time} - 1)$  should be greater than or equal to the Max Age.  
 The Max Age should be greater than or equal to  $2 * (\text{Hello Time} + 1)$ .

Apply Help

#### Root Bridge Information

Bridge ID	008000FF3837465C
Root Priority	32768
Root Port	Root
Root Path Cost	0
Max Age	20
Hello Time	2
Forward Delay	15

Figure 3.3-35 RSTP System Configuration interface

## RSTP - Port Configuration

Here you can configure the path cost and priority of each port.

- Select the port in the port column field.
- **Path Cost:** The cost of the path to the other bridge from this transmitting bridge at the specified port. Enter a number 1 through 200,000,000.
- **Priority:** Decide which port should be blocked by priority in LAN. Enter a number 0 through 240 (the port of the highest value will be blocked). The value of priority must be the multiple of 16.
- **Admin P2P:** Some of the rapid state transactions that are possible within RSTP are dependent upon whether the port concerned can only be connected to exactly one other bridge (i.e. it is served by a point-to-point LAN segment), or can be connected to two or more bridges (i.e. it is served by a shared medium LAN segment). This function allows the P2P status of the link to be manipulated administratively. True is P2P enabling. False is P2P disabling.
- **Admin Edge:** The port directly connected to end stations won't create bridging loop in the network. To configure the port as an edge port, set the port to "True" status.
- **Admin Non Stp:** The port includes the STP mathematic calculation. **True** is not including STP mathematic calculation. **False** is including the STP mathematic calculation.
- Click  .

**ADVANTECH** Industrial S

### RSTP - Port Configuration

System Configuration | **Port Configuration**

Port	Path Cost (1-200000000)	Priority (0-240)	Admin P2P	Admin Edge	Admin Non Stp
Port.01					
Port.02					
Port.03	200000	128	Auto	true	false
Port.04					
Port.05					

priority must be a multiple of 16

#### RSTP Port Status

Port	Path Cost	Port Priority	Oper P2P	Oper Edge	Stp Neighbor	State	Role
Port.01	200000	128	True	True	False	Disabled	Disabled
Port.02	200000	128	True	True	False	Disabled	Disabled
Port.03	200000	128	True	True	False	Forwarding	Designated
Port.04	200000	128	True	True	False	Disabled	Disabled
Port.05	200000	128	True	True	False	Disabled	Disabled
Port.06	200000	128	True	True	False	Disabled	Disabled
Port.07	200000	128	True	True	False	Disabled	Disabled
Port.08	200000	128	True	True	False	Disabled	Disabled

Figure 3.3-36 RSTP Port Configuration interface

## SNMP Configuration

Simple Network Management Protocol (SNMP) is the protocol developed to manage nodes (servers, workstations, routers, switches and hubs etc.) on an IP network. SNMP enables network administrators to manage network performance, find and solve network problems, and plan for network growth. Network management systems learn of problems by receiving traps or change notices from network devices implementing SNMP.

## System Configuration

### Community Strings

Here you can define the new community string set and remove the unwanted community string.

- **String:** Fill the name string.
- **RO:** Read only. Enables requests accompanied by this community string to display MIB-object information.
- **RW:** Read write. Enables requests accompanied by this community string to display MIB-object information and to set MIB objects.
- Click **Add**.
- To remove the community string, select the community string that you have defined and click **Remove**. You cannot edit the name of the default community string set.

### Agent Mode

Select the SNMP version that you want to use and then click **Change** to switch to the selected SNMP version mode. The default value is 'SNMP v1/v2c only'

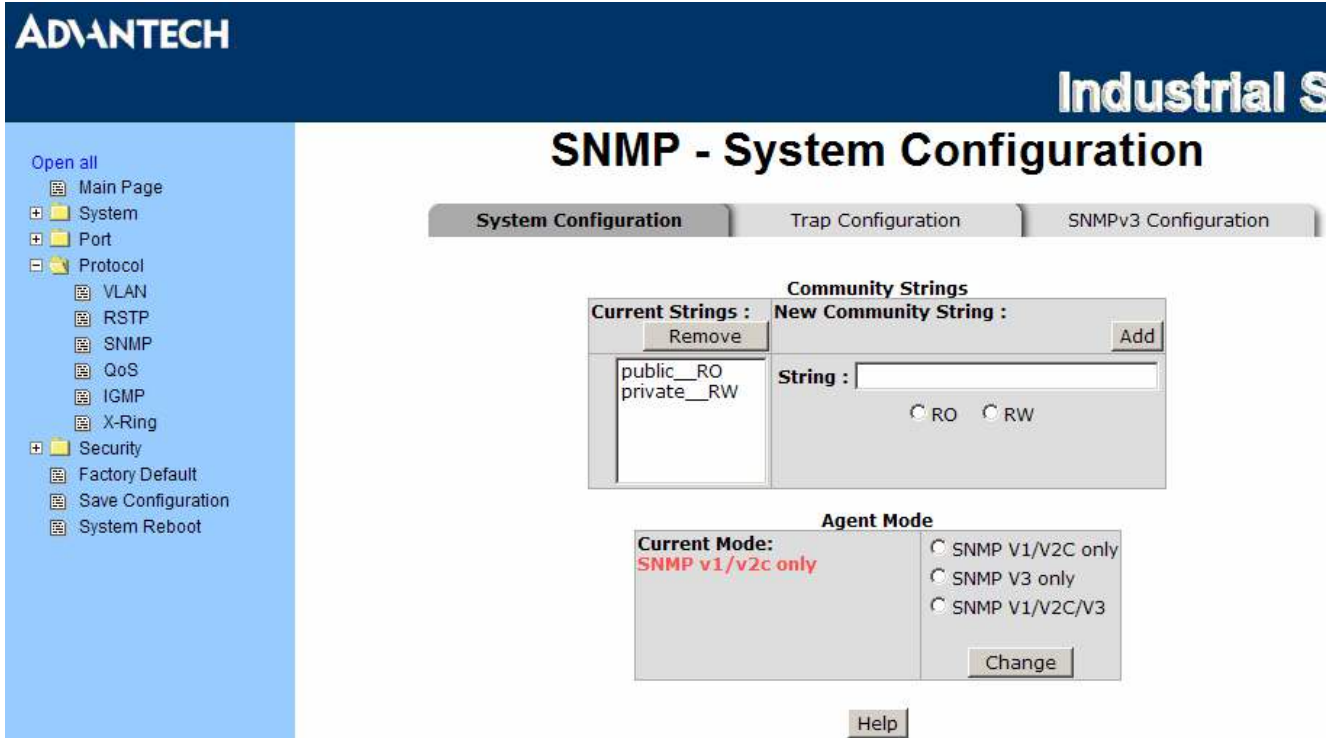

Figure 3.3-37 SNMP System Configuration interface

## Trap Configuration

A trap manager is a management station that receives the trap messages generated by the switch. If no trap manager is defined, no traps will be issued. Create a trap manager by entering the IP address of the station and a community string. To define a management station as a trap manager, assign an IP address, enter the SNMP community strings, and select the SNMP trap version.

- **IP Address:** Enter the IP address of the trap manager.
- **Community:** Enter the community string.
- **Trap Version:** Select the SNMP trap version type—v1 or v2c.
- Click **Add**.
- To remove the community string, select the community string listed in the current managers field and click **Remove**.

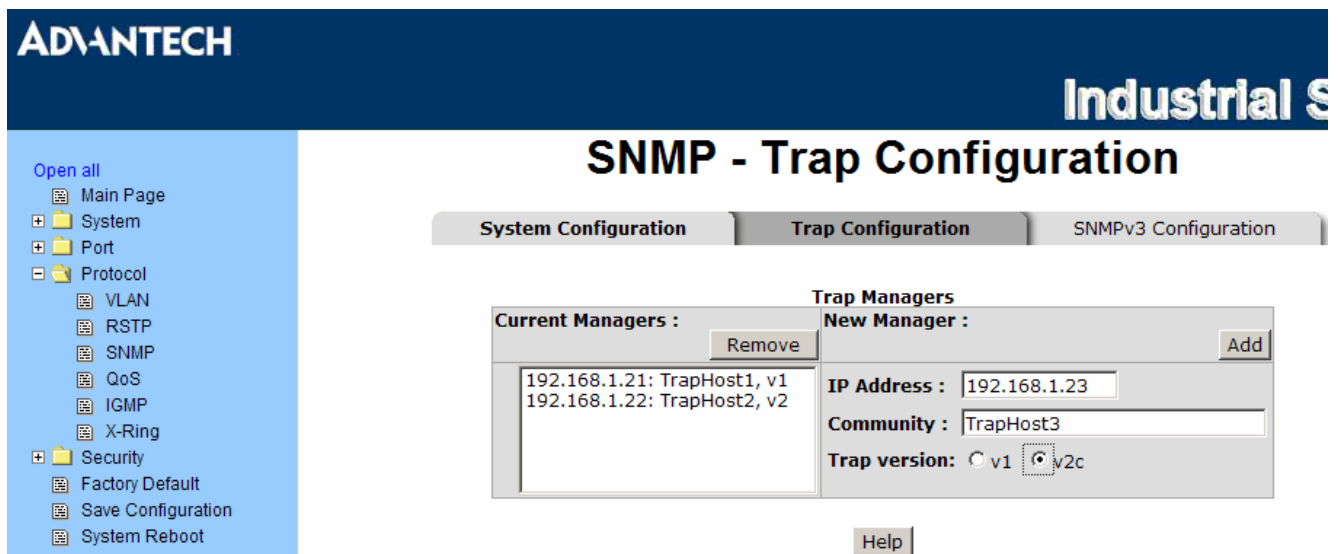

Figure 3.3-38 Trap Configuration interface



## SNMPV3 Configuration

Configure the SNMP V3 function.

### Context Table

Configure SNMP v3 context table. Assign the context name of context table. Click **Apply** to add context name.

### User Table

Configure SNMP v3 user table..

- **User ID:** Set up the user name.
- **Authentication Password:** Set up the authentication password.
- **Privacy Password:** Set up the private password.
- Click **Add** to add context name.
- Click **Remove** to remove unwanted context name.

### Group Table

Configure SNMP v3 group table.

- **Security Name (User ID):** Assign the user name that you have set up in user table.
- **Group Name:** Set up the group name.
- Click **Add** to add context name.
- Click **Remove** to remove the unwanted context name.

### Access Table

Configure SNMP v3 access table.

- **Context Prefix:** Set up the context name.
- **Group Name:** Set up the group.
- **Security Level:** Set up the access level.
- **Context Match Rule:** Select the context match rule.
- **Read View Name:** Set up the read view.
- **Write View Name:** Set up the write view.
- **Notify View Name:** Set up the notify view.
- Click **Add** to add context name.
- Click **Remove** to remove unwanted context name.

### MIBview Table

Configure MIB view table.

- **ViewName:** Set up the name.
- **Sub-Oid Tree:** Fill the Sub OID.
- **Type:** Select the type—excluded or included.
- Click **Add** to add context name.
- Click **Remove** to remove unwanted context name.

# SNMP - SNMPv3 Configuration

- Open all
- [-] Main Page
- [-] System
- [-] Port
- [-] Protocol
  - [-] VLAN
  - [-] RSTP
  - [-] SNMP
  - [-] QoS
  - [-] IGMP
  - [-] X-Ring
- [-] Security
  - [-] Factory Default
  - [-] Save Configuration
  - [-] System Reboot

System Configuration    Trap Configuration    **SNMPv3 Configuration**

**Context Table**

Context Name :  Apply

**User Table**

<b>Current User Profiles :</b>	<b>New User Profile :</b>
(none) <span style="float: right;">Remove</span>	Add
	User ID: <input type="text"/>
	Authentication Password: <input type="text"/>
	Privacy Password: <input type="text"/>

**Group Table**

<b>Current Group content :</b>	<b>New Group Table:</b>
(none) <span style="float: right;">Remove</span>	Add
	Security Name (User ID): <input type="text"/>
	Group Name: <input type="text"/>

**Access Table**

<b>Current Access Tables :</b>	<b>New Access Table :</b>
(none) <span style="float: right;">Remove</span>	Add
	Context Prefix: <input type="text"/>
	Group Name: <input type="text"/>
	Security Level: <input type="radio"/> NoAuthNoPriv. <input type="radio"/> AuthNoPriv. <input type="radio"/> AuthPriv.
	Context Match Rule: <input type="radio"/> Exact <input type="radio"/> Prefix
	Read View Name: <input type="text"/>
	Write View Name: <input type="text"/>
	Notify View Name: <input type="text"/>

**MIBView Table**

<b>Current MIBTables :</b>	<b>New MIBView Table :</b>
(none) <span style="float: right;">Remove</span>	Add
	View Name: <input type="text"/>
	SubOid-Tree: <input type="text"/>
	Type: <input type="radio"/> Excluded <input type="radio"/> Included

Help

**Note:** Any modification of SNMPv3 tables might cause MIB accessing rejection. Please take notice of the causality between the tables before you modify these tables.

Figure 3.3-39 SNMP V3 Configuration interface

## QoS Configuration

Here you can configure QoS policy and priority setting, per port priority setting, COS and TOS setting.

### QoS Policy and Priority Type

- **QoS Policy:** Select the QoS policy rule.
  - **Use an 8,4,2,1 weighted fair queuing scheme:** The switch will follow 8:4:2:1 rate to process priority queue from High to lowest queue. For example, while the system processing, 1 frame of the lowest queue, 2 frames of the low queue, 4 frames of the middle queue, and 8 frames of the high queue will be processed at the same time in accordance with the 8,4,2,1 policy rule.
  - **Use a strict priority scheme:** Always the higher queue will be processed first, except the higher queue is empty.
  - **Priority Type:** There are 5 priority type selections available—**Port-based**, **TOS only**, **COS only**, **TOS first**, and **COS first**. Disable means no priority type is selected.
- Click  to have the settings take effect.

### Port Base Priority

Configure the priority level for each port. With the drop-down selection item of **Priority Type** above being selected as Port-based, this control item will then be available to set the queuing policy for each port.

- **Port x:** Each port has 4 priority levels—High, Middle, Low, and Lowest—to be chosen.
- Click  to have the settings taken effect.

### COS Configuration

Set up the COS priority level. With the drop-down selection item of **Priority Type** above being selected as COS only/COS first, this control item will then be available to set the queuing policy for each port.

- **COS priority:** Set up the COS priority level 0~7—High, Middle, Low, Lowest.
- Click .

### TOS Configuration

Set up the TOS priority. With the drop-down selection item of **Priority Type** above being selected as TOS only/TOS first, this control item will then be available to set the queuing policy for each port.

- **TOS priority:** The system provides 0~63 TOS priority level. Each level has 4 types of priority—High, Middle, Low, and Lowest. The default value is 'Lowest' priority for each level. When the IP packet is received, the system will check the TOS level value in the IP packet that has received. For example, the user sets the TOS level 25 as high, the system will check the TOS value of the received IP packet. If the TOS value of received IP packet is 25 (priority = high), and then the packet priority will have highest priority.
- Click  to have the settings take effect.

## QoS Configuration

Open all

- [-] Main Page
- [-] System
- [-] Port
- [-] Protocol
  - [-] VLAN
  - [-] RSTP
  - [-] SNMP
  - [-] QoS
  - [-] IGMP
  - [-] X-Ring
- [-] Security
  - [-] Factory Default
  - [-] Save Configuration
  - [-] System Reboot

### Qos Policy:

Use an 8,4,2,1 weighted fair queuing scheme  
 Use a strict priority scheme  
 Priority Type: Disable

### Port-based Priority:

Port.01	Port.02	Port.03	Port.04	Port.05	Port.06	Port.07	Port.08
Lowest	Lowest	Lowest	Lowest	Lowest	Lowest	Lowest	Lowest

### COS:

Priority	0	1	2	3	4	5	6	7
	Lowest	Lowest	Lowest	Lowest	Lowest	Lowest	Lowest	Lowest

### TOS:

Priority	0	1	2	3	4	5	6	7
	Lowest	Lowest	Lowest	Lowest	Lowest	Lowest	Lowest	Lowest
Priority	8	9	10	11	12	13	14	15
	Lowest	Lowest	Lowest	Lowest	Lowest	Lowest	Lowest	Lowest
Priority	16	17	18	19	20	21	22	23
	Lowest	Lowest	Lowest	Lowest	Lowest	Lowest	Lowest	Lowest
Priority	24	25	26	27	28	29	30	31
	Lowest	Lowest	Lowest	Lowest	Lowest	Lowest	Lowest	Lowest
Priority	32	33	34	35	36	37	38	39
	Lowest	Lowest	Lowest	Lowest	Lowest	Lowest	Lowest	Lowest
Priority	40	41	42	43	44	45	46	47
	Lowest	Lowest	Lowest	Lowest	Lowest	Lowest	Lowest	Lowest
Priority	48	49	50	51	52	53	54	55
	Lowest	Lowest	Lowest	Lowest	Lowest	Lowest	Lowest	Lowest
Priority	56	57	58	59	60	61	62	63
	Lowest	Lowest	Lowest	Lowest	Lowest	Lowest	Lowest	Lowest

Figure 3.3-40 QoS Configuration interface

## IGMP Configuration

The Internet Group Management Protocol (IGMP) is an internal protocol of the Internet Protocol (IP) suite. IP manages multicast traffic by using switches, routers, and hosts that support IGMP. Enabling IGMP allows the ports to detect IGMP queries, report packets, and manage IP multicast traffic through the switch. IGMP have three fundamental types of message shown as follows:

Message	Description
Query	A message sent from the querier (IGMP router or switch) asking for a response from each host belonging to the multicast group.
Report	A message sent by a host to the querier to indicate that the host wants to be or is a member of a given group indicated in the report message.
Leave Group	A message sent by a host to the querier to indicate that the host has quit being a member of a specific multicast group.

The switch supports IP multicast. You can enable IGMP protocol via setting the IGMP Configuration page to see the IGMP snooping information. IP multicast addresses are in the range of 224.0.0.0 through 239.255.255.255.

- **IGMP Protocol:** Enable or disable the IGMP protocol.
- **IGMP Query:** Select the IGMP query function as Enable or Auto to set the switch as a querier for IGMP version 2 multicast networks.
- Click  .

The screenshot displays the 'IGMP Configuration' interface. On the left, a navigation menu lists various system settings. The main area features a table with the following data:

IP Address	VLAN ID	Member Port
239.255.255.250	1	***4****

Below the table, the 'IGMP Protocol' is set to 'Enable' and 'IGMP Query' is set to 'Auto'. 'Apply' and 'Help' buttons are located at the bottom of the configuration area.

Figure 3.3-41 IGMP Configuration interface

## X-Ring

X-Ring provides a faster redundant recovery than Spanning Tree topology. The action is similar to STP or RSTP, but the algorithms between them are not the same.

In the X-Ring topology, each switch should be enabled with the X-Ring function and two ports of each switch should be configured as the member ports in the ring. Only one switch in the X-Ring group would be set as the master switch that one of its two member ports, known as backup port, would be blocked and the other port is called working port. Other switches in the X-Ring group are called working switches and their two member ports are called working ports. When the failure of network connection occurs, the backup port (blocked) of the master switch (Ring Master) will automatically become a working port to help the entire group recover from the failure.

The switch supports the function and interface to configure the switch being a ring master. The ring master can negotiate and place commands to other switches in the X-Ring group. If there are two or more switches in master mode, the software will configure the switch with lowest MAC address number as the ring master. The ring master mode can be enabled via the X-Ring configuration interface. Also, the user can identify whether the switch is the ring master by checking the corresponding LED indicator on the panel of the switch.

The system also supports the **Couple Ring** topology that can connect two X-Ring groups for the redundant backup function. Besides, the **Dual Homing** topology can prevent connection lose between the X-Ring group and the upper level/core switch.

- **Enable X-Ring:** To enable the X-Ring function, tick the checkbox beside the **Enable Ring** string label. If this checkbox is not ticked, all the ring functions are unavailable.
  - **Enable Ring Master:** Tick the checkbox to enable this switch to be the ring master.
  - **1st & 2nd Ring Ports:** Pull down the selection menu to assign the ports as the member ports. **1st Ring Port** is the working port and **2nd Ring Port** is the backup port. When **1st Ring Port** fails, the system will automatically upgrade the **2nd Ring Port** to be the working port.
- **Enable Couple Ring:** To enable the couple ring function, tick the checkbox beside the **Enable Couple Ring** string label.
  - **Couple port:** Assign the member port which is connected to the other ring group.
  - **Control port:** When the **Enable Couple Ring** checkbox is ticked, you have to assign the control port to form a couple-ring group between the two X-rings.
- **Enable Dual Homing:** Set up one of the ports on the switch to be the Dual Homing port. For a switch, there is only one Dual Homing port. Dual Homing function only works when the X-Ring function enabled.
- And then, click  to apply the configuration.

Figure 3.3-42 X-ring interface

**Note**

To enable the X-Ring function, users must disable the RSTP first. The X-Ring function and RSTP function cannot both be activated on a single switch. Remember to execute the “Save Configuration” action, otherwise the new configuration will lose when switch powers off.

### 3.3.4 Security

In this section, you can configure 802.1x and MAC address table.

#### 802.1X/Radius Configuration

802.1x is an IEEE authentication specification which prevents the client from connecting to a wireless access point or wired switch until it provides authority, like the user name and password that are verified by an authentication server (such as RADIUS server).

#### 802.1X/Radius - System Configuration

After enabling the IEEE 802.1X function, you can configure the parameters of this function.

- **IEEE 802.1x Protocol:** Enable or disable 802.1x protocol.
- **Radius Server IP:** Assign the RADIUS Server IP address.
- **Server Port:** Set the UDP destination port for authentication requests to the specified RADIUS Server.
- **Accounting Port:** Set the UDP destination port for accounting requests to the specified RADIUS Server.
- **Shared Key:** Set an encryption key for using during authentication sessions with the specified RADIUS server. This key must match the encryption key used on the RADIUS Server.
- **NAS, Identifier:** Set the identifier for the RADIUS client.
- Click  .

The screenshot displays the '802.1x/Radius - System Configuration' page. On the left is a navigation menu with options like 'Main Page', 'System', 'Port', 'Protocol', 'Security', '802.1x/Radius', 'MAC Address Table', 'Factory Default', 'Save Configuration', and 'System Reboot'. The main content area has three tabs: 'System Configuration' (selected), 'Port Configuration', and 'Misc Configuration'. Below the tabs is a configuration table with the following data:

802.1x Protocol	Enable
Radius Server IP	0.0.0.0
Server Port	1812
Accounting Port	1813
Shared Key	12345678
NAS, Identifier	NAS_L2_SWITCH

At the bottom of the configuration area are two buttons: 'Apply' and 'Help'.

Figure 3.3-43 802.1x/Radius System Configuration



## 802.1x/RADIUS - Port Configuration

You can configure the 802.1x authentication state for each port. The state provides Disable, Accept, Reject, and Authorize.

- **Reject:** The specified port is required to be held in the unauthorized state.
- **Accept:** The specified port is required to be held in the Authorized state.
- **Authorized:** The specified port is set to the Authorized or Unauthorized state in accordance with the outcome of an authentication exchange between the Supplicant and the authentication server.
- **Disable:** When disabled, the specified port works without complying with 802.1x protocol.
- Click  .

The screenshot shows the Advantech Industrial Switch configuration interface. The main title is "802.1x/RADIUS - Port Configuration". The interface is divided into three tabs: "System Configuration", "Port Configuration" (selected), and "Misc Configuration".

On the left, there is a navigation menu with the following items:

- Open all
- Main Page
- System
- Port
- Protocol
- Security
  - 802.1x/RADIUS
  - MAC Address Table
- Factory Default
- Save Configuration
- System Reboot

The main configuration area shows a table with two columns: "Port" and "State". The "Port" column contains a list of ports from Port.01 to Port.05, each with a dropdown arrow. The "State" column contains a dropdown menu currently set to "Authorize".

Below the table are two buttons: "Apply" and "Help".

Below the buttons is a table titled "Port Authorization" with two columns: "Port" and "State".

Port	State
Port.01	Disable
Port.02	Disable
Port.03	Disable
Port.04	Disable
Port.05	Disable
Port.06	Disable
Port.07	Disable
Port.08	Disable

Figure 3.3-44 802.1x/RADIUS - Port Setting

## 802.1X/Radius - Misc Configuration

- **Quiet Period:** Set the period which the port doesn't try to acquire a supplicant.
- **TX Period:** Set the period the port waits for retransmit next EAPOL PDU during an authentication session.
- **Supplicant Timeout:** Set the period of time the switch waits for a supplicant response to an EAP request.
- **Server Timeout:** Set the period of time the switch waits for a server response to an authentication request.
- **Max Requests:** Set the number of authentication that must time-out before authentication fails and the authentication session ends.
- **Reauth period:** Set the period of time which clients connected must be re-authenticated.
- Click  .

The screenshot shows the Advantech Industrial Switch configuration interface. The top navigation bar includes the Advantech logo and the text "Industrial S". The main title is "802.1x/Radius - Misc Configuration". Below the title are three tabs: "System Configuration", "Port Configuration", and "Misc Configuration", with "Misc Configuration" being the active tab. A table displays the following configuration parameters:

Quiet Period	<input type="text" value="60"/>
Tx Period	<input type="text" value="30"/>
Supplicant Timeout	<input type="text" value="30"/>
Server Timeout	<input type="text" value="30"/>
Max Requests	<input type="text" value="2"/>
Reauth Period	<input type="text" value="3600"/>

Below the table are two buttons: "Apply" and "Help". On the left side, there is a navigation menu with the following items:

- Open all
- Main Page
- System
- Port
- Protocol
- Security
  - 802.1x/Radius
  - MAC Address Table
- Factory Default
- Save Configuration
- System Reboot

Figure 3.3-45 802.1x/Radius - Misc Configuration

## MAC Address Table

Use the MAC address table to ensure the port security.

You can add a static MAC address; it remains in the switch's address table, regardless of whether the device is physically connected to the switch. This saves the switch from having to re-learn a device's MAC address when the disconnected or powered-off device is active on the network again. You can add / modify / delete a static MAC address.

### MAC Address Table - Static MAC Address

You can add static MAC address in the switch MAC table here.

- **MAC Address:** Enter the MAC address of the port that should permanently forward traffic, regardless of the device network activity.
- **Port No.:** Pull down the selection menu to select the port number.
- Click **Add**.
- If you want to delete the MAC address from filtering table, select the MAC address and click **Delete**.

The screenshot shows the ADVANTECH Industrial Switch web interface. The top navigation bar includes the ADVANTECH logo and the text 'Industrial Sw'. The main heading is 'MAC Address Table - Static MAC Addresses'. Below this heading are three tabs: 'Static MAC Addresses' (selected), 'MAC Filtering', and 'All Mac Addresses'. A table displays a single entry with the MAC address 'FFEEDDCCBBAA' and 'Port.01'. Below the table are input fields for 'MAC Address' and 'Port No.' (set to 'Port.01'). At the bottom are buttons for 'Add', 'Delete', and 'Help'. A left sidebar contains a navigation menu with options like 'Main Page', 'System', 'Port', 'Protocol', 'Security', '802.1x/RADIUS', 'MAC Address Table', 'Factory Default', 'Save Configuration', and 'System Reboot'.

Figure 3.3-46 Static MAC Addresses interface

## MAC Address Table - MAC Filtering

By filtering MAC address, the switch can easily filter the pre-configured MAC address and reduce the un-safety. You can add and delete filtering MAC address.

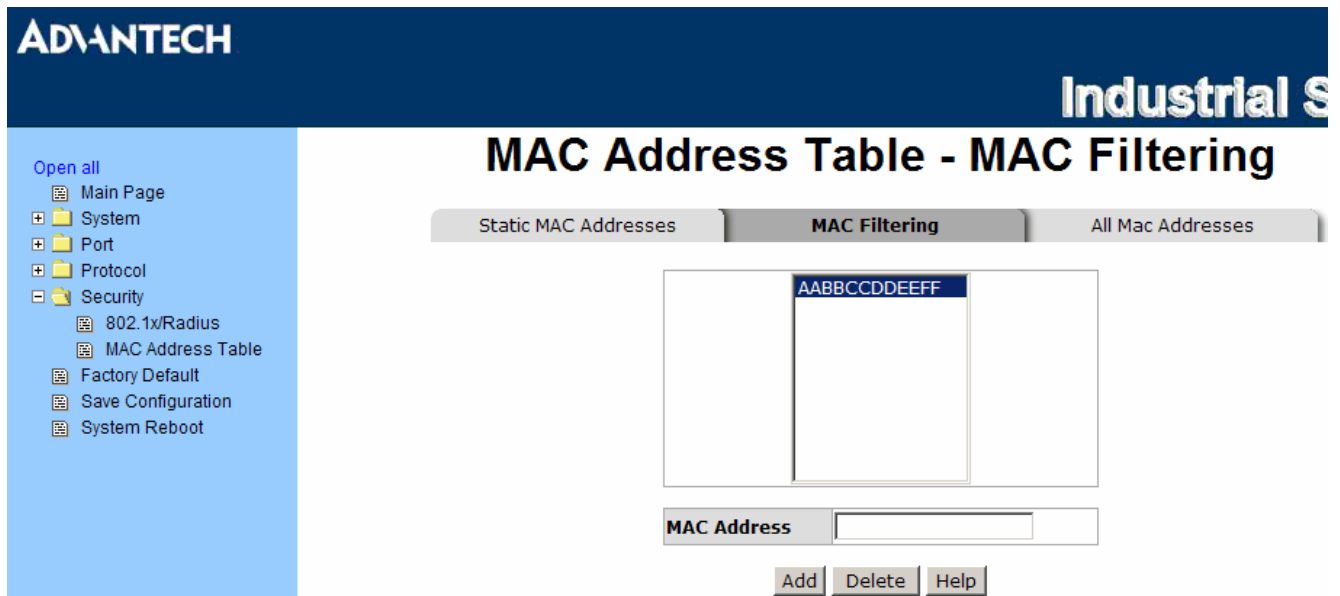

Figure 3.3-47 MAC Filtering interface

- **MAC Address:** Enter the MAC address that you want to filter.
- Click **Add**.
- If you want to delete the MAC address from filtering table, select the MAC address and click **Delete**.

## MAC Address Table - All MAC Addresses

You can view the port that connected device's MAC address and the related devices' MAC address.

- Click the pull-down menu to select a port number.
- The selected port of static & dynamic MAC address information will be displayed in here.
- Click **Clear MAC Table** to clear the current port static MAC address information on screen.

The screenshot shows the Advantech Industrial S web interface. On the left is a navigation menu with the following items: Open all, Main Page, System, Port, Protocol, Security, 802.1x/RADIUS, MAC Address Table, Factory Default, Save Configuration, and System Reboot. The main content area is titled "MAC Address Table - All Mac Addresses" and has three tabs: "Static MAC Addresses", "MAC Filtering", and "All Mac Addresses". The "All Mac Addresses" tab is active. Below the tabs is a "Port No:" dropdown menu set to "Port.01". A table displays one entry: "FFEEDDCCBBA" under the "MAC" column and "STATIC" under the "Type" column. Below the table, it shows "Dynamic Address Count:0" and "Static Address Count:1". At the bottom is a "Clear MAC Table" button.

Figure 3.3-48 All MAC Address interface

## Factory Default

Reset the switch to default configuration. Tick the check boxes to keep the current IP address, user name and password before reset. Click **Reset** to reset all configurations to the default value.



Figure 3.3-49 Factory Default interface

## Save Configuration

Save all configurations that you have made to the system. Click **Save** to save all configuration to the flash memory.

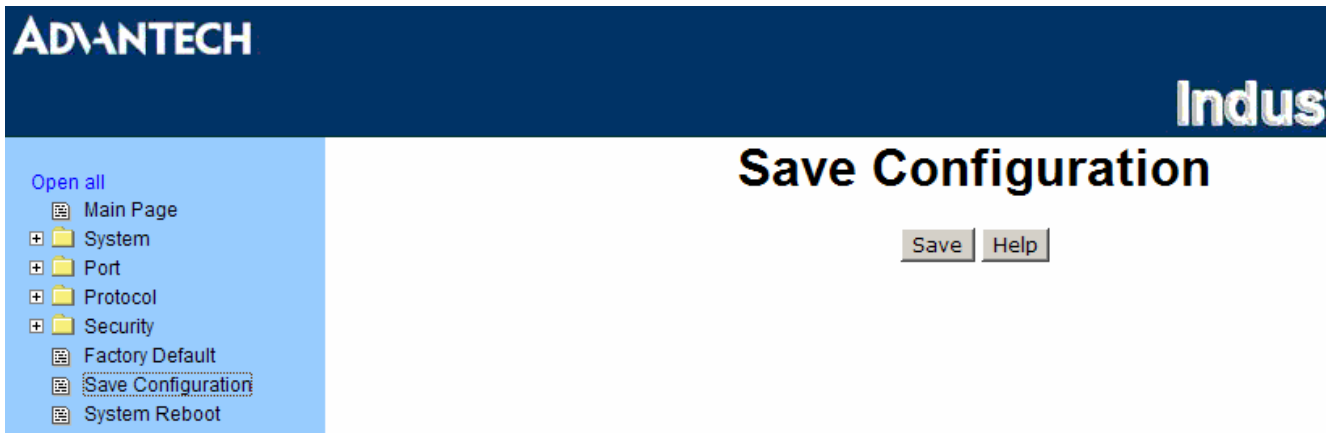

Figure 3.3-50 Save Configuration interface

## System Reboot

Reboot the switch in software reset. Click **Reboot** to reboot the system.

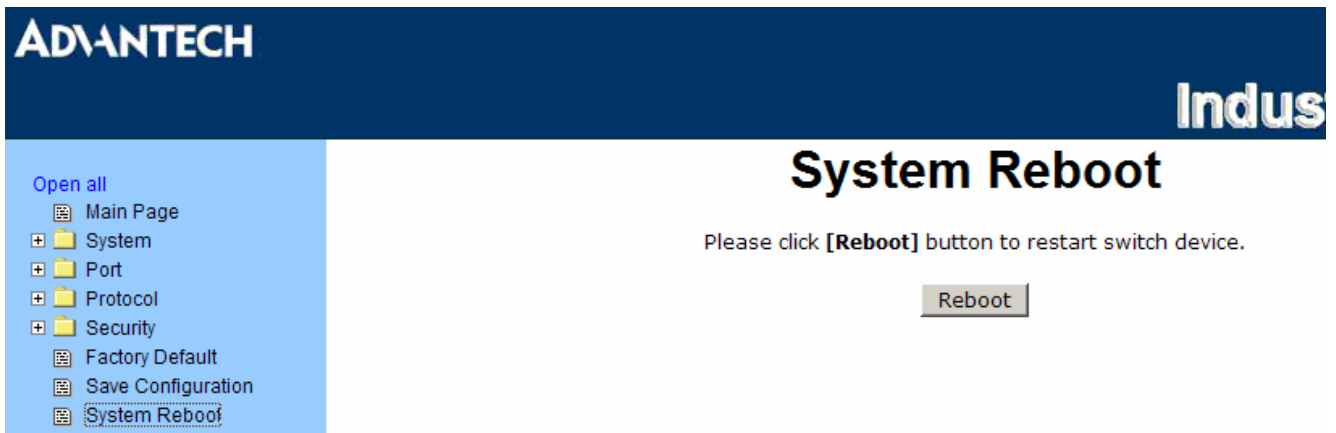

Figure 3.3-51 System Reboot interface



CHAPTER  
**4**

**Troubleshooting**

## Chapter 4 Troubleshooting

Verify that you are using the included or appropriate power cord/adaptor. Don't use the power adaptor with DC output voltage higher than the power rating of the device. Otherwise, the device will burn down.

Select the proper UTP cable to construct the network. Use unshielded twisted-pair (UTP) or shield twisted-pair (STP) cable for RJ-45 connections: 100  $\Omega$  Category 3, 4 or 5 cable for 10Mbps connections, 100  $\Omega$  Category 5 cable for 100Mbps connections, or 100  $\Omega$  Category 5e/above cable for 1000Mbps connections. Also be sure that the length of any twisted-pair connection does not exceed 100 meters (328 feet).

### Diagnosing LED Indicators

To assist in identifying problems, the switch can be easily monitored through panel indicators, which describe common problems the user may encounter and where the user can find possible solutions.

If the power indicator does not light on when the power cord is plugged in, you may have a problem with power cord. Then check for loose power connections, power losses or surges at power outlet. If you still cannot resolve the problem, contact the local dealer for assistance.

If the LED indicators are normal and the connected cables are correct but the packets still cannot be transmitted, please check the Ethernet devices' configuration or status of the system.

**APPENDIX  
A**

**Pin Assignments &  
Wiring**

# Appendix A Pin Assignments & Wiring

It is suggested to adopt ELA/TIA as the wiring of the RJ-45.

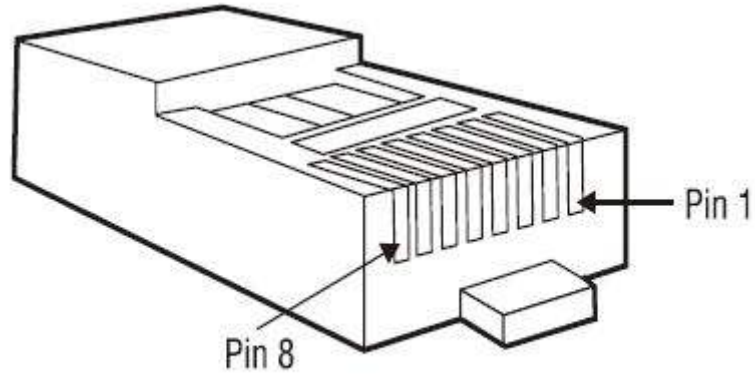

Figure A.1: RJ-45 Pin Assignments

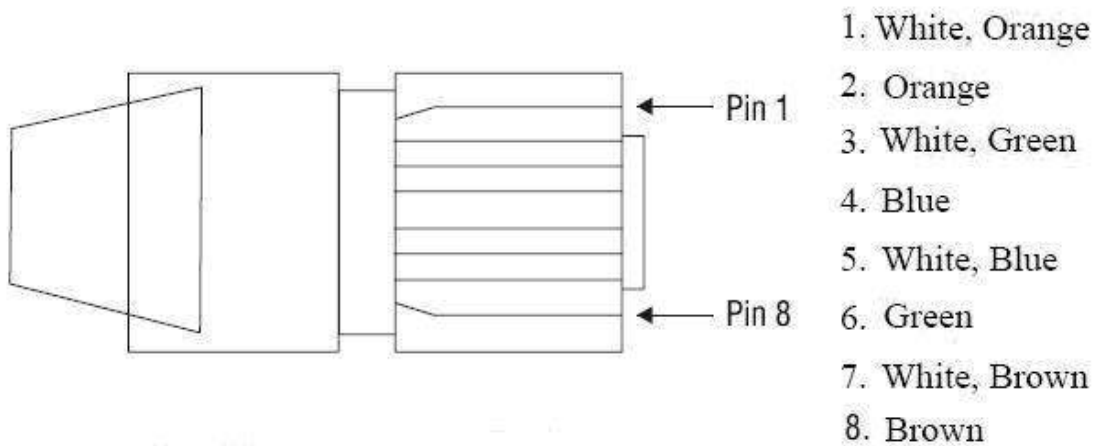

Figure A.2: EIA/TIA-568B

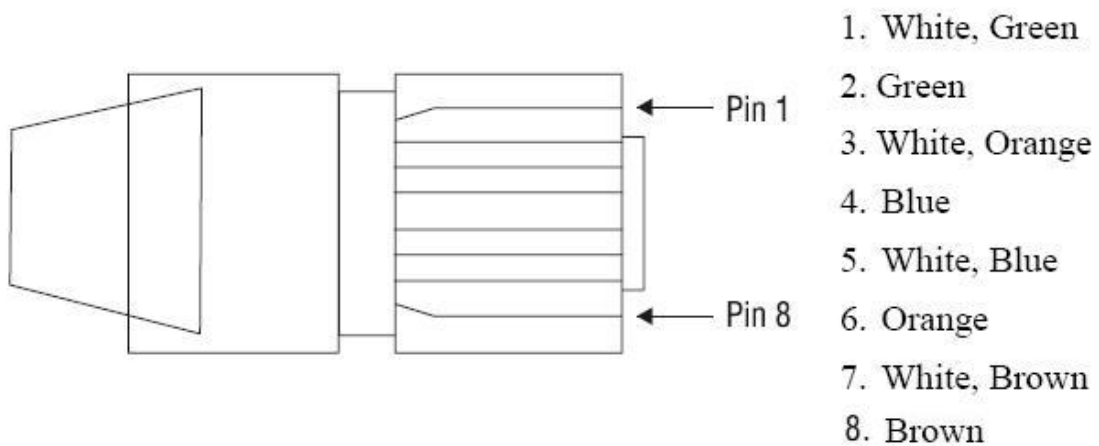
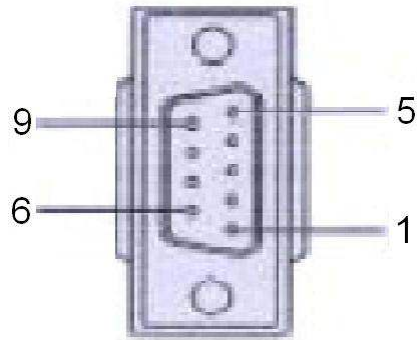

Figure A.3: EIA/TIA-568A



DB 9-pin Female

Figure A.4: DB 9-pin female connector

DB9 Connector	RJ-45 Connector
NC	1 Orange/White
2	2 Orange
3	3 Green/White
NC	4 Blue
5	5 Blue/White
NC	6 Green
NC	7 Brown/White
NC	8 Brown



APPENDIX  
**B**

**Compatible SFP  
Transceivers**

## Appendix B Compatible SFP Transceivers

The table below shows compatible SFP transceivers for EKI-7758F.

Item	Brand	Part Number	Mode	Transmission Distance
1	AVAGO	AFBR-5710PZ	Multi-mode	550m
2	APAC	LM28-C3S-TC-N		550m
3	HOATECH	HTI8512-X5ATO		550m
4	SPACE SHUTTLE	S56L-S85-6L-N		550m
5	LuminentOIC	SP-GB-LX	Single-mode	10km
		SP-GB-ELX		20km
		SP-GB-XD		50km
6	AVAGO	AFCT-5710PZ		10km
7	APAC	LS38-C3M-TC-N		20km
8	SPACE SHUTTLE	S56L-L13-6L-N		10km