

FLATLINK™ TRANSMITTERS

FEATURES

- 21:3 Data Channel Compression at up to 163 Million Bytes per Second Throughput
- Suited for SVGA, XGA, or SXGA Data Transmission From Controller to Display With Very Low EMI
- 21 Data Channels Plus Clock-In Low-Voltage TTL and 3 Data Channels Plus Clock-Out Low-Voltage Differential
- Operates From a Single 3.3-V Supply and 250 mW (Typ)
- 5-V Tolerant Data Inputs
- ESD Protection Exceeds 6 kV
- SN75LVDS84 Has Falling-Clock Edge-Triggered Inputs
- Packaged in Thin Shrink Small-Outline Package (TSSOP) With 20-Mil Terminal Pitch
- Consumes Less Than 1 mW When Disabled
- Wide Phase-Lock Input Frequency Range:
 - 31 MHz to 68 MHz
- No External Components Required for PLL
- Outputs Meet or Exceed the Requirements of ANSI EIA/TIA-644 Standard
- Improved Replacement for the DS90C561

DGG PACKAGE
(TOP VIEW)

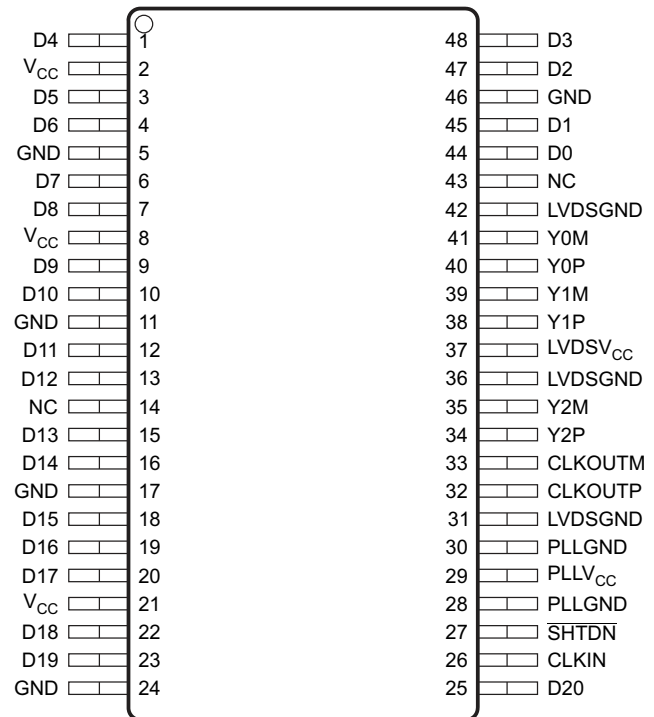

NC - Not Connected

P0052-02

DESCRIPTION

The SN75LVDS84 FlatLink™ transmitter contains three 7-bit parallel-load serial-out shift registers, a 7× clock synthesizer, and four low-voltage differential signaling (LVDS) line drivers in a single integrated circuit. These functions allow 21 bits of single-ended low-voltage TTL (LVTTTL) data to be synchronously transmitted over three balanced-pair conductors for receipt by a compatible receiver, such as the SN75LVDS82 or SN75LVDS86.

When transmitting, data bits D0–D20 are each loaded into registers of the SN75LVDS84 on the falling edge of the input clock signal (CLKIN). The frequency of CLKIN is multiplied seven times and then used to unload the data registers in 7-bit slices and serially. The three serial streams and a phase-locked clock (CLKOUT) are then output to LVDS output drivers. The frequency of CLKOUT is the same as the input clock, CLKIN.

AVAILABLE OPTIONS⁽¹⁾

LATCHING CLOCK EDGE
FALLING
SN75LVDS84DGG
SN75LVDS84DGGR

(1) The R suffix indicates taped and reeled packaging.



Please be aware that an important notice concerning availability, standard warranty, and use in critical applications of Texas Instruments semiconductor products and disclaimers thereto appears at the end of this data sheet.

FlatLink is a trademark of Texas Instruments.

All other trademarks are the property of their respective owners.

DESCRIPTION (CONTINUED)

The SN75LVDS84 requires no external components and little or no control. The data bus appears the same at the input to the transmitter and output of the receiver with the data transmission transparent to the user(s). The only possible user intervention is the use of the shutdown/clear ($\overline{\text{SHTDN}}$) active-low input to inhibit the clock and shut off the LVDS output drivers for lower power consumption. A low level on this signal clears all internal registers to a low level.

The SN75LVDS84 is characterized for operation over ambient free-air temperatures of 0°C to 70°C.

FUNCTIONAL BLOCK DIAGRAM

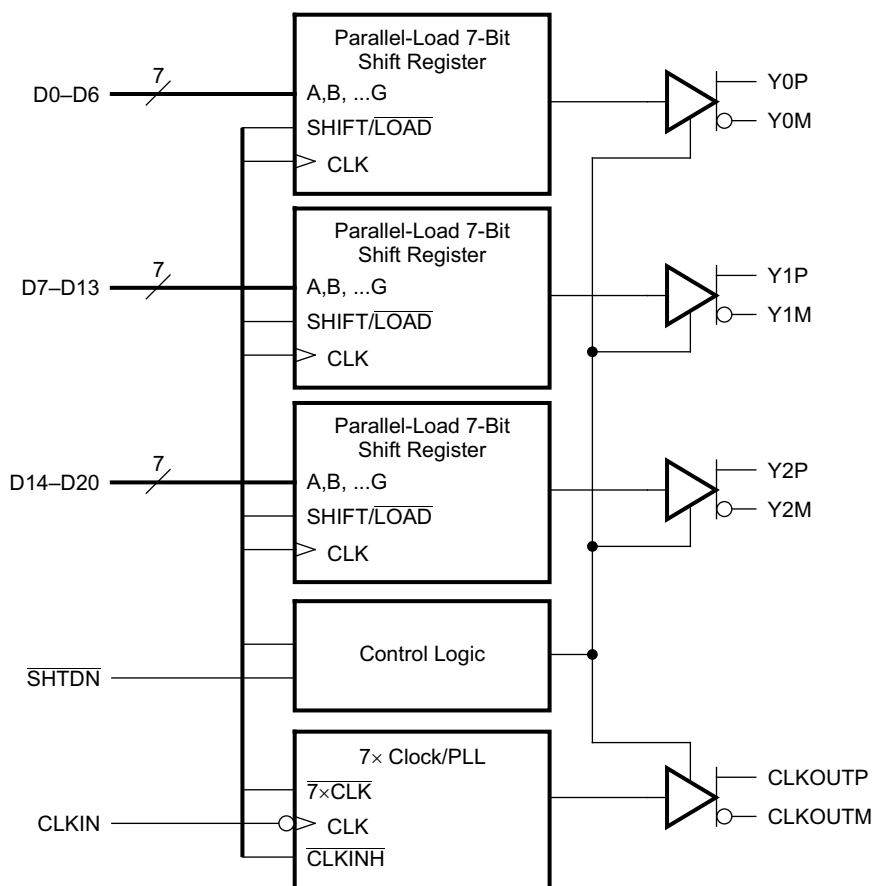

B0274-01

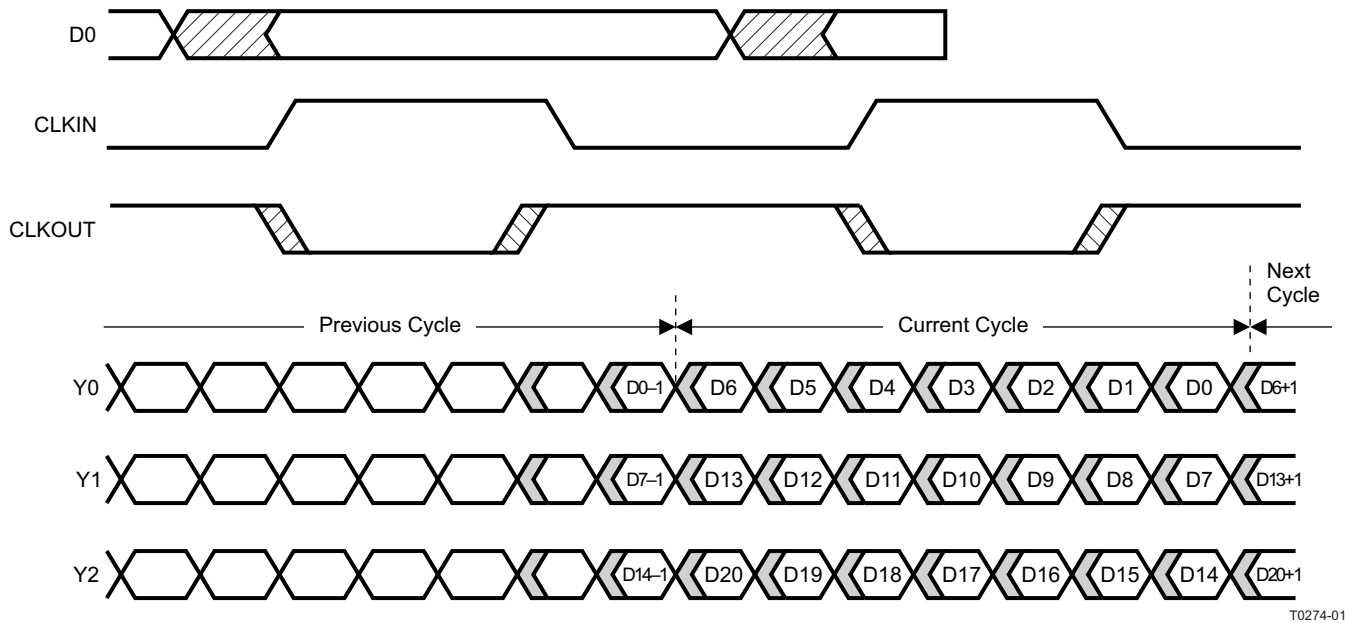

T0274-01

Figure 1. Load and Shift Timing Sequences

SCHEMATICS OF INPUT AND OUTPUT

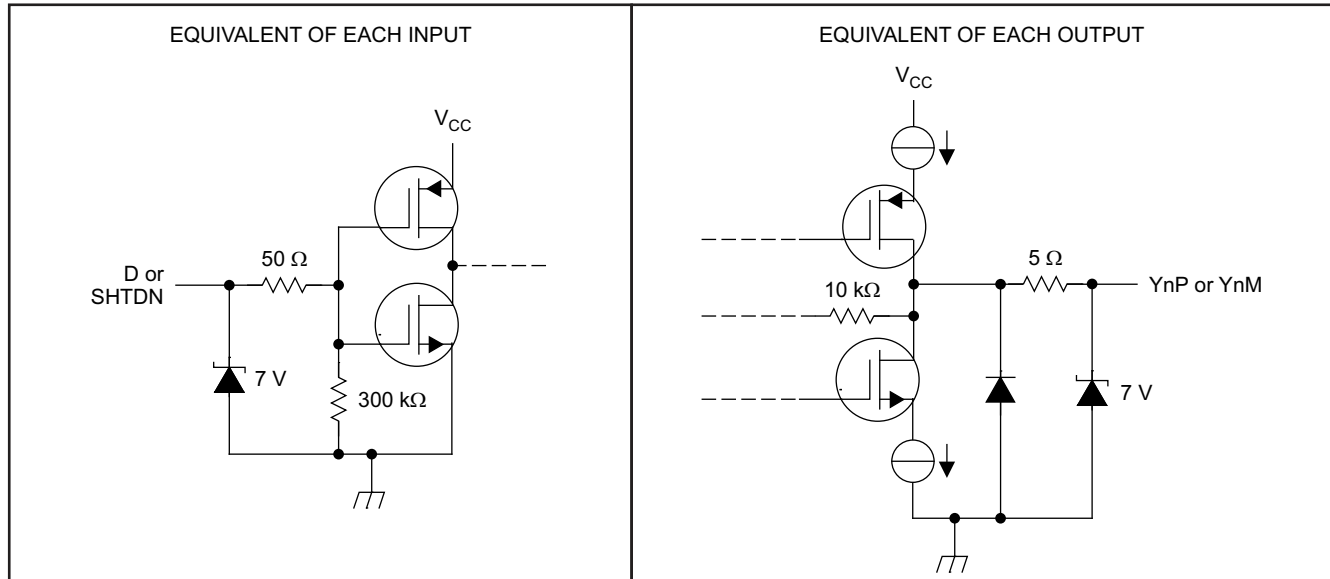

S0313-01

ABSOLUTE MAXIMUM RATINGSover operating free-air temperature range (unless otherwise noted) ⁽¹⁾

		VALUE	UNIT
V _{CC}	Supply voltage range ⁽²⁾	–0.5 to 4	V
V _O	Output voltage range (all terminals)	–0.5 to V _{CC} + 0.5	V
V _I	Input voltage range (all terminals)	–0.5 to 5.5	
	Continuous total power dissipation	See Dissipation Rating Table	
T _{stg}	Storage temperature range	–6 to 150	°C
	Lead temperature 1,6 mm (1/16 inch) from case for 10 seconds	260	°C

(1) Stresses beyond those listed under *absolute maximum ratings* may cause permanent damage to the device. These are stress ratings only, and functional operation of the device at these or any other conditions beyond those indicated under *recommended operating conditions* is not implied. Exposure to absolute-maximum-rated conditions for extended periods may affect device reliability.

(2) All voltage values are with respect to the GND terminals.

DISSIPATION RATINGS

PACKAGE	T _A ≤ 25°C POWER RATING	DERATING FACTOR ⁽¹⁾ ABOVE T _A = 25°C	T _A = 70°C POWER RATING
DGG	1316 mW	13.1 mW/°C	726 mW

(1) This is the inverse of the junction-to-ambient thermal resistance when board mounted and with no air flow.

RECOMMENDED OPERATING CONDITIONS

		MIN	NOM	MAX	UNIT
V _{CC}	Supply voltage	3	3.3	3.6	V
V _{IH}	High-level input voltage	2			V
V _{IL}	Low-level input voltage			0.8	V
Z _L	Differential load impedance	90		132	Ω
T _A	Operating free-air temperature	0		70	°C

TIMING REQUIREMENTS

	PARAMETER	MIN	TYP	MAX	UNIT
t _c	Input clock period	14.7		32.4	ns
t _w	Pulse duration, high-level input clock	0.4 t _c		0.6 t _c	ns
t _t	Transition time, input signal			5	ns
t _{su}	Setup time, data, D0–D27 valid before CLKIN↓ (See Figure 2)	3			ns
t _h	Hold time, data, D0–D27 valid after CLKIN↓ (See Figure 2)	1.5			ns

ELECTRICAL CHARACTERISTICS

over recommended operating conditions (unless otherwise noted)

PARAMETER		TEST CONDITIONS	MIN	TYP ⁽¹⁾	MAX	UNIT
V_{IT}	Input threshold voltage			1.4		V
$ V_{OD} $	Differential steady-state output voltage magnitude		247		454	mV
$\Delta V_{OD} $	Change in the steady-state differential output voltage magnitude between opposite binary states	$R_L = 100 \Omega$, See Figure 3			50	mV
$V_{OC(SS)}$	Steady-state common-mode output voltage		1.125		1.375	V
$V_{OC(PP)}$	Peak-to-peak common-mode output voltage	See Figure 3		80	150	mV
I_{IH}	High-level input current	$V_{IH} = V_{CC}$			20	μA
I_{IL}	Low-level input current	$V_{IL} = 0$			± 10	μA
I_{OS}	Short-circuit output current	$V_{O(Yn)} = 0$			± 24	mA
		$V_{OD} = 0$			± 12	mA
I_{OZ}	High-impedance output current	$V_O = 0$ to V_{CC}			± 10	μA
$I_{CC(AVG)}$	Quiescent supply current (average)	Disabled, all inputs at GND			280	μA
		Enabled, $R_L = 100 \Omega$ (4 places), gray-scale pattern (see Figure 4), $V_{CC} = 3.3 V$, $t_c = 15.38 ns$		68	80	mA
		Enabled, $R_L = 100 \Omega$, (4 places), worst-case pattern (see Figure 5), $t_c = 15.38 ns$		75	100	mA
C_I	Input capacitance			3		pF

 (1) All typical values are at $V_{CC} = 3.3 V$, $T_A = 25^\circ C$.

SWITCHING CHARACTERISTICS

over operating free-air temperature range (unless otherwise noted)

PARAMETER		TEST CONDITIONS	MIN	TYP ⁽¹⁾	MAX	UNIT
t_{d0}	Delay time, CLKOUT \uparrow to serial bit position 0	$t_c = 15.38 \text{ ns } (\pm 0.2\%)$, Input clock jitter < 50 ps ⁽²⁾ , See Figure 6	-0.2	0	0.2	ns
t_{d1}	Delay time, CLKOUT \uparrow to serial bit position 1		$\frac{1}{7}t_c - 0.2$		$\frac{1}{7}t_c + 0.2$	ns
t_{d2}	Delay time, CLKOUT \uparrow to serial bit position 2		$\frac{2}{7}t_c - 0.2$		$\frac{2}{7}t_c + 0.2$	ns
t_{d3}	Delay time, CLKOUT \uparrow to serial bit position 3		$\frac{3}{7}t_c - 0.2$		$\frac{3}{7}t_c + 0.2$	ns
t_{d4}	Delay time, CLKOUT \uparrow to serial bit position 4		$\frac{4}{7}t_c - 0.2$		$\frac{4}{7}t_c + 0.2$	ns
t_{d5}	Delay time, CLKOUT \uparrow to serial bit position 5		$\frac{5}{7}t_c - 0.2$		$\frac{5}{7}t_c + 0.2$	ns
t_{d6}	Delay time, CLKOUT \uparrow to serial bit position 6		$\frac{6}{7}t_c - 0.2$		$\frac{6}{7}t_c + 0.2$	ns
$t_{sk(o)}$	Output skew, $t_n - \frac{n}{7}t_c$		-0.2		0.2	ns
t_{d7}	Delay time, CLKIN \downarrow to CLKOUT \uparrow	$t_c = 15.38 \text{ ns } (\pm 0.2\%)$, Input clock jitter < 50 ps ⁽²⁾ , see Figure 6		4.2		ns
$\Delta t_{c(o)}$	Cycle time, output clock jitter ⁽³⁾	$t_c = 15.38 + 0.75 \sin(2\pi 500E3t) \pm 0.05 \text{ ns}$, See Figure 7		± 70		ps
		$t_c = 15.38 + 0.75 \sin(2\pi 3E3t) \pm 0.05 \text{ ns}$, See Figure 7		± 187		ps
t_w	Pulse duration, high-level output clock			$\frac{4}{7}t_c$		ns
t_t	Transition time, differential output voltage (t_r or t_f)	See Figure 3	260	700	1500	ps
t_{en}	Enable time, $\overline{\text{SHTDN}}\uparrow$ to phase lock (Yn valid)	See Figure 8		1		ms
t_{dis}	Disable time, $\overline{\text{SHTDN}}\downarrow$ to off state (CLKOUT low)	See Figure 9		250		ns

(1) All typical values are at $V_{CC} = 3.3 \text{ V}$, $T_A = 25^\circ\text{C}$.

(2) |Input clock jitter| is the magnitude of the change in the input clock period.

(3) Output clock jitter is the change in the output clock period from one cycle to the next cycle observed over 15,000 cycles.

PARAMETER MEASUREMENT INFORMATION

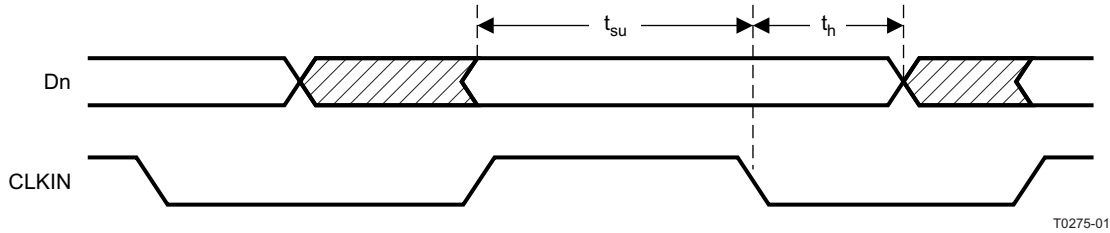

A. All input timing is defined at 1.4 V on an input signal with a 10%-to-90% rise or fall time of less than 5 ns.

Figure 2. Setup and Hold Time Definition

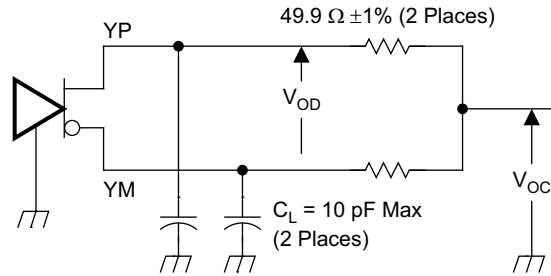

Note: The lumped instrumentation capacitance for any single-ended voltage measurement is less than or equal to 10 pF. When making measurements at YP or YM, the complementary output is similarly loaded.

(a) Schematic

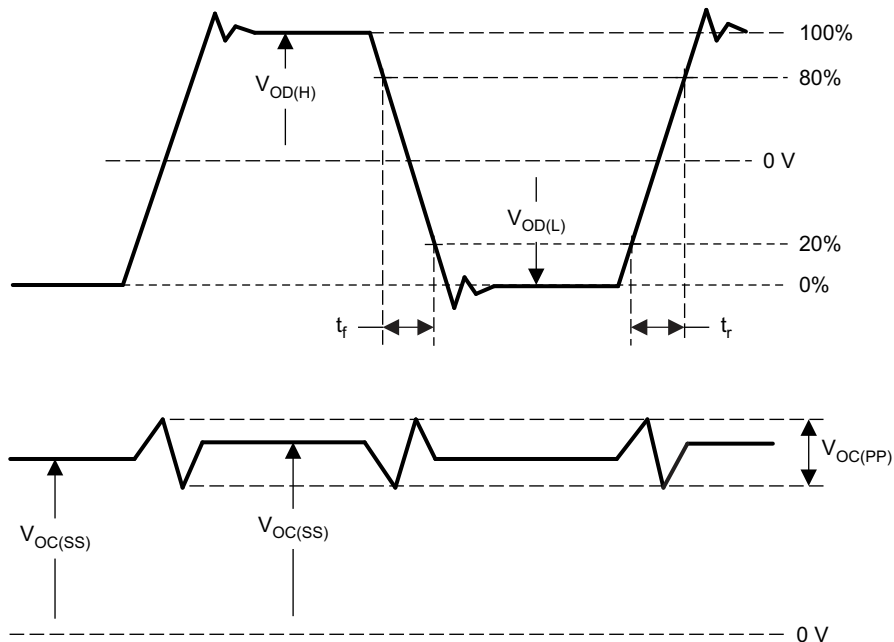

(b) Waveforms

S0314-01

Figure 3. Test Load and Voltage Definitions for LVDS Outputs

PARAMETER MEASUREMENT INFORMATION (continued)

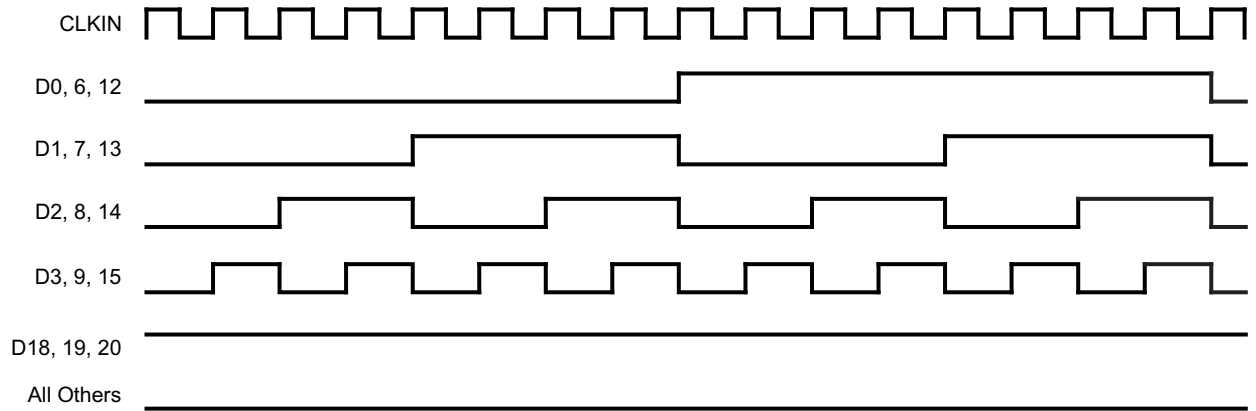

T0276-01

- A. The 16-grayscale test-pattern test device power consumption for a typical display pattern.
- B. $V_{IH} = 2\text{ V}$ and $V_{IL} = 0.8\text{ V}$

Figure 4. 16-Grayscale Test-Pattern Waveforms

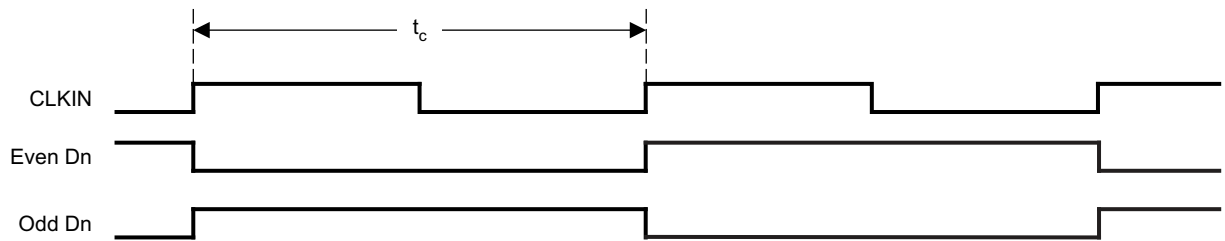

T0277-01

- A. The worst-case test pattern produces nearly the maximum switching frequency for all of the LVDS outputs.
- B. $V_{IH} = 2\text{ V}$ and $V_{IL} = 0.8\text{ V}$

Figure 5. Worst-Case Test-Pattern Waveforms

PARAMETER MEASUREMENT INFORMATION (continued)

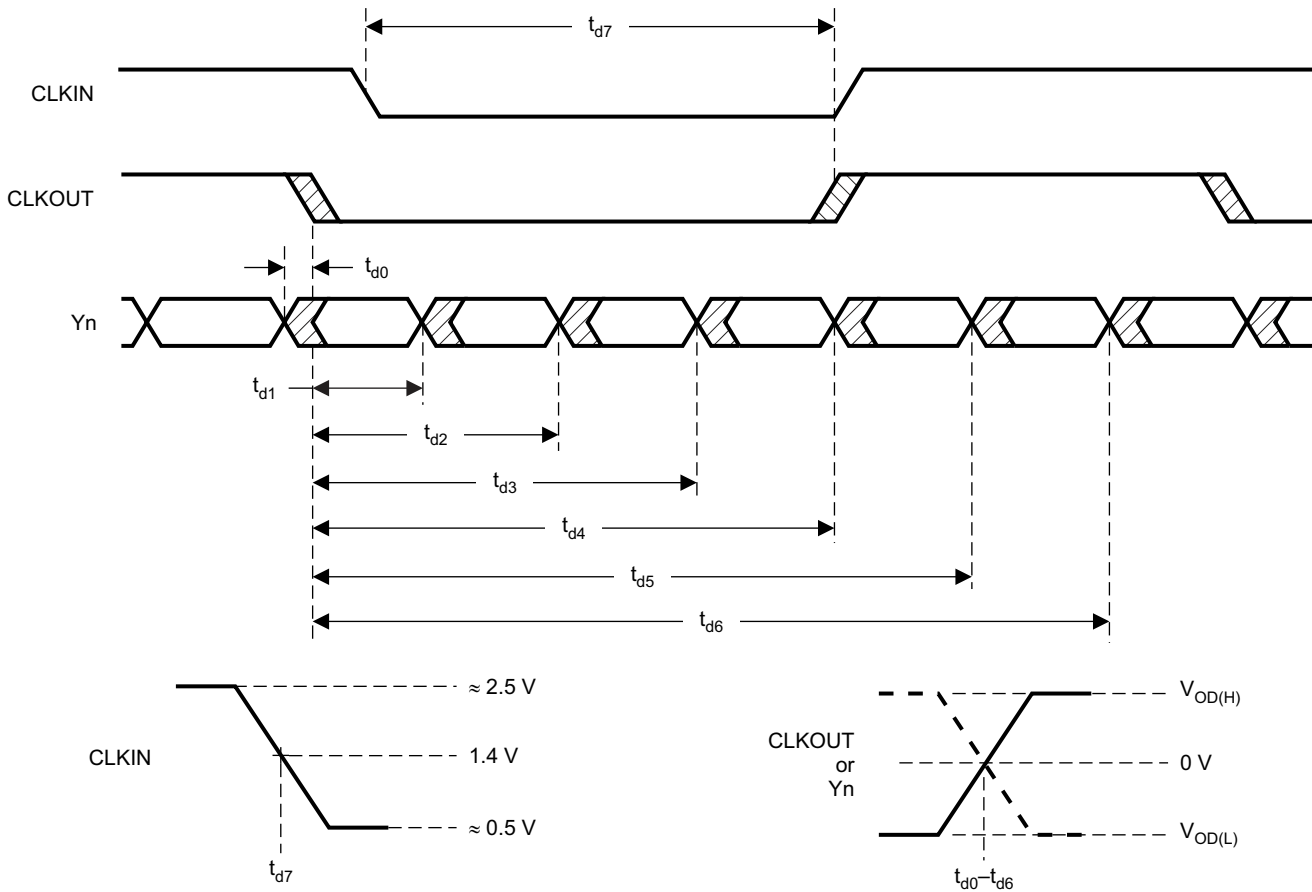

T0278-01

Figure 6. Timing Definitions

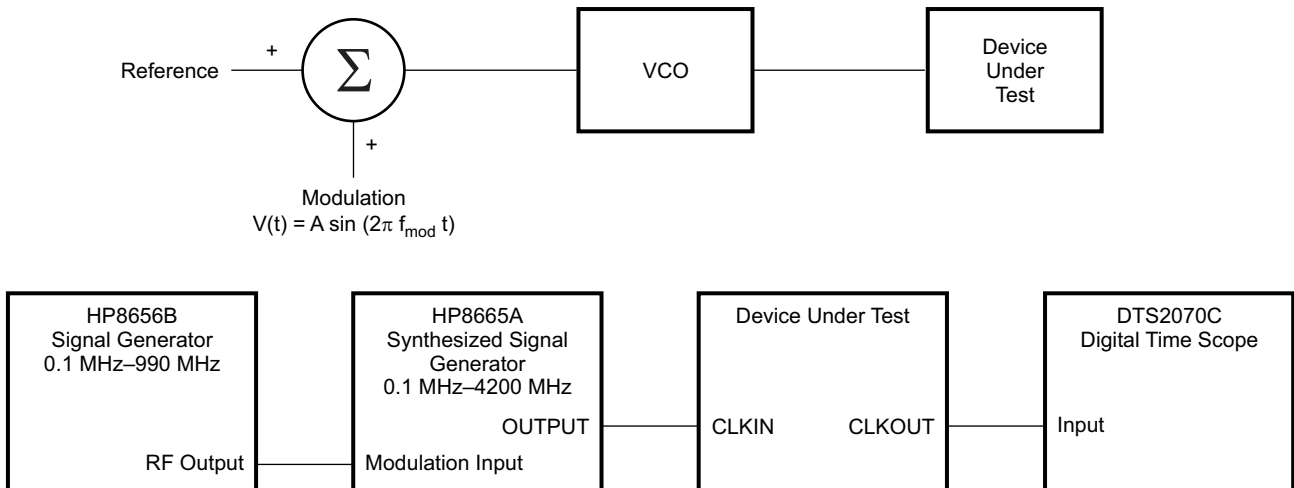

B0275-01

Figure 7. Clock Jitter Test Setup

TYPICAL CHARACTERISTICS

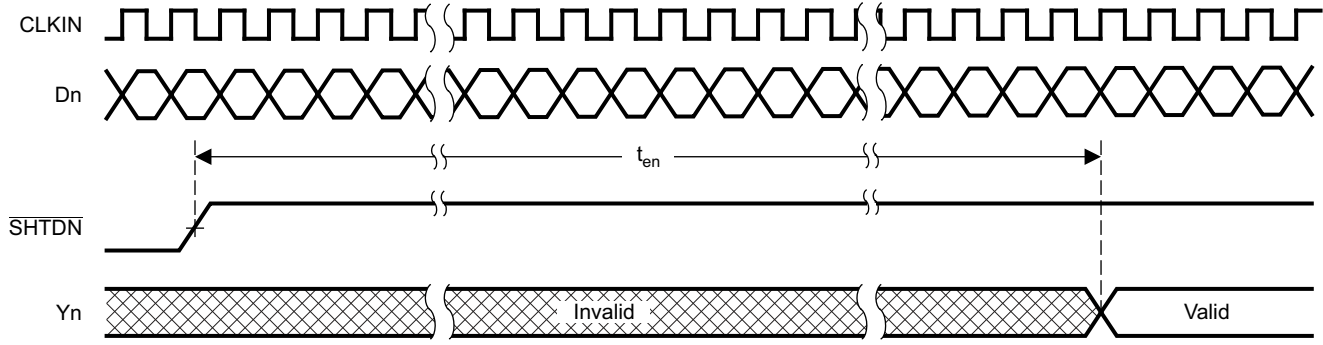

T0279-01

Figure 8. Enable Time Waveforms

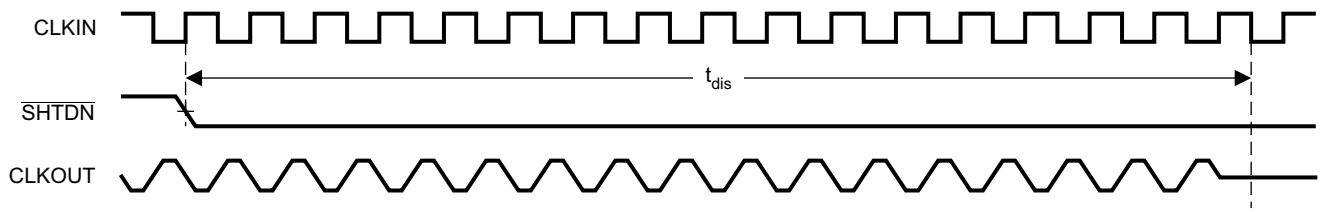

T0280-01

Figure 9. Disable Time Waveforms

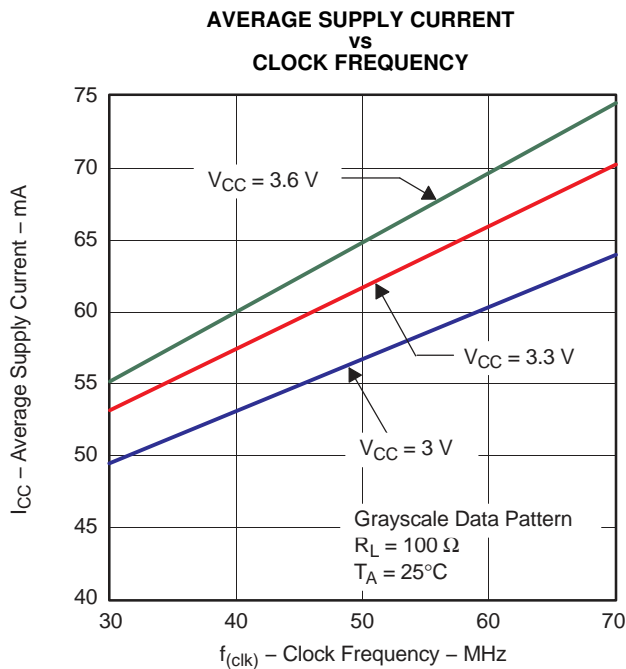

G001

Figure 10.

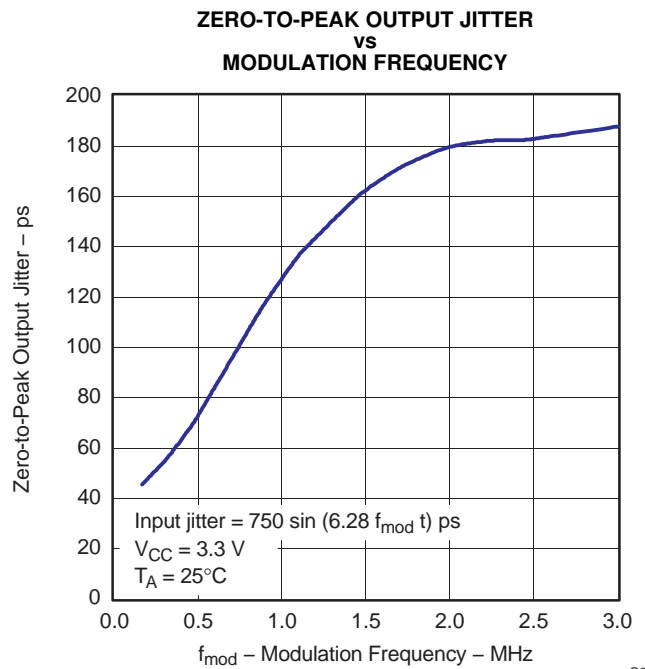

G002

Figure 11.

APPLICATION INFORMATION

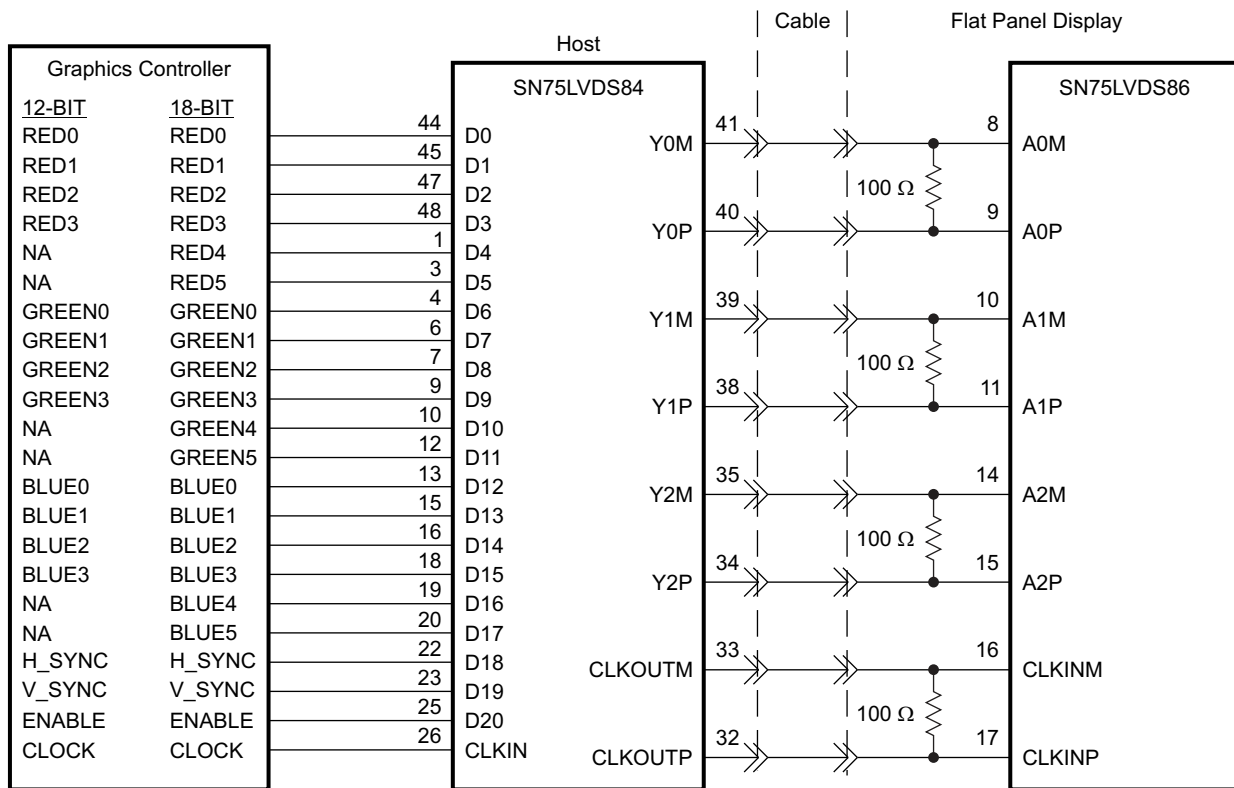

B0276-01

- A. The five 100-Ω terminating resistors are recommended to be 0603 types.
- B. NA – not applicable, these unused inputs should be left open.

Figure 12. Color Host to LCD Panel Application

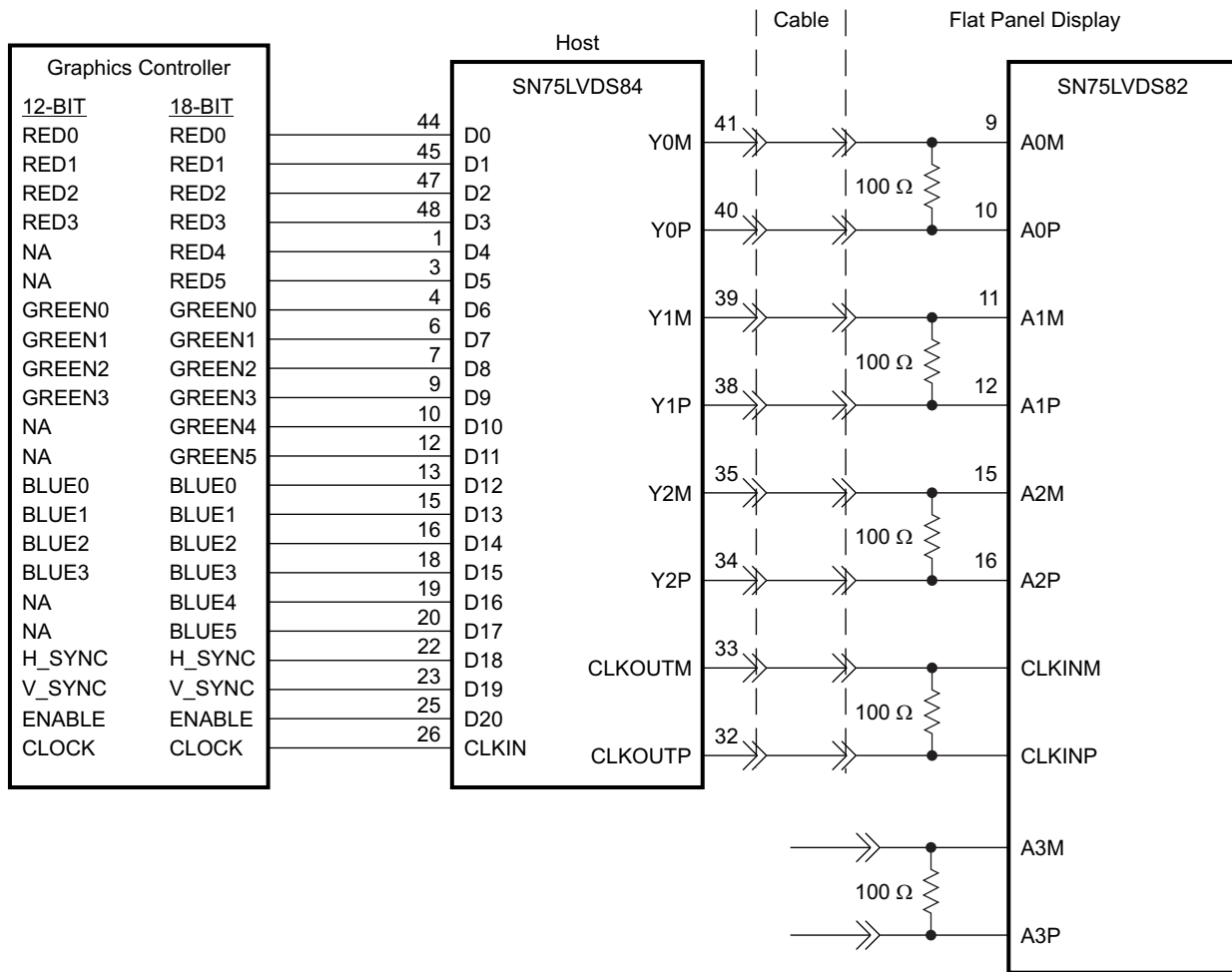

B0277-01

- A. The four 100-Ω terminating resistors are recommended to be 0603 types.
- B. NA – not applicable, these unused inputs should be left open.

Figure 13. 18-Bit Color Host to 24-Bit LCD Display Panel Application
(See the FlatLink Designer's Guide (SLLA012) for more application information.)

PACKAGING INFORMATION

Orderable Device	Status (1)	Package Type	Package Drawing	Pins	Package Qty	Eco Plan (2)	Lead finish/ Ball material (6)	MSL Peak Temp (3)	Op Temp (°C)	Device Marking (4/5)	Samples
SN75LVDS84DGG	ACTIVE	TSSOP	DGG	48	40	RoHS & Green	NIPDAU	Level-2-260C-1 YEAR	0 to 70	SN75LVDS84	Samples
SN75LVDS84DGGG4	ACTIVE	TSSOP	DGG	48	40	RoHS & Green	NIPDAU	Level-2-260C-1 YEAR	0 to 70	SN75LVDS84	Samples
SN75LVDS84DGGR	ACTIVE	TSSOP	DGG	48	2000	RoHS & Green	NIPDAU	Level-2-260C-1 YEAR	0 to 70	SN75LVDS84	Samples

(1) The marketing status values are defined as follows:

ACTIVE: Product device recommended for new designs.

LIFEBUY: TI has announced that the device will be discontinued, and a lifetime-buy period is in effect.

NRND: Not recommended for new designs. Device is in production to support existing customers, but TI does not recommend using this part in a new design.

PREVIEW: Device has been announced but is not in production. Samples may or may not be available.

OBSOLETE: TI has discontinued the production of the device.

(2) **RoHS:** TI defines "RoHS" to mean semiconductor products that are compliant with the current EU RoHS requirements for all 10 RoHS substances, including the requirement that RoHS substance do not exceed 0.1% by weight in homogeneous materials. Where designed to be soldered at high temperatures, "RoHS" products are suitable for use in specified lead-free processes. TI may reference these types of products as "Pb-Free".

RoHS Exempt: TI defines "RoHS Exempt" to mean products that contain lead but are compliant with EU RoHS pursuant to a specific EU RoHS exemption.

Green: TI defines "Green" to mean the content of Chlorine (Cl) and Bromine (Br) based flame retardants meet JS709B low halogen requirements of <=1000ppm threshold. Antimony trioxide based flame retardants must also meet the <=1000ppm threshold requirement.

(3) MSL, Peak Temp. - The Moisture Sensitivity Level rating according to the JEDEC industry standard classifications, and peak solder temperature.

(4) There may be additional marking, which relates to the logo, the lot trace code information, or the environmental category on the device.

(5) Multiple Device Markings will be inside parentheses. Only one Device Marking contained in parentheses and separated by a "~" will appear on a device. If a line is indented then it is a continuation of the previous line and the two combined represent the entire Device Marking for that device.

(6) Lead finish/Ball material - Orderable Devices may have multiple material finish options. Finish options are separated by a vertical ruled line. Lead finish/Ball material values may wrap to two lines if the finish value exceeds the maximum column width.

Important Information and Disclaimer:The information provided on this page represents TI's knowledge and belief as of the date that it is provided. TI bases its knowledge and belief on information provided by third parties, and makes no representation or warranty as to the accuracy of such information. Efforts are underway to better integrate information from third parties. TI has taken and continues to take reasonable steps to provide representative and accurate information but may not have conducted destructive testing or chemical analysis on incoming materials and chemicals. TI and TI suppliers consider certain information to be proprietary, and thus CAS numbers and other limited information may not be available for release.

In no event shall TI's liability arising out of such information exceed the total purchase price of the TI part(s) at issue in this document sold by TI to Customer on an annual basis.

TAPE AND REEL INFORMATION

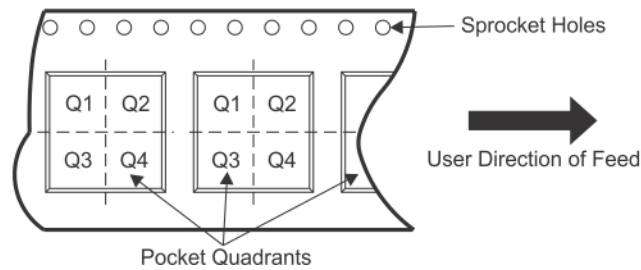
QUADRANT ASSIGNMENTS FOR PIN 1 ORIENTATION IN TAPE

*All dimensions are nominal

Device	Package Type	Package Drawing	Pins	SPQ	Reel Diameter (mm)	Reel Width W1 (mm)	A0 (mm)	B0 (mm)	K0 (mm)	P1 (mm)	W (mm)	Pin1 Quadrant
SN75LVDS84DGGR	TSSOP	DGG	48	2000	330.0	24.4	8.6	13.0	1.8	12.0	24.0	Q1

TAPE AND REEL BOX DIMENSIONS

*All dimensions are nominal

Device	Package Type	Package Drawing	Pins	SPQ	Length (mm)	Width (mm)	Height (mm)
SN75LVDS84DGGR	TSSOP	DGG	48	2000	350.0	350.0	43.0

TUBE

*All dimensions are nominal

Device	Package Name	Package Type	Pins	SPQ	L (mm)	W (mm)	T (μm)	B (mm)
SN75LVDS84DGG	DGG	TSSOP	48	40	530	11.89	3600	4.9
SN75LVDS84DGGG4	DGG	TSSOP	48	40	530	11.89	3600	4.9

EXAMPLE BOARD LAYOUT

DGG0048A

TSSOP - 1.2 mm max height

SMALL OUTLINE PACKAGE

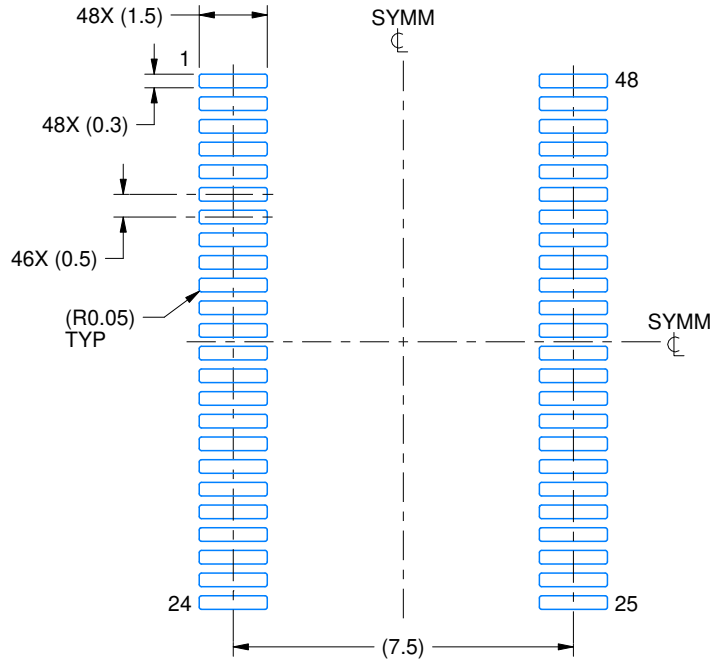

LAND PATTERN EXAMPLE
SCALE:6X

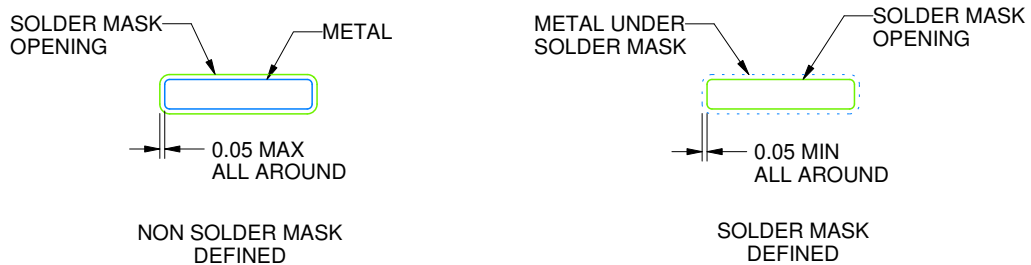

SOLDER MASK DETAILS

4214859/B 11/2020

NOTES: (continued)

- 5. Publication IPC-7351 may have alternate designs.
- 6. Solder mask tolerances between and around signal pads can vary based on board fabrication site.

EXAMPLE STENCIL DESIGN

DGG0048A

TSSOP - 1.2 mm max height

SMALL OUTLINE PACKAGE

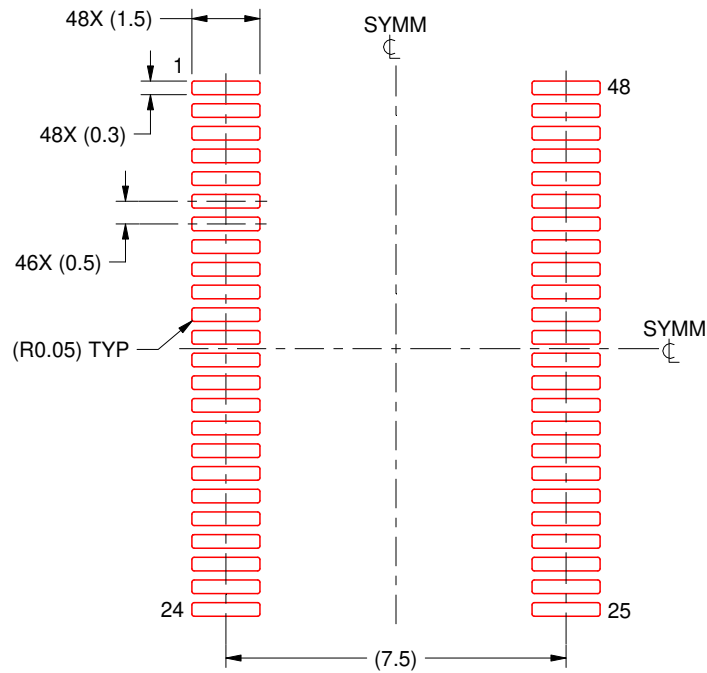

SOLDER PASTE EXAMPLE
BASED ON 0.125 mm THICK STENCIL
SCALE:6X

4214859/B 11/2020

NOTES: (continued)

7. Laser cutting apertures with trapezoidal walls and rounded corners may offer better paste release. IPC-7525 may have alternate design recommendations.
8. Board assembly site may have different recommendations for stencil design.

DGG (R-PDSO-G**)

PLASTIC SMALL-OUTLINE PACKAGE

48 PINS SHOWN

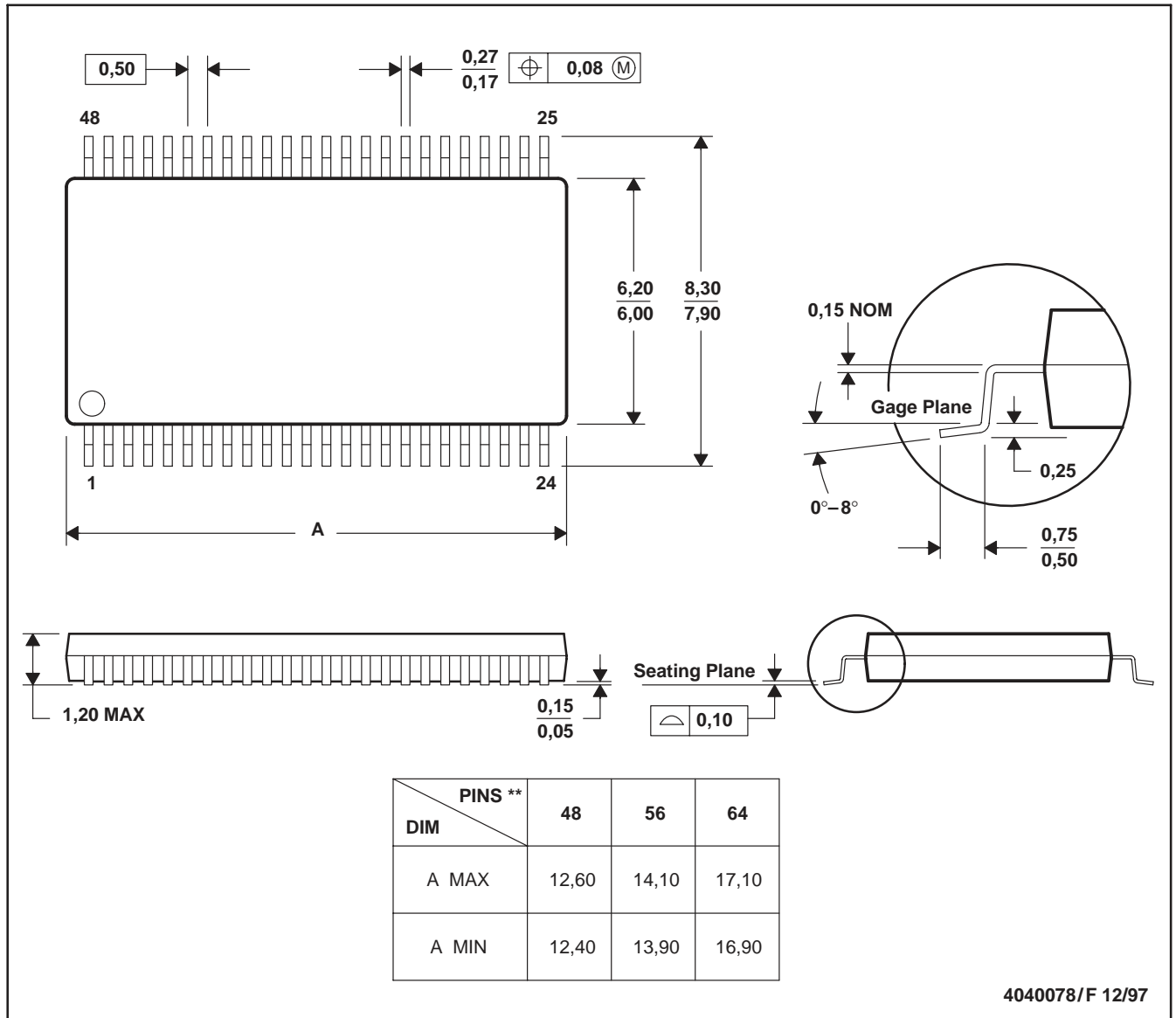

- NOTES: A. All linear dimensions are in millimeters.
 B. This drawing is subject to change without notice.
 C. Body dimensions do not include mold protrusion not to exceed 0,15.
 D. Falls within JEDEC MO-153

IMPORTANT NOTICE AND DISCLAIMER

TI PROVIDES TECHNICAL AND RELIABILITY DATA (INCLUDING DATA SHEETS), DESIGN RESOURCES (INCLUDING REFERENCE DESIGNS), APPLICATION OR OTHER DESIGN ADVICE, WEB TOOLS, SAFETY INFORMATION, AND OTHER RESOURCES "AS IS" AND WITH ALL FAULTS, AND DISCLAIMS ALL WARRANTIES, EXPRESS AND IMPLIED, INCLUDING WITHOUT LIMITATION ANY IMPLIED WARRANTIES OF MERCHANTABILITY, FITNESS FOR A PARTICULAR PURPOSE OR NON-INFRINGEMENT OF THIRD PARTY INTELLECTUAL PROPERTY RIGHTS.

These resources are intended for skilled developers designing with TI products. You are solely responsible for (1) selecting the appropriate TI products for your application, (2) designing, validating and testing your application, and (3) ensuring your application meets applicable standards, and any other safety, security, regulatory or other requirements.

These resources are subject to change without notice. TI grants you permission to use these resources only for development of an application that uses the TI products described in the resource. Other reproduction and display of these resources is prohibited. No license is granted to any other TI intellectual property right or to any third party intellectual property right. TI disclaims responsibility for, and you will fully indemnify TI and its representatives against, any claims, damages, costs, losses, and liabilities arising out of your use of these resources.

TI's products are provided subject to [TI's Terms of Sale](#) or other applicable terms available either on ti.com or provided in conjunction with such TI products. TI's provision of these resources does not expand or otherwise alter TI's applicable warranties or warranty disclaimers for TI products.

TI objects to and rejects any additional or different terms you may have proposed.

Mailing Address: Texas Instruments, Post Office Box 655303, Dallas, Texas 75265
Copyright © 2022, Texas Instruments Incorporated