

GaAs pHEMT MMIC 1/2 WATT POWER AMPLIFIER, 24 - 29.5 GHz

Typical Applications

The HMC863ALC4 is ideal for:

- Point-to-Point Radios
- Point-to-Multi-Point Radios
- VSAT
- Military & Space

Features

- High P1dB Output Power: +27 dBm
- High Psat Output Power: +28.5 dBm
- High Gain: 24 dB
- High Output IP3: +38.5 dBm
- Supply Voltage: +5.5 V @ 350 mA
- No External Matching Required
- 24 Lead 4x4 mm SMT Package: 16 mm²

Functional Diagram

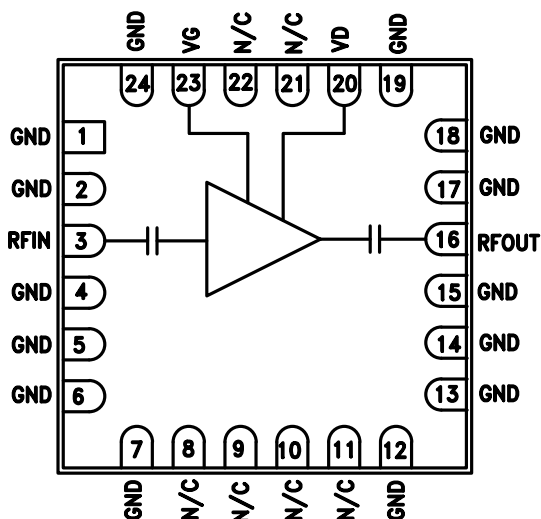

General Description

The HMC863ALC4 is a three stage GaAs pHEMT MMIC 1/2 Watt Power Amplifier which operates between 24 and 29.5 GHz. The HMC863ALC4 provides 24 dB of gain, +28.5 dBm of saturated output power and 22.5% PAE from a +5.5V supply. High output IP3 makes the HMC863ALC4 ideal for point-to-point and point-to-multi-point radio systems as well as VSAT applications. The RF I/Os are DC blocked and matched to 50 Ohms for ease of integration into higher level assemblies. The HMC863ALC4 can be operated over a Vdd range of +4.0 to +6.0V.

Electrical Specifications, $T_A = +25^\circ\text{C}$, $V_{dd} = +5.5\text{V}$, $I_{dd} = 350\text{mA}^*$

Parameter	Min.	Typ.	Max.	Min.	Typ.	Max.	Units
Frequency Range	24 - 29		29 - 29.5				GHz
Gain	20.5	24			24		dB
Gain Flatness		2			1.5		dB
Gain Variation Over Temperature		0.03			0.03		dB/°C
Input Return Loss		8			17.5		dB
Output Return Loss		13			15		dB
Output Power for 1 dB Compression (P1dB)	24.5	27			27		dBm
Saturated Output Power (Psat)		28.5			28.5		dBm
Output Third Order Intercept (IP3) *Pout/Tone = + 14 dBm		38.5			37.5		dBm
Noise Figure		4.5	6		5		dB
Supply Current (Idd)		350			350		mA
Supply Voltage (Vdd)	4	5.5	6	4	5.5	6	V

* Adjust Vgg1 between -2 to 0 V to achieve $I_{DD} = 350\text{mA}$; Typical $V_{gg1} = -0.75\text{V}$.

GaAs pHEMT MMIC 1/2 WATT POWER AMPLIFIER, 24 - 29.5 GHz

Broadband Gain and Return Loss

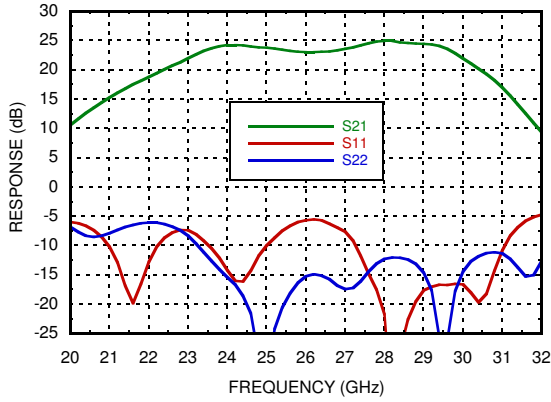

Gain vs. Temperature

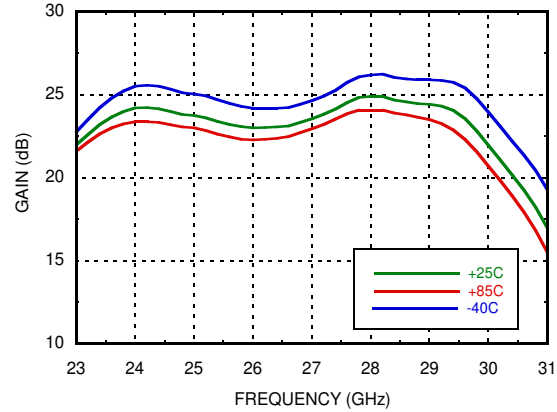

Gain vs. Vdd

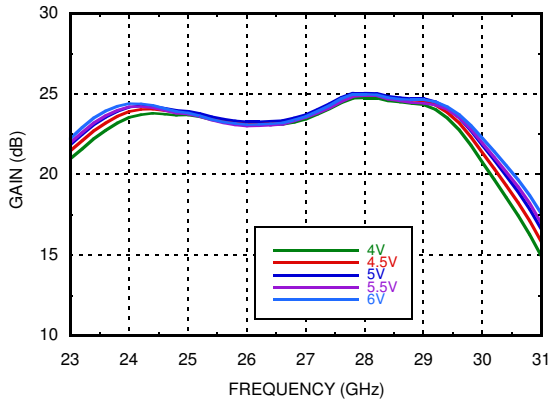

Gain vs. Idd

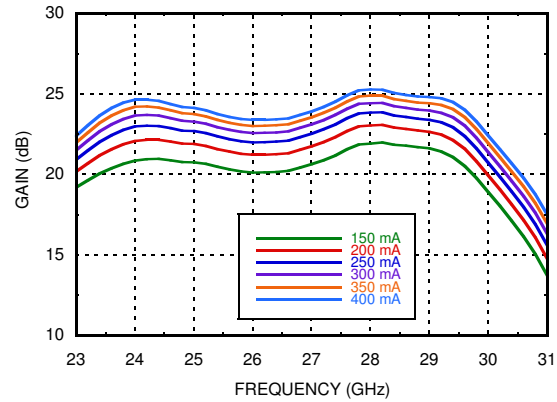

Input Return Loss vs. Temperature

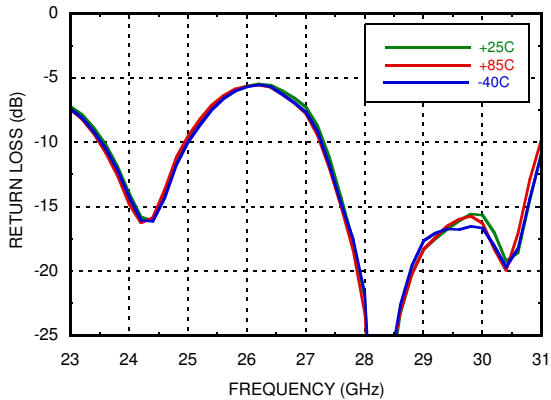

Input Return Loss vs. Vdd

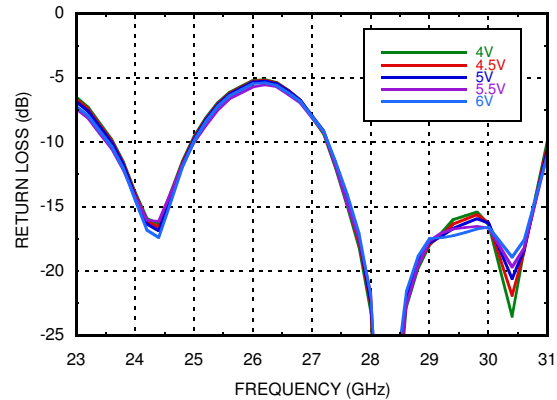

GaAs pHEMT MMIC 1/2 WATT POWER AMPLIFIER, 24 - 29.5 GHz

Input Return Loss vs. I_{dd}

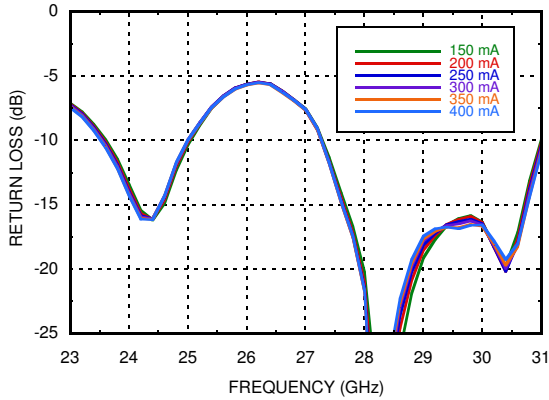

Output Return Loss vs. Temperature

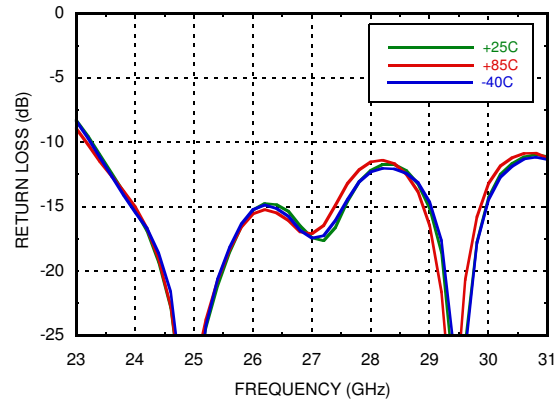

Output Return Loss vs. V_{dd}

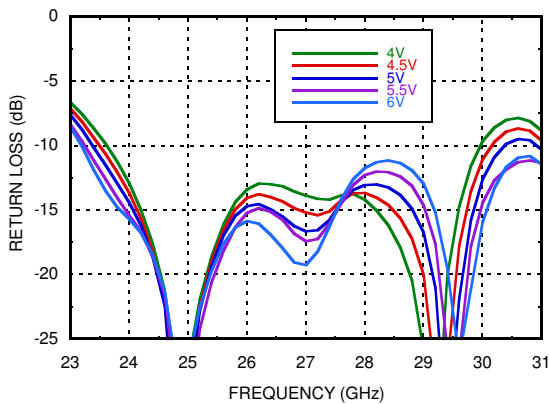

Output Return Loss vs. I_{dd}

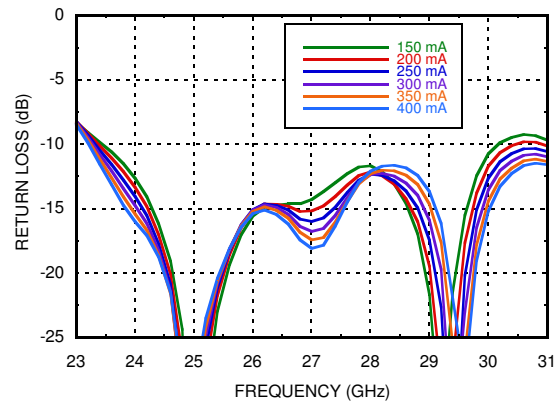

Reverse Isolation vs. Temperature

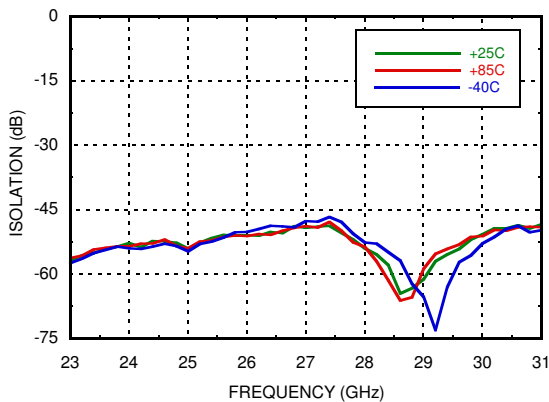

Noise Figure vs. Temperature

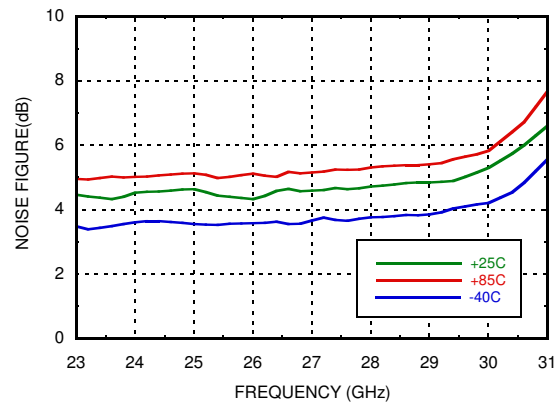

GaAs pHEMT MMIC 1/2 WATT POWER AMPLIFIER, 24 - 29.5 GHz

Noise Figure vs. Vdd

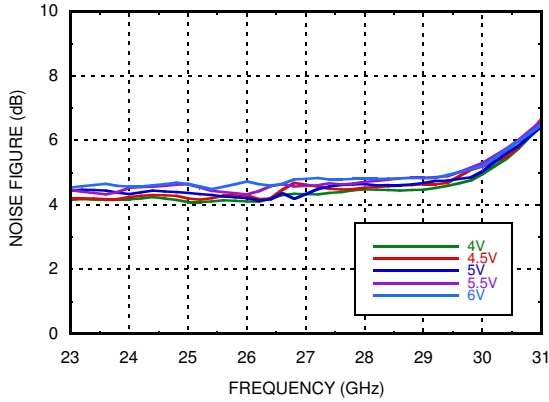

Noise Figure vs. Idd

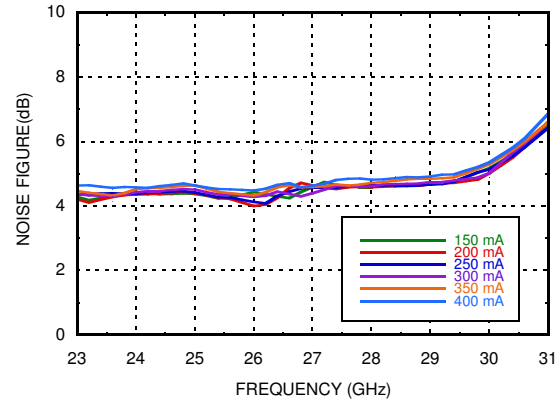

P1dB vs. Temperature

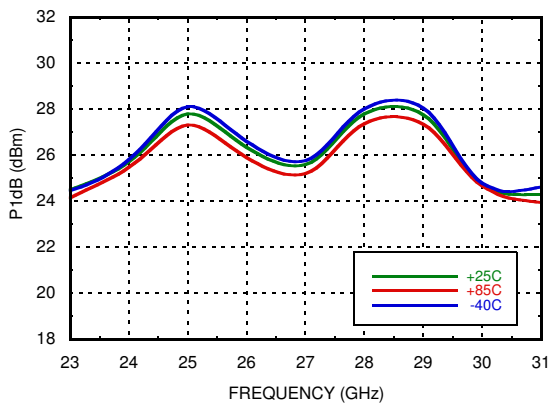

P1dB vs. Vdd

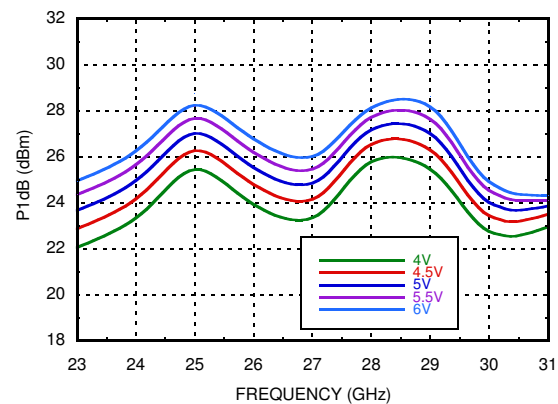

P1dB vs. Idd

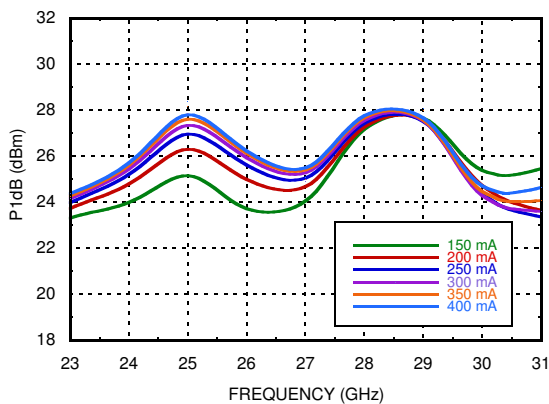

Psat vs. Temperature

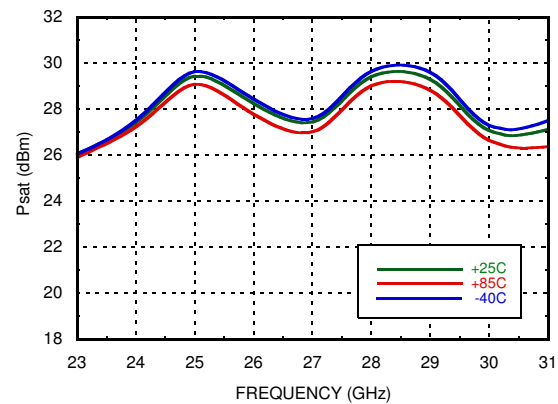

GaAs pHEMT MMIC 1/2 WATT POWER AMPLIFIER, 24 - 29.5 GHz

Psat vs. Vdd

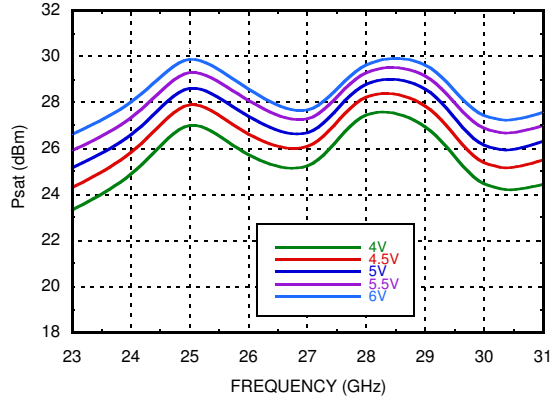

Psat vs. Idd

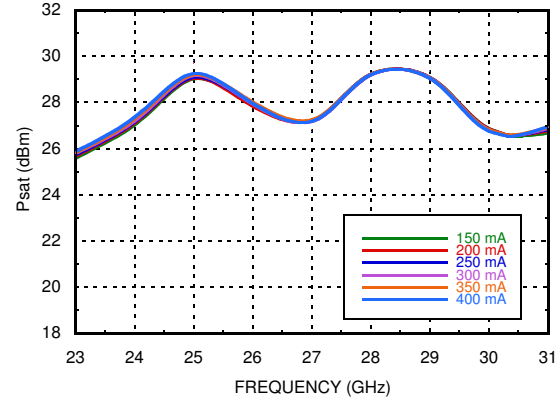

Power Compression @ 25 GHz

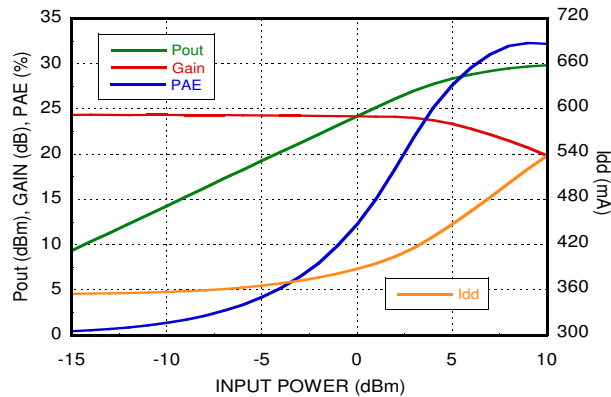

PAE @ Psat vs. Frequency

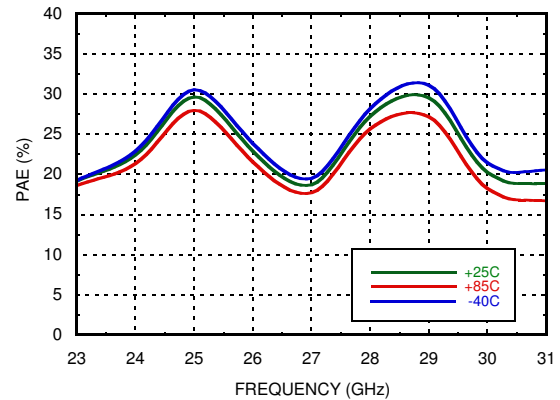

Power Dissipation @ 85° C

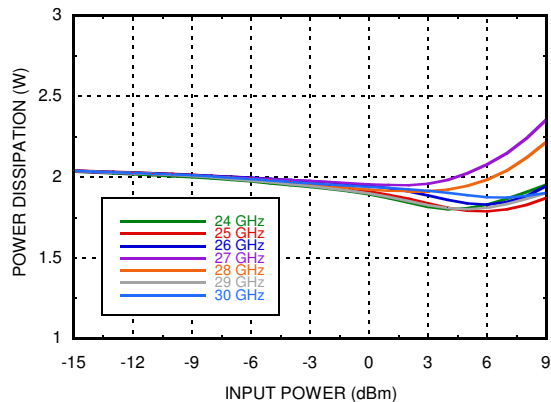

Gain and Power vs. Vdd @ 25 GHz

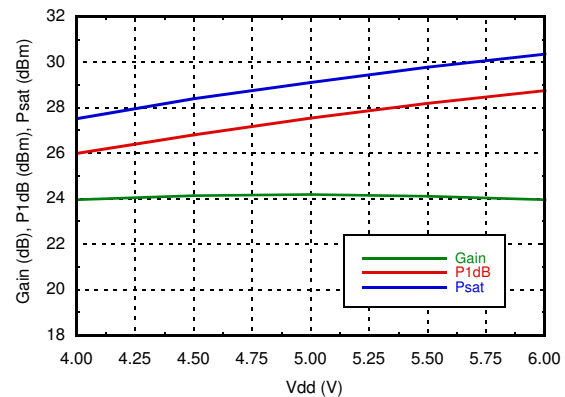

GaAs pHEMT MMIC 1/2 WATT POWER AMPLIFIER, 24 - 29.5 GHz

Gain and Power vs. Idd @ 25 GHz

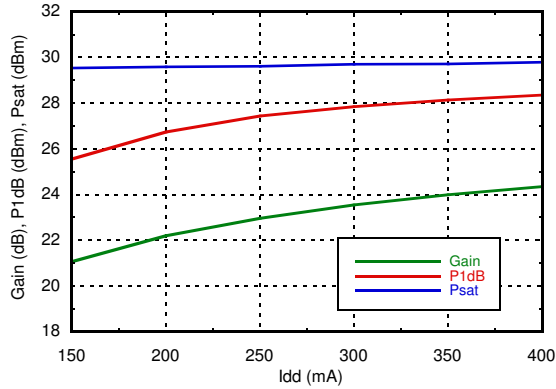

OIP3 vs. Temperature @ Pout / Tone = +14 dBm

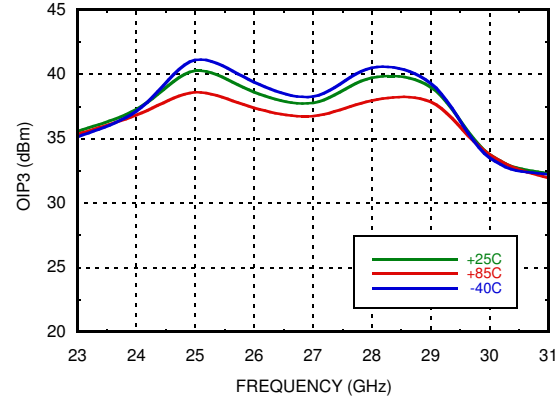

OIP3 vs. Temperature, Vdd = +6.0 V, Idd = 350 mA @ Pout / Tone = +14 dBm

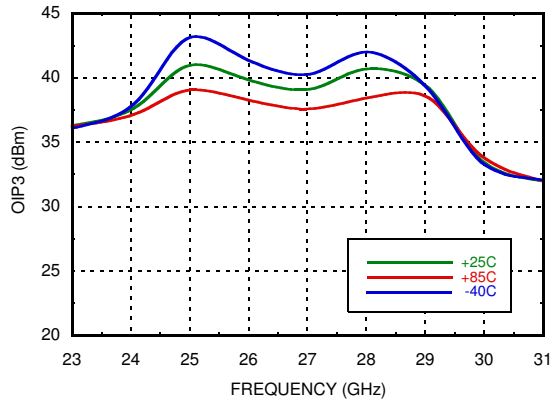

OIP3 vs. Vdd @ Pout / Tone = +14 dBm

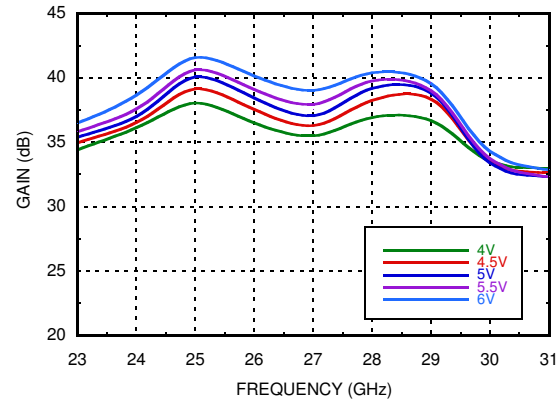

OIP3 vs. Idd @ Pout / Tone = +14 dBm

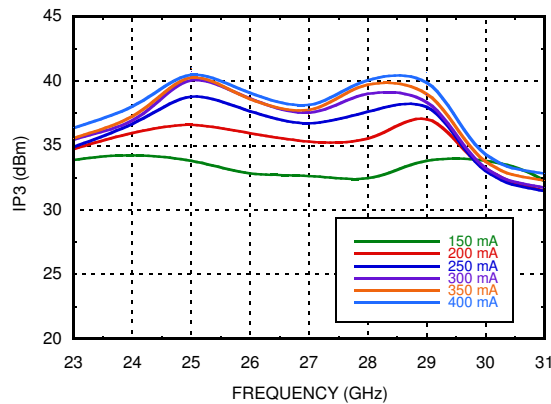

OIP3 vs. Pout / Tone

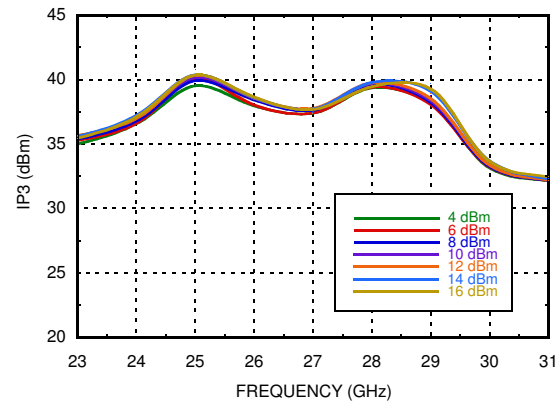

GaAs pHEMT MMIC 1/2 WATT POWER AMPLIFIER, 24 - 29.5 GHz

Output IM3

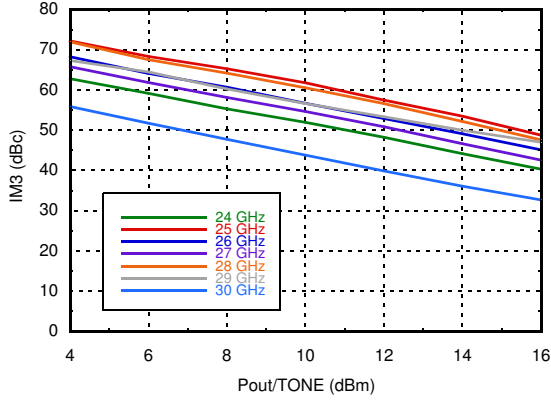

Output IM3 @ Vdd = +6.0 V, Idd = 350 mA

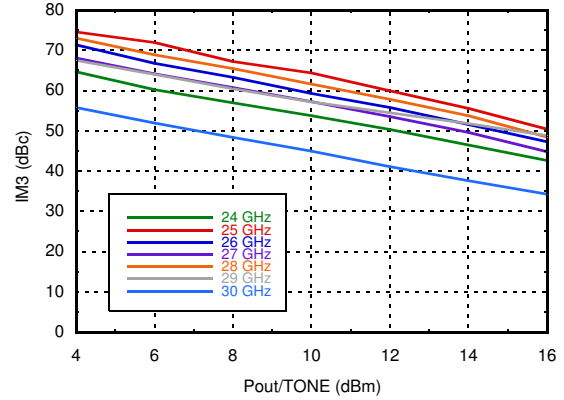

Igg vs. Input Power

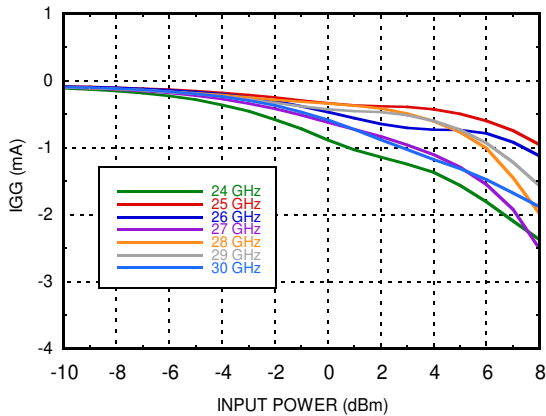

Idd vs. Vgg1, Representative of a Typical Device

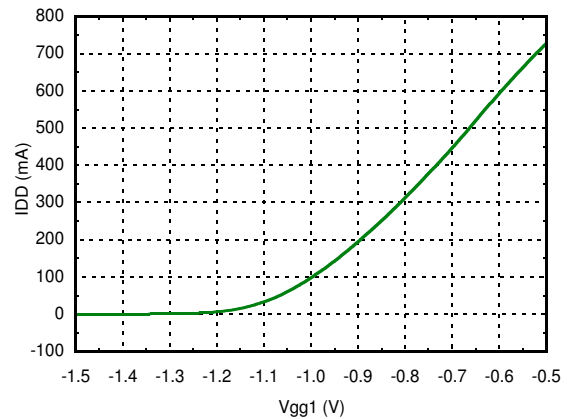

GaAs pHEMT MMIC 1/2 WATT POWER AMPLIFIER, 24 - 29.5 GHz

Absolute Maximum Ratings

Nominal Drain Supply to GND	+6.3 V
Gate Bias Voltage (V _{gg1})	-3.0 to 0 Vdc
Continuous P _{diss} (T= 85 °C) (derate 31.54 mW/°C above 85 °C)	2.88 W
RF Input Power	+26 dBm
Output Load VSWR	7:1
Storage Temperature	-65 to 150 °C
Operating Temperature	-40 to +85 °C
Max Peak Reflow Temperature	260 °C
ESD Sensitivity (HBM)	Class 1A - Passed 350V

Reliability Information

Junction Temperature to Main- tain 1 Million Hour MTTF	175 °C
Nominal Junction Temperature (T=85 °C, V _{dd} = +5.5 V)	145.06 °C
Thermal Resistance (channel to ground paddle)	31.2 °C/W

Stresses at or above those listed under Absolute Maximum Ratings may cause permanent damage to the product. This is a stress rating only, functional operation of the product at these or any other conditions above those indicated in the operational section of this specification is not implied. Operation beyond the maximum operating conditions for extended periods may affect product reliability.



ELECTROSTATIC SENSITIVE DEVICE
OBSERVE HANDLING PRECAUTIONS

Outline Drawing

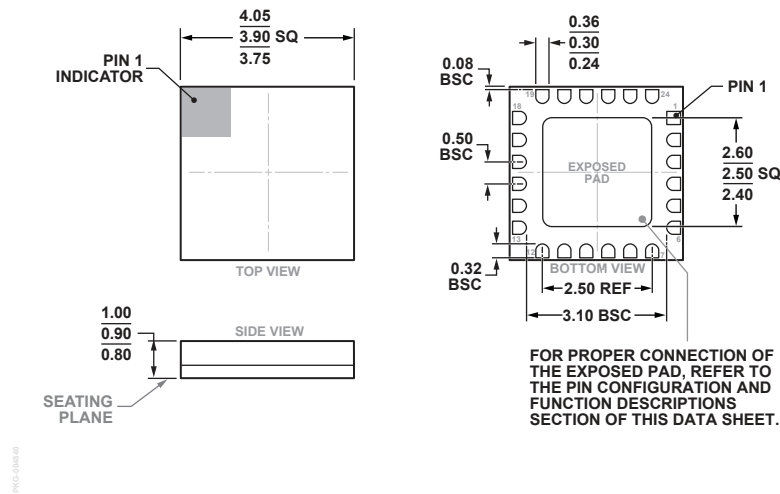

24-Terminal Ceramic Leadless Chip Carrier [LCC]
(E-24-1)

Dimensions shown in millimeters.



Package Information

Part Number	Package Body Material	Lead Finish	MSL Rating	Package Marking
HMC863ALC4	Alumina, White	Gold over Nickel	MSL3 ^[1]	H863A XXXX

[1] Max peak reflow temperature of 260 °C

GaAs pHEMT MMIC 1/2 WATT POWER AMPLIFIER, 24 - 29.5 GHz

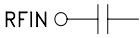
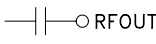
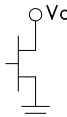
Pin Descriptions

Pin Number	Function	Description	Interface Schematic
1, 2, 4 - 7, 12 - 15, 17 - 19, 24 Package Bottom	GND	These pins & exposed ground paddle must be connected to RF/DC ground.	
3	RFIN	The pin is AC coupled and matched to 50 Ohms.	
8 - 11, 22, 21	N/C	These pins are not connected internally; however, all data shown herein was measured with these pins connected to RF/DC ground externally.	
16	RFOUT	The pin is AC coupled and matched to 50 Ohms.	
20	Vd	Drain bias for amplifier. External 100 pF, 0.1 uF and 4.7 uF bypass capacitors are required.	
23	Vgg1	Gate control for amplifier. Adjust VGG to achieve recommended bias current. External 100 pF, 0.1 uF and 4.7 uF bypass capacitors are required.	

GaAs pHEMT MMIC 1/2 WATT POWER AMPLIFIER, 24 - 29.5 GHz

Evaluation PCB

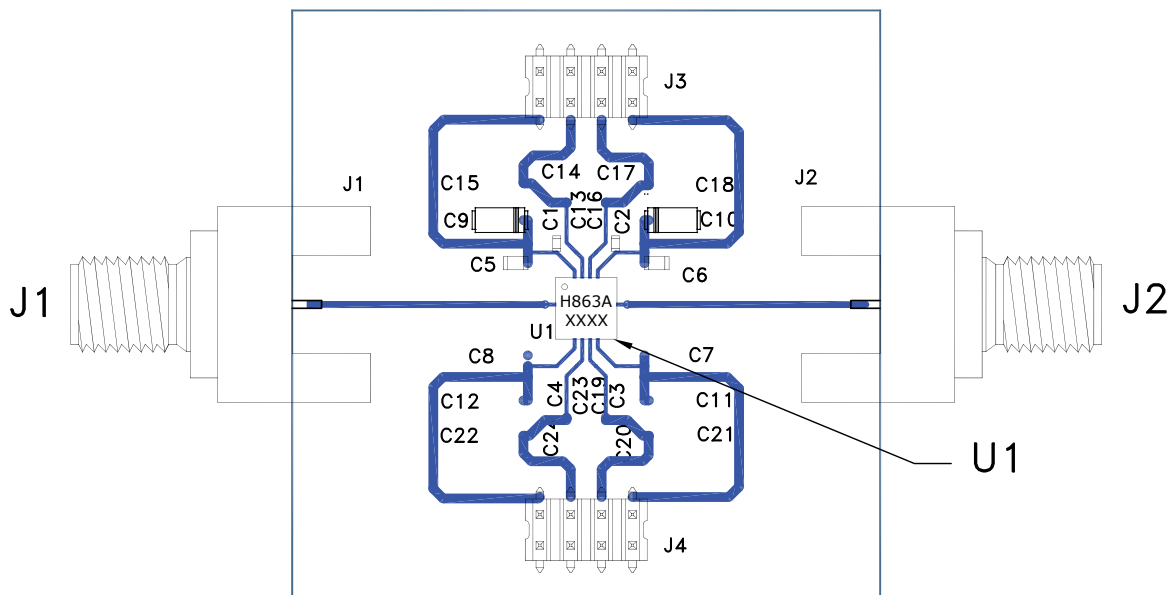

Evaluation Order Information

Item	Contents	Part Number
Evaluation PCB only	HMC863ALC4 Evaluation PCB	EV1HMC863ALC4

List of Materials for Evaluation Board

Item	Description
J1, J2	PCB Mount K Connectors
J3, J4	DC Pins
C1 - C2	100 pF Capacitor, 0402 Pkg.
C5 - C6	10 kF Capacitor, 0402 Pkg.
C9 - C10	4.7 μF Capacitor, 0402 Pkg
U1	HMC863ALC4 Power Amplifier
PCB [1]	08_046199

[1] Circuit Board Material: Rogers 4350 or Arlon FR4

The circuit board used in the application should use RF circuit design techniques. Signal lines should have 50 Ohm impedance while the package ground leads and exposed paddle should be connected directly to the ground plane similar to that shown. A sufficient number of via holes should be used to connect the top and bottom ground planes. The evaluation board should be mounted to an appropriate heat sink. The evaluation circuit board shown is available from Analog Devices, Inc.

**GaAs pHEMT MMIC 1/2 WATT
POWER AMPLIFIER, 24 - 29.5 GHz**

Application Circuit

