

CONFIGURATION OF CUSTOMER DOCUMENTS

P/N	DOCUMENTS	DWG. NO.	TITLE
HLW__R/S-2D7LF	SPEC	SC-HLW05	
	CONNECTOR	JSA96409	CAT NO.TABLE FOR 1mm SPACING CONNECTOR
		JSA96410	1mm SPACING CONNECTOR
		JSA96411	1mm SPACING CONNECTOR
	CABLE	JSA93382	RECOMMENDED CABLE(FPC)
		JSA93383	RECOMMENDED CABLE(FFC)
MANUAL	BJM-HLW101		

P/N	DOCUMENTS	DWG. NO.	TITLE
HLW__S-6D7LF	SPEC	SC-HLW06	
	CONNECTOR	JSA96412	CAT NO.TABLE FOR 1mm SPACING CONNECTOR
		JSA96413	1mm SPACING CONNECTOR
		JSA97169	1mm SPACING CONNECTOR
	CABLE	JSA93626	RECOMMENDED CABLE(C/C)
MANUAL	BJM-HLW102		



FCIconnect.com

Copyright FCI.

mat'l. code -				surface 58 / tolerance ISO 1302 / ISO 406 / ISO 1101		projection		product family 58PF/58QF		CODE JP	
Ltr	ecn no	dr	date	tolerances unless otherwise specified		mm		title 1mm SPACING CONNECTOR DOCUMENT LIST			
A	J05-0270	H.T	5/11/'05	angles	linear						
B	J05-293	N.S	5/18/'05								
C	J05-0517	N.S	8/11/'05			scale X		dwg no JSA 96417 sheet 1 of 1 size A4 type Product Customer Drawing			
D	J06-0238	M.M	6/8/'06	dr	H.YAMASHITA 2009-6-29						
E	J09-0255	M.Y	2009-6-29	enr	H.YAMASHITA 2009-6-29						
				chr	S. W. Miller 2009-6-29						
				appd	J. Cladoniz 2009-6-29						
sheet index	revision sheet	E	1								Rev. E

CAT. NO. & DIMENSIONS

NO. OF CONTACTS (n)	CAT. NO.	CAT. NO.	DIMENSIONS (NOTE1)		
	RIGHT ANGLE TYPE	STRAIGHT TYPE	A ± 0.3	B ± 0.1	C
4	HLW 4R-2D7LF	HLW 4S-2D7LF	6.6	5.12	3.0
5	HLW 5R-2D7LF	HLW 5S-2D7LF	7.6	6.12	4.0
6	HLW 6R-2D7LF	HLW 6S-2D7LF	8.6	7.12	5.0
7	HLW 7R-2D7LF	HLW 7S-2D7LF	9.6	8.12	6.0
8	HLW 8R-2D7LF	HLW 8S-2D7LF	10.6	9.12	7.0
9	HLW 9R-2D7LF	HLW 9S-2D7LF	11.6	10.12	8.0
10	HLW10R-2D7LF	HLW10S-2D7LF	12.6	11.12	9.0
11	HLW11R-2D7LF	HLW11S-2D7LF	13.6	12.12	10.0
12	HLW12R-2D7LF	HLW12S-2D7LF	14.6	13.12	11.0
13	HLW13R-2D7LF	HLW13S-2D7LF	15.6	14.12	12.0
14	HLW14R-2D7LF	HLW14S-2D7LF	16.6	15.12	13.0
15	HLW15R-2D7LF	HLW15S-2D7LF	17.6	16.12	14.0
16	HLW16R-2D7LF	HLW16S-2D7LF	18.6	17.12	15.0
17	HLW17R-2D7LF	HLW17S-2D7LF	19.6	18.12	16.0
18	HLW18R-2D7LF	HLW18S-2D7LF	20.6	19.12	17.0
19	HLW19R-2D7LF	HLW19S-2D7LF	21.6	20.12	18.0
20	HLW20R-2D7LF	HLW20S-2D7LF	22.6	21.12	19.0
21	HLW21R-2D7LF	HLW21S-2D7LF	23.6	22.12	20.0
22	HLW22R-2D7LF	HLW22S-2D7LF	24.6	23.12	21.0
23	HLW23R-2D7LF	HLW23S-2D7LF	25.6	24.12	22.0
24	HLW24R-2D7LF	HLW24S-2D7LF	26.6	25.12	23.0
25	HLW25R-2D7LF	HLW25S-2D7LF	27.6	26.12	24.0
26	HLW26R-2D7LF	HLW26S-2D7LF	28.6	27.12	25.0
27	HLW27R-2D7LF	HLW27S-2D7LF	29.6	28.12	26.0
28	HLW28R-2D7LF	HLW28S-2D7LF	30.6	29.12	27.0
29	HLW29R-2D7LF	HLW29S-2D7LF	31.6	30.12	28.0
30	HLW30R-2D7LF	HLW30S-2D7LF	32.6	31.12	29.0
31	HLW31R-2D7LF	HLW31S-2D7LF	33.6	32.12	30.0
32	HLW32R-2D7LF	HLW32S-2D7LF	34.6	33.12	31.0

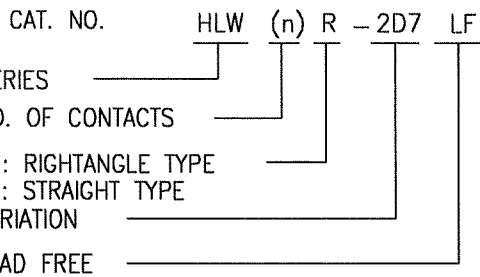

NOTES

1. SEE PART DRAWINGS FOR DIMENSIONS A~C.

mat'l. code				surface ⁵⁸ / tolerance ISO 406 ISO 1101		projection		product family 58PF/QF		CODE JP	
ltr	ecn no	dr	date	tolerances unless otherwise specified				title CAT NO. TABLE FOR 1mm SPACING CONNECTOR (CAT NO. HLW__R/S-2D7LF)			
A	J05-0270	H.T	5/10/05	angles	linear	mm					
B	J06-0449	H.T	11/2/06			scale X					
		dr	<i>H. Hoshino 11/2/06</i>					dwg no JSA 96409		sheet 1 of 1 size A4	
		enr	<i>H. Hoshino 11/2/06</i>					type Product Customer Drawing			
		chr	<i>R. Shoyu 11/2/06</i>								
		appd	<i>S. Andam 11/7/06</i>								
sheet index	revision	B									Rev. B
	sheet	1									

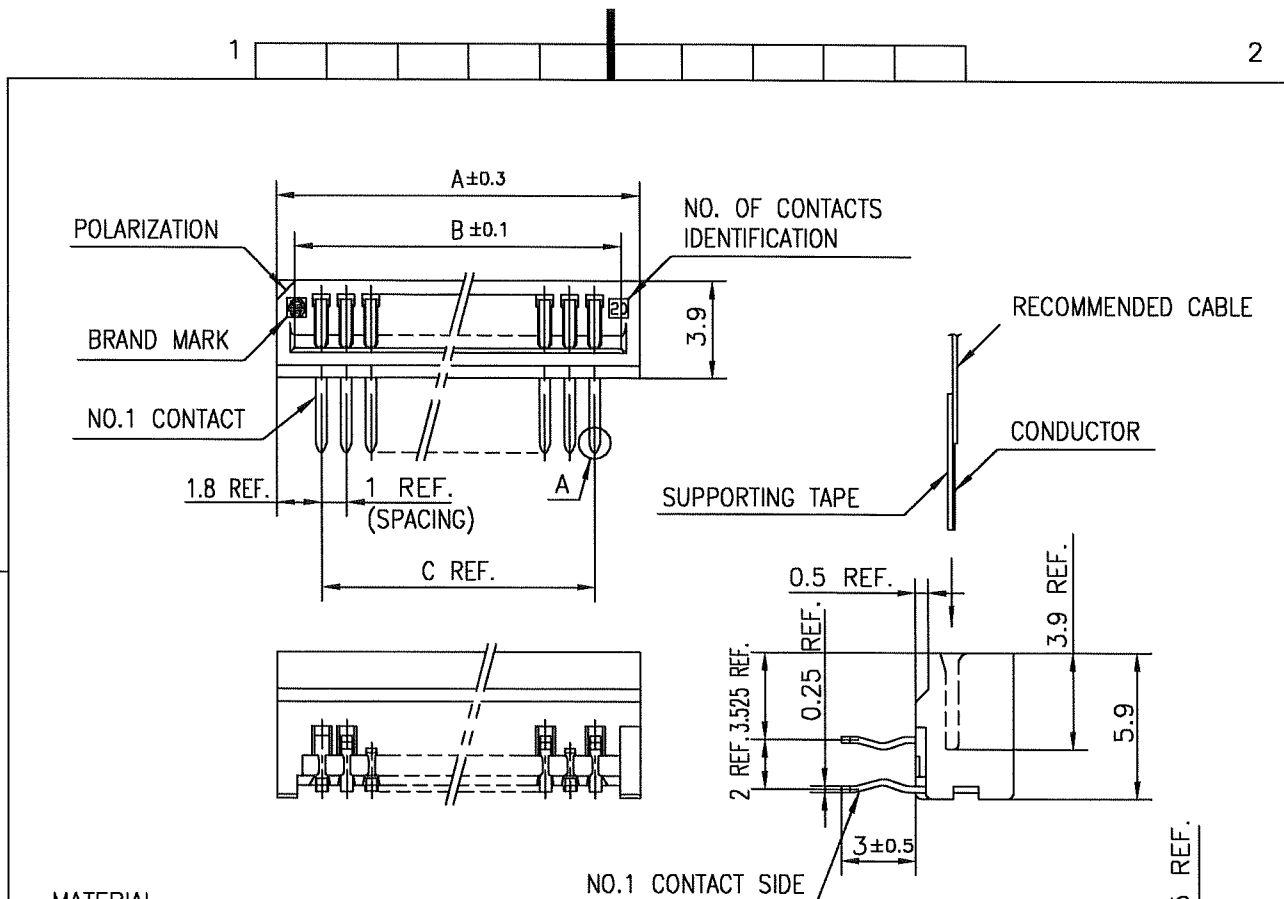

MATERIAL

INSULATOR : PBT RESIN GLASS REINFORCED (UL94V-0)
 COLOR : BLACK
 CONTACT : PHOSPHOR BRONZE
 PLATING : TIN

NOTE

1. THIS PRODUCT IS RIGHT ANGLE TYPE CONNECTOR.
2. THIS PRODUCT MEETS EUROPEAN UNION DIRECTIVES AND OTHER COUNTRY REGULATIONS AS DESCRIBED IN GS-22-008.
3. THE HOUSING WILL WITHSTAND EXPOSURE TO 260°C PEAK TEMPERATURE FOR 10 SECONDS IN A WAVE SOLDER APPLICATION WITH A 1.6mm THICK CIRCUIT BOARD.

RECOMMENDED PC BOARD

THICKNESS : 1.2~1.6
 HOLE PATTERN (COMPONENT SIDE)

n:NO.OF CONTACTS

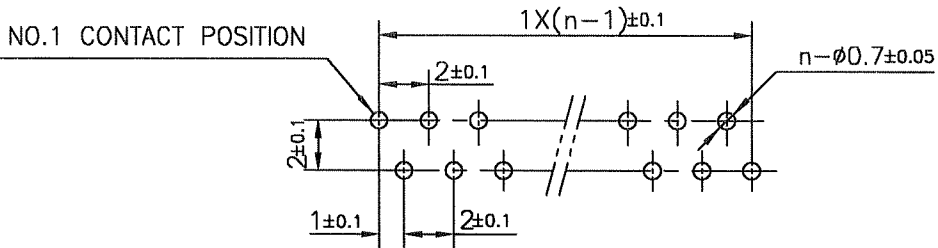

mat'l. code				surface 58 / tolerance ISO 406 / ISO 1302 / ISO 1101		projection		product family 58PF		CODE JP	
ltr	ecn no	dr	date	tolerances unless otherwise specified		mm		title			
A	J05-0270	H.T	5/10/05	±0.2		mm		1mm SPACING CONNECTOR FOR FPC/FFC (CAT NO. HLW__R-2D7LF)			
B	J05-0735	H.T	10/28/05	angles	linear	mm					
C	J06-0449	H.T	11/2/06			scale X					
				dr	11/2/06			dwg no		sheet 1 of 1 size	
				enr	11/2/06			JSA 96410		A4	
				chr	11/2/06			type		Product Customer Drawing	
				appd	11/7/06						
sheet index	revision	C									Rev. C
	sheet	1									

SC-HLW05 JSA96409 Form: A4

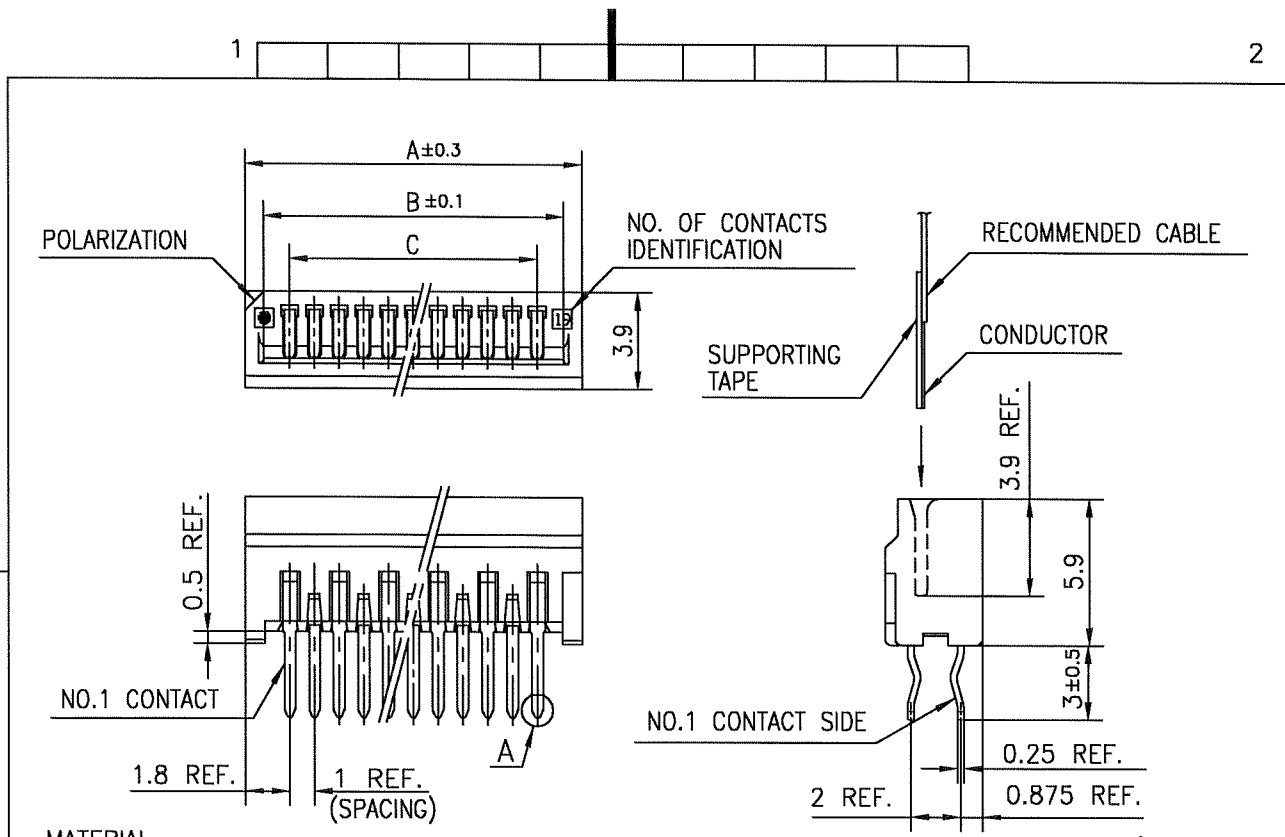

MATERIAL

INSULATOR : PBT RESIN GLASS REINFORCED (UL94V-0)
 COLOR : BLACK
 CONTACT : PHOSPHOR BRONZE
 PLATING : TIN

NOTE

- 1.THIS PRODUCT IS STRAIGHT TYPE CONNECTOR.
- 2.THIS PRODUCT MEETS EUROPEAN UNION DIRECTIVES AND OTHER COUNTRY REGULATIONS AS DESCRIBED IN GS-22-008.
- 3.THE HOUSING WILL WITHSTAND EXPOSURE TO 260°C PEAK TEMPERATURE FOR 10 SECONDS IN A WAVE SOLDER APPLICATION WITH A 1.6mm THICK CIRCUIT BOARD.

RECOMMENDED PC BOARD

THICKNESS : 1.2~1.6
 HOLE PATTERN (COMPONENT SIDE)

n:NO.OF CONTACTS

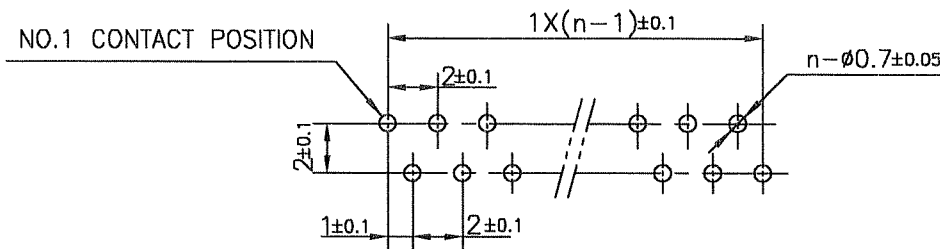

mat'l. code				surface 58 ISO 1302 ✓	tolerance ISO 406 ISO 1101	projection mm	product family 58QF	CODE JP	
ltr	ecn no	dr	date	tolerances unless otherwise specified		mm	title 1mm SPACING CONNECTOR FOR FPC/FFC (CAT NO. HLW__S-2D7LF)		
A	J05-0270	H.T	5/10/05	angles	±0.2		scale X	dwg no JSA 96411	sheet 1 of 1 size A4
B	J05-0735	H.T	10/28/05		linear				
C	J06-0449	H.T	11/2/06	dr		FCJ			
				enrg					
				chr					
				appd					
sheet index	revision sheet	C	1					Rev. C	

SC-HLW05 JSA96409
 form: A4

RECOMMENDED CABLE (FPC)

n : NO. OF CONDUCTORS

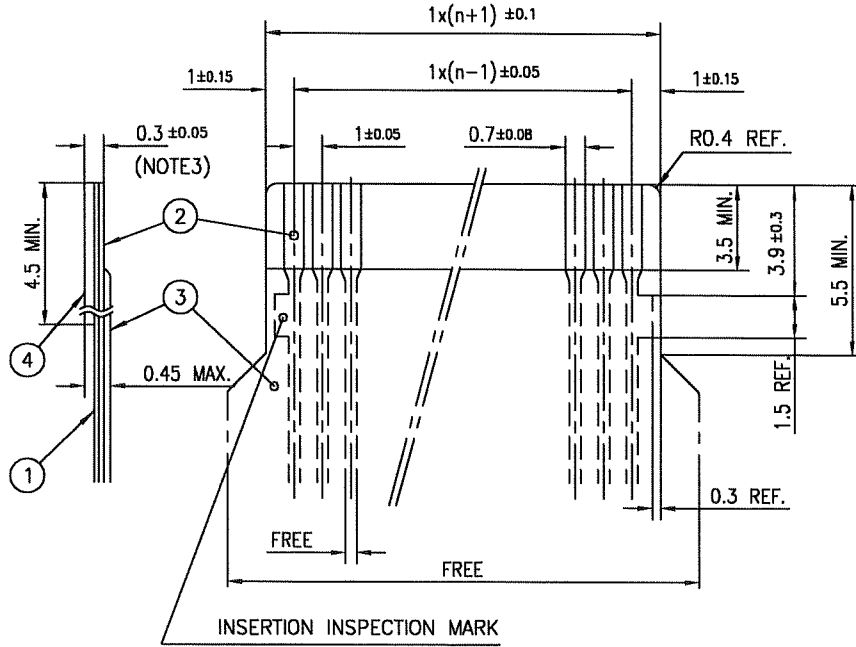

PT. NO.	DESCRIPTION	MATERIAL	THICKNESS (μm)
1	BASE FILM	POLYIMIDE OR POLYESTER OR EQUIVALENT	25
2	CONDUCTOR	COPPER FOIL (PLATING : SOLDER 1μm MIN.)	35
3	OVERLAY	POLYIMIDE OR POLYESTER OR EQUIVALENT	—
4	SUPPORTING TAPE	POLYESTER OR POLYIMIDE OR EQUIVALENT	188

NOTES

1. NO BURR AT EACH PORTION.
2. NO PEELING IN COMMON USE.
3. TOTAL THICKNESS LIMIT OF EACH MATERIAL (INCLUDING ADHESIVE AGENT) IS SPECIFIED.

mat'l. code				surface 58 / tolerance ISO 406 ISO 1101		projection		product family 58PF/QF		CODE JP	
litr ecn no dr date				tolerances unless otherwise specified		mm		title			
AA J05-0270 H.T 5/11/05				angles linear		mm		RECOMMENDED CABLE (FPC)			
AB J06-0449 H.T 11/2/06						scale X		(Cat. No. HLW__R/S-___)			
				dr		FCI		dwg no		sheet 1 of 1 size	
				enr				JSA 93382		A4	
				chr				type Product Customer Drawing			
				appd							
sheet index		revision sheet		AB 1						Rev. AB	



FCIconnect.com

Copyright FCI.

RECOMMENDED CABLE (FFC)

n : NO. OF CONDUCTORS

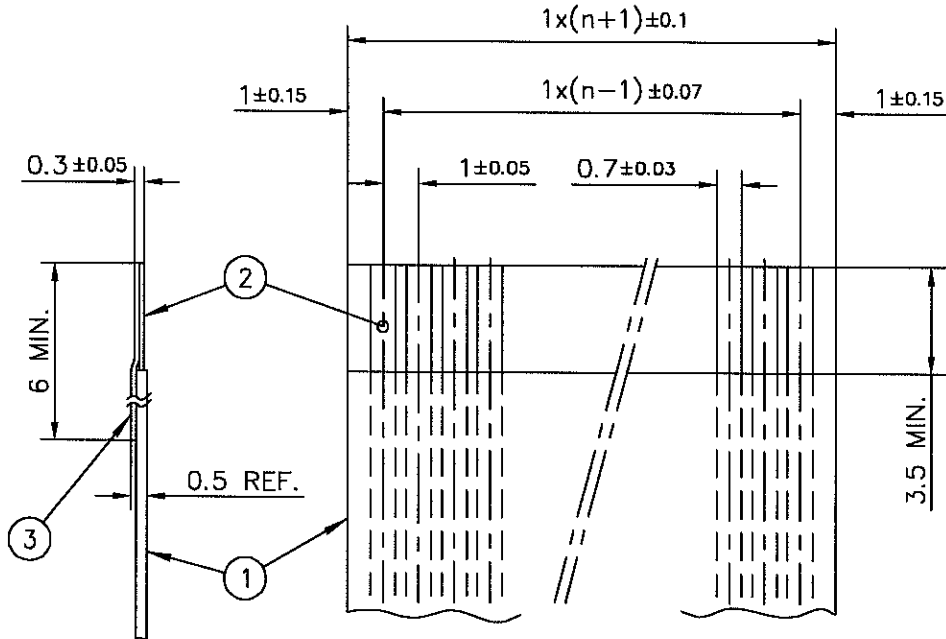

PT. NO.	DESCRIPTION	MATERIAL	NOTE
1	INSULATOR	FLAME RESISTING POLYESTER OR EQUIVALENT	_____
2	CONDUCTOR	COPPER FOIL	PLATING : TIN OR SOLDER 1 μm MIN.
3	SUPPORTING TAPE	FLAME RESISTING POLYESTER OR EQUIVALENT	_____

NOTES

1. NO BURR AT EACH PORTION.
2. NO PEELING IN COMMON USE.

mat'l. code				surface 58 / tolerance ISO 1302 / ISO 406 / ISO 1101		projection		product family 58PF/QF		CODE JP	
litr ecn no dr date				tolerances unless otherwise specified		mm		title			
AA J05-0270 H.T 5/11/05				angles linear		mm		RECOMMENDED CABLE (FFC)			
AB J06-0449 H.T 11/2/06						scale X		(Cat. No. HLW__R/S-__)			
				dr 11/2/06		FCI		dwg no sheet 1 of 1 size			
				enr 11/2/06				JSA 93383		A4	
				chr R. Shouji 11/2/06				type Product Customer Drawing			
				appd S. De. davar 11/2/06							
sheet index		revision sheet		AB 1						Rev AB	

CAT. NO. & DIMENSIONS

NO. OF CONTACTS (n)	CAT. NO.		DIMENSIONS (NOTE1)		
	STRAIGHT TYPE	RIGHT ANGLE TYPE	A ± 0.3	B ± 0.1	C
4	HLW 4S-6D7LF	HLW 4R-6D7LF	6.6	5.12	3.0
5	HLW 5S-6D7LF	HLW 5R-6D7LF	7.6	6.12	4.0
6	HLW 6S-6D7LF	HLW 6R-6D7LF	8.6	7.12	5.0
7	HLW 7S-6D7LF	HLW 7R-6D7LF	9.6	8.12	6.0
8	HLW 8S-6D7LF	HLW 8R-6D7LF	10.6	9.12	7.0
9	HLW 9S-6D7LF	HLW 9R-6D7LF	11.6	10.12	8.0
10	HLW 10S-6D7LF	HLW 10R-6D7LF	12.6	11.12	9.0
11	HLW 11S-6D7LF	HLW 11R-6D7LF	13.6	12.12	10.0
12	HLW 12S-6D7LF	HLW 12R-6D7LF	14.6	13.12	11.0
13	HLW 13S-6D7LF	HLW 13R-6D7LF	15.6	14.12	12.0
14	HLW 14S-6D7LF	HLW 14R-6D7LF	16.6	15.12	13.0
15	HLW 15S-6D7LF	HLW 15R-6D7LF	17.6	16.12	14.0
16	HLW 16S-6D7LF	HLW 16R-6D7LF	18.6	17.12	15.0
17	HLW 17S-6D7LF	HLW 17R-6D7LF	19.6	18.12	16.0
18	HLW 18S-6D7LF	HLW 18R-6D7LF	20.6	19.12	17.0
19	HLW 19S-6D7LF	HLW 19R-6D7LF	21.6	20.12	18.0
20	HLW 20S-6D7LF	HLW 20R-6D7LF	22.6	21.12	19.0
21	HLW 21S-6D7LF	HLW 21R-6D7LF	23.6	22.12	20.0
22	HLW 22S-6D7LF	HLW 22R-6D7LF	24.6	23.12	21.0
23	HLW 23S-6D7LF	HLW 23R-6D7LF	25.6	24.12	22.0
24	HLW 24S-6D7LF	HLW 24R-6D7LF	26.6	25.12	23.0
25	HLW 25S-6D7LF	HLW 25R-6D7LF	27.6	26.12	24.0
26	HLW 26S-6D7LF	HLW 26R-6D7LF	28.6	27.12	25.0
27	HLW 27S-6D7LF	HLW 27R-6D7LF	29.6	28.12	26.0
28	HLW 28S-6D7LF	HLW 28R-6D7LF	30.6	29.12	27.0
29	HLW 29S-6D7LF	HLW 29R-6D7LF	31.6	30.12	28.0
30	HLW 30S-6D7LF	HLW 30R-6D7LF	32.6	31.12	29.0
31	HLW 31S-6D7LF	HLW 31R-6D7LF	33.6	32.12	30.0
32	HLW 32S-6D7LF	HLW 32R-6D7LF	34.6	33.12	31.0



FCIconnect.com

Copyright FCI.

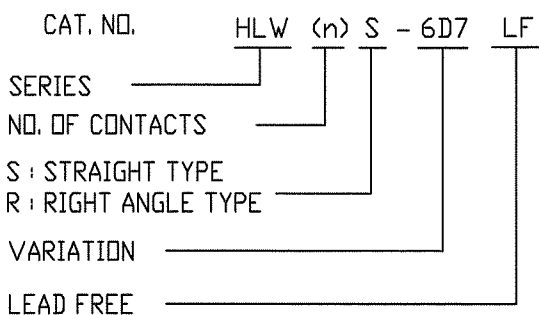

NOTES

1. SEE PART DRAWINGS FOR DIMENSIONS A~C.

mat'l. code -				surface 58 / tolerance ISO 1302 / ISO 406 / ISO 1101		projection		product family 58PF/58QF		CODE JP	
ltr ecn no dr date				tolerances unless otherwise specified		mm		title			
A J05-0270 H.T 5/10/'05				angles linear		scale X		CAT NO. TABLE FOR 1mm SPACING CONNECTOR (CAT NO. HLW__R/S-6D7LF)			
B J06-0238 M.M 6/8/'06								dwg no		sheet 1 of 1	
C J09-0255 M.Y 2009-6-29								JSA 96412		A4	
				dr M.YAMAGUCHI 2009-6-29		FCI		type Product Customer Drawing			
				engr M.YAMAGUCHI 2009-6-29							
				chr S. W. Chai 2009-6-29							
				appd P. Nudwin 2009-6-29							
sheet index		revision sheet		C 1						Rev. C	

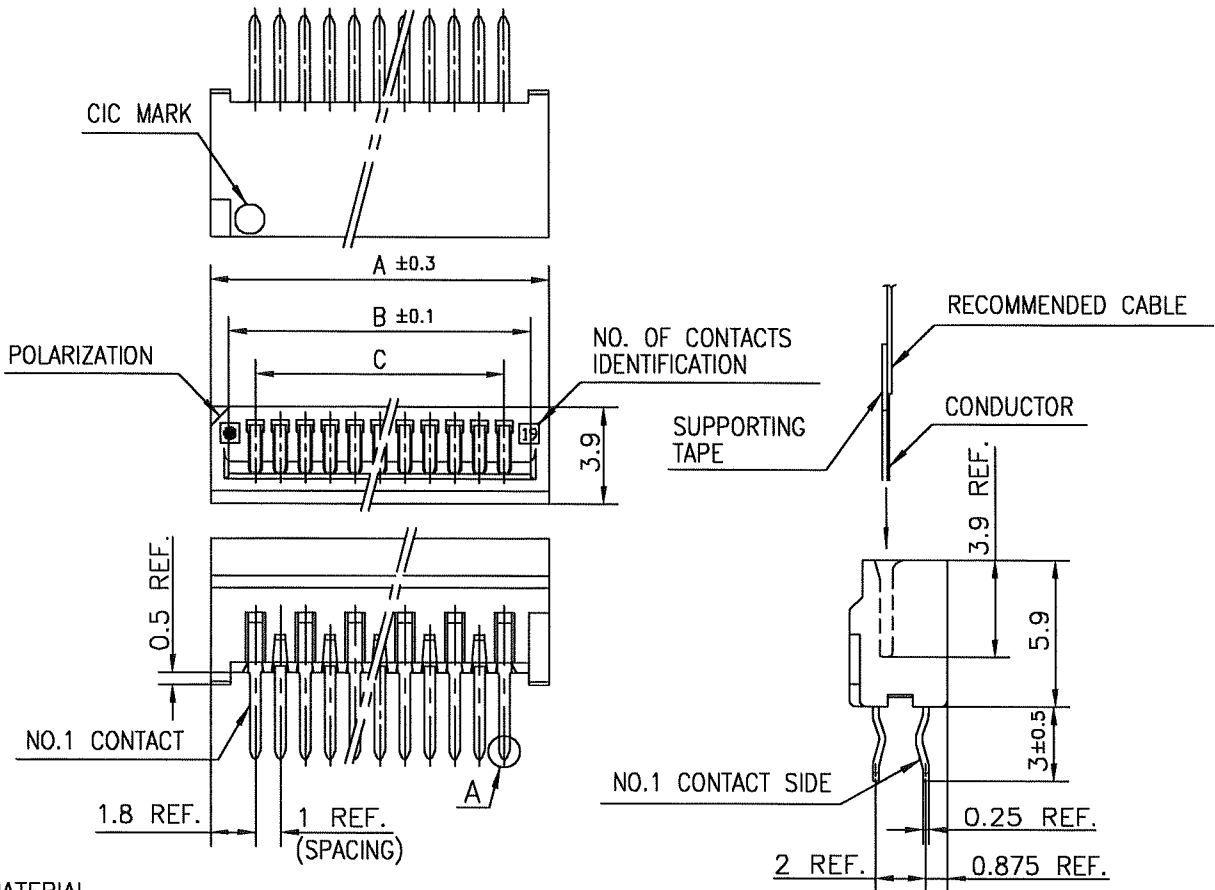

MATERIAL

INSULATOR : PBT RESIN GLASS REINFORCED (UL94V-0)
 COLOR : BLACK
 CONTACT : PHOSPHOR BRONZE
 PLATING : TIN

NOTE

- 1.THIS PRODUCT IS STRAIGHT TYPE CONNECTOR.
- 2.THIS PRODUCT MEETS EUROPEAN UNION DIRECTIVES AND OTHER COUNTRY REGULATIONS AS DESCRIBED IN GS-22-008.
- 3.THE HOUSING WILL WITHSTAND EXPOSURE TO 260°C PEAK TEMPERATURE FOR 10 SECONDS IN A WAVE SOLDER APPLICATION WITH A 1.6mm THICK CIRCUIT BOARD.

RECOMMENDED PC BOARD

THICKNESS : 1.2~1.6
 HOLE PATTERN (COMPONENT SIDE)

NO.1 CONTACT POSITION

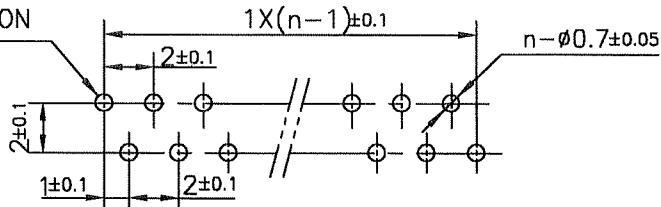

n:NO.OF CONTACTS

mat'l. code				surface 58 / tolerance ISO 406 / ISO 1302 / ISO 1101		projection		product family 58QF		CODE JP	
ltr	ecn no	dr	date	tolerances unless otherwise specified		mm		title			
A	J05-0270	H.T	5/10/05	±0.2		mm		1mm SPACING CONNECTOR FOR CIC (CAT NO. HLW__S-6D7LF)			
B	J05-0735	H.T	10/28/05	linear		scale X		dwg no JSA 96413 sheet 1 of 1 size A4			
C	J06-0449	H.T	11/2/06	dr		FCI		type Product Customer Drawing			
sheet index		revision sheet		C 1						Rev. C	



FCIconnect.com

Copyright FCI.

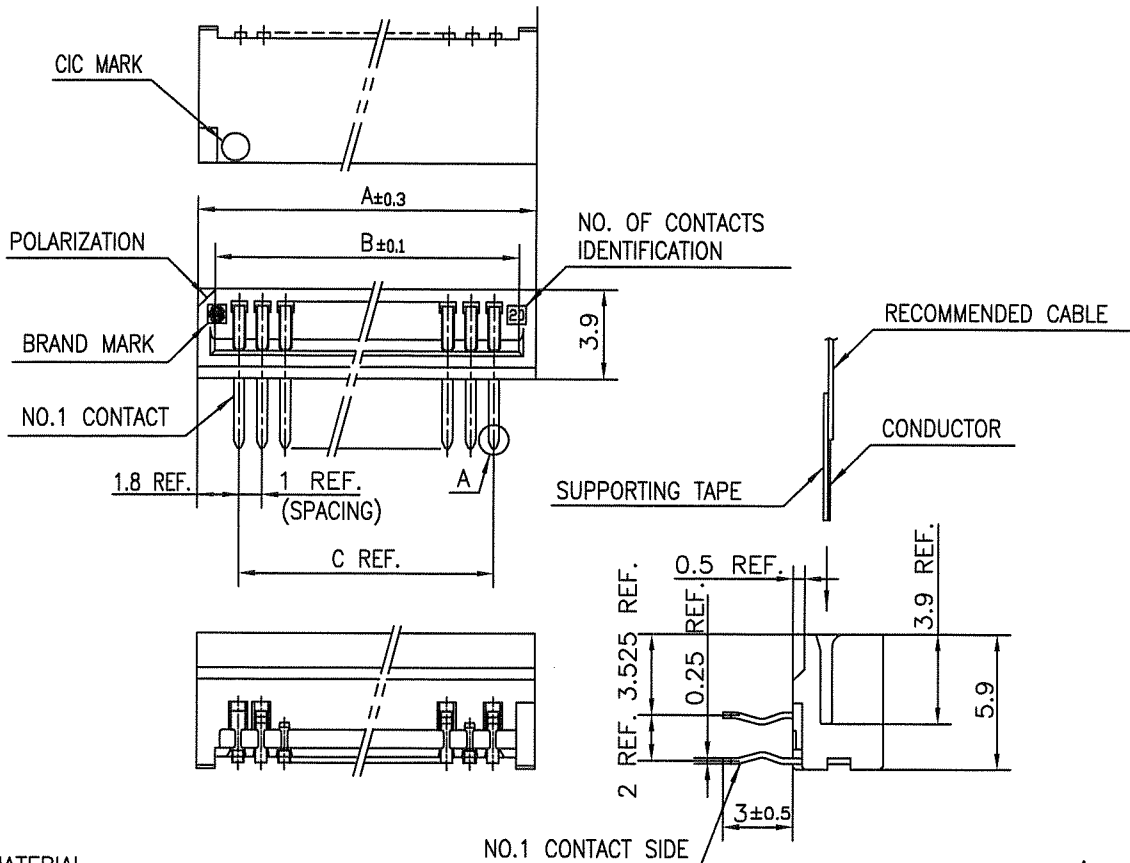

MATERIAL

INSULATOR : PBT RESIN GLASS REINFORCED (UL94V-0)
 COLOR : BLACK
 CONTACT : PHOSPHOR BRONZE
 PLATING : TIN

NOTE

1. THIS PRODUCT IS RIGHT ANGLE TYPE CONNECTOR.
2. THIS PRODUCT MEETS EUROPEAN UNION DIRECTIVES AND OTHER COUNTRY REGULATIONS AS DESCRIBED IN GS-22-008.
3. THE HOUSING WILL WITHSTAND EXPOSURE TO 260°C PEAK TEMPERATURE FOR 10 SECONDS IN A WAVE SOLDER APPLICATION WITH A 1.6mm THICK CIRCUIT BOARD.

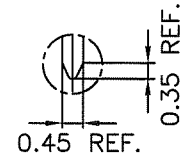

DETAIL A

RECOMMENDED PC BOARD

THICKNESS : 1.2~1.6
 HOLE PATTERN (COMPONENT SIDE)

n:NO.OF CONTACTS

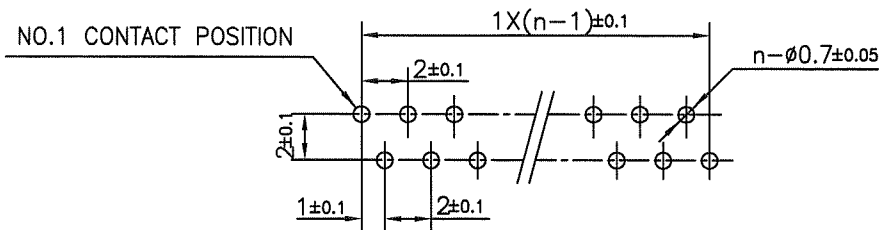

mat'l. code				surface 58 / tolerance ISO 1302 / ISO 406 / ISO 1101		projection		product family		CODE		
-				tolerances unless otherwise specified		mm		58PF		JP		
ltr	ecn no	dr	date	angles	linear	mm		title				
A	J06-0238	M.M	6/8/'06			mm		1mm SPACING CONNECTOR FOR CIC (CAT NO. HLW__R-6D7LF)				
B	J09-0255	M.Y	2009-6-29			scale %		dwg no sheet 1 of 1 size				
				dr	M.YAMASHITA	2009-6-29	FCJ	JSA 97169		A4		
				enr	M.YAMASHITA	2009-6-29		type Product Customer Drawing				
				chr	S. W. H. L.	2009-6-29						
				appd	S. W. H. L.	2009-6-29						
sheet index	revision sheet	B	1									Rev. B



FCJconnect.com

Copyright FCI.

RECOMMENDED CABLE (CIC)

n : NO. OF CONDUCTORS

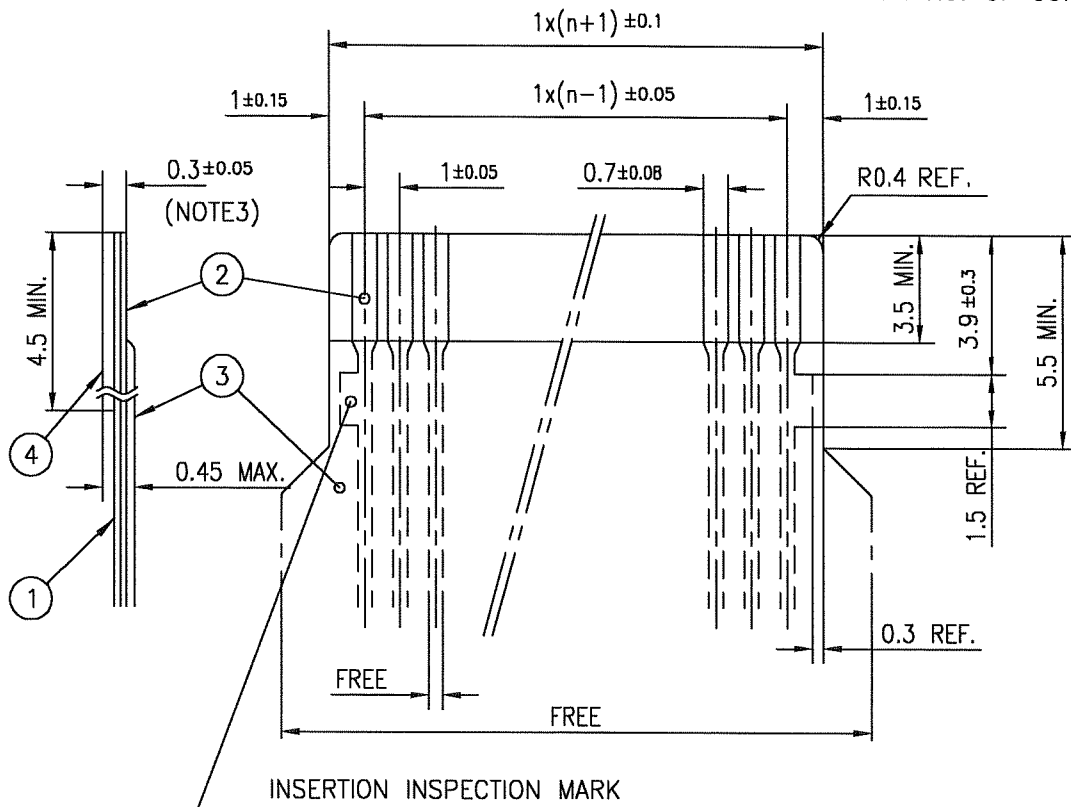

PT. NO.	DESCRIPTION	MATERIAL	THICKNESS (μm)	
1	BASE FILM	POLYESTER OR EQUIVALENT	75	25
2	CONDUCTOR	CARBON PASTE OVER SILVER PASTE	10 MIN.	
3	OVERLAY	POLYIMIDE OR POLYESTER OR EQUIVALENT	—	
4	SUPPORTING TAPE	POLYESTER OR POLYIMIDE OR EQUIVALENT	188	250

NOTES

1. NO BURR AT EACH PORTION.
2. NO PEELING IN COMMON USE.
3. TOTAL THICKNESS LIMIT OF EACH MATERIAL (INCLUDING ADHESIVE AGENT) IS SPECIFIED.

mat'l. code				surface ISO 1302 ✓		tolerance ISO 406 ✓ ISO 1101		projection		product family 58PF/QF		CODE JP			
ltr	ecn no	dr	date	tolerances unless otherwise specified						title					
AA	J05-0270	H.T	5/11/05	angles		linear		mm		RECOMMENDED CABLE (CIC)					
AB	J06-0449	H.T	11/2/06							(Cat. No. HLW__R/S-__)					
				dr <i>H. Shouji</i> 11/2/06		engr <i>H. Shouji</i> 11/2/06				dwg no		sheet 1 of 1		size	
				chr <i>K. Shouji</i> 11/2/06		appd <i>S. Nakano</i> 11/7/06				JSA 93626				A4	
sheet index		revision sheet		AB										Rev. AB	



FCIconnect.com

Copyright FCI.