

## Wideband, 4 x 1 Video

## Crosspoint Switch with Tally Outputs

July 1995

### Features

- Low Power Dissipation ..... 105mW
- Symmetrical Slew Rates ..... 1250V/ $\mu$ s
- 0.1dB Gain Flatness ..... 165MHz
- -3dB Bandwidth ..... 330MHz
- Off Isolation (100MHz) ..... .70dB
- Crosstalk Rejection (30MHz) ..... .80dB
- Differential Gain and Phase ..... 0.01%/0.01 Degrees
- High ESD Rating ..... >2000V
- TTL Compatible Control Inputs
- Open Collector Tally Outputs
- Improved Replacement for GX4404

### Applications

- Professional Video Switching and Routing
- HDTV
- Computer Graphics
- RF Switching and Routing

### Description

The HA4404 is a very wide bandwidth 4 x 1 crosspoint switch ideal for professional video switching, HDTV, computer monitor routing, and other high performance applications. The circuit features very low power dissipation (105mW Enabled, 4mW Disabled), excellent differential gain and phase, and very high off isolation. When disabled, the output is switched to a high impedance state, making the HA4404 ideal for routing matrix equipment.

The HA4404 requires no external current source, and features fast switching and symmetric slew rates. The tally outputs are open collector PNP transistors to  $V_{CC}$  to provide an indication of crosspoint selection.

The only difference between the HA4404 and HA4404A is that the A grade part has lower disabled output capacitance.

For a 4 x 1 crosspoint without Tally outputs or with synchronous control signals, please refer to the HA4314A and HA4344A Data Sheets, respectively.

### Ordering Information

PART NUMBER	TEMPERATURE RANGE	PACKAGE
HA4404CB	0°C to +70°C	16 Lead Plastic SOIC (N)
HA4404ACP	0°C to +70°C	16 Lead Plastic DIP
HA4404ACB	0°C to +70°C	16 Lead Plastic SOIC (N)

### Pinout

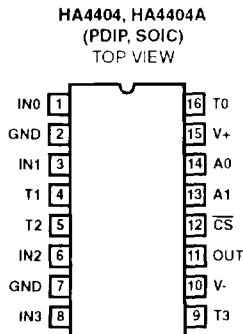

### Functional Diagram

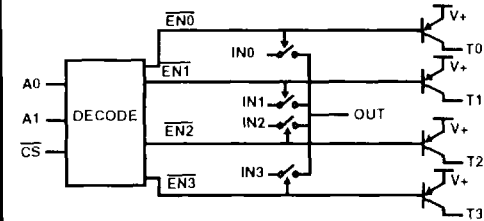

### Truth Table

$\overline{CS}$	A1	A0	OUT	ACTIVE TALLY OUTPUT
0	0	0	IN0	T0
0	0	1	IN1	T1
0	1	0	IN2	T2
0	1	1	IN3	T3
1	X	X	High - Z	None, All High - Z

## Specifications HA4404, HA4404A

### Absolute Maximum Ratings

Voltage Between V+ and V-	±12V
Input Voltage	V <sub>SUPPLY</sub>
Digital Input Current (Note 2)	±25mA
Analog Input Current (Note 2)	±5mA
Output Current	20mA
Junction Temperature (Die Only)	+175°C
Junction Temperature (Plastic Package)	+150°C
Lead Temperature (Soldering 10s) (SOIC - Lead Tips Only)	+300°C

### Operating Conditions

Operating Temperature Range	HA4404C, HA4404AC	-40°C to T <sub>A</sub> +70°C
Storage Temperature		-65°C to T <sub>A</sub> +150°C
Thermal Package Characteristics (°C/W)		
Plastic DIP Package		90
SOIC Package		115

*CAUTION: Stresses above those listed in "Absolute Maximum Ratings" may cause permanent damage to the device. This is a stress only rating and operation of the device at these or any other conditions above those indicated in the operational sections of this specification is not implied.*

### Electrical Specifications V<sub>SUPPLY</sub> = ±5V, R<sub>I</sub> = 10kΩ, V<sub>OS</sub> = 0.8V, Unless Otherwise Specified

PARAMETER	(NOTE 3) TEMPERATURE	HA4404C, HA4404AC			UNITS	
		MIN	TYP	MAX		
<b>DC SUPPLY CHARACTERISTICS</b>						
Supply Voltage	Full	+4.5	±5.0	+5.5	V	
Supply Current (V <sub>OUT</sub> = 0V)	V <sub>OS</sub> = 0.8V	+25°C, -70°C	-	10.5	13	mA
	V <sub>OS</sub> = 0.8V	0°C	-	-	15.5	mA
	V <sub>OS</sub> = 2.0V	+25°C, +70°C	-	400	450	μA
	V <sub>OS</sub> = 2.0V	0°C	-	400	580	μA
<b>ANALOG DC CHARACTERISTICS</b>						
Output Voltage Swing without Clipping (V <sub>OUT</sub> = V <sub>IN</sub> + V <sub>IO</sub> + 20mV)	+25°C, +70°C	+2.7	+2.8	-	V	
	0°C	+2.4	+2.5	-	V	
Output Current	Full	15	20	-	mA	
Input Bias Current	Full	-	30	50	μA	
Output Offset Voltage	Full	-10	-	10	mV	
Output Offset Voltage Drift (Note 1)	Full	-	25	50	μV/°C	
<b>SWITCHING CHARACTERISTICS</b>						
Turn-On Time	+25°C	-	160	-	ns	
Turn-Off Time	+25°C	-	320	-	ns	
Output Glitch During Switching	+25°C	-	+10	-	mV	
<b>DIGITAL DC CHARACTERISTICS</b>						
Input Logic High Voltage	Full	2	-	-	V	
Input Logic Low Voltage	Full	-	-	0.8	V	
Input Current (0V to 4V)	Full	-2	-	2	μA	
Tally Output High Voltage (I <sub>OH</sub> = 1mA)	Full	4.7	4.8	-	V	
Tally Off Leakage Current (V <sub>I(A),Y</sub> = 0V)	Full	-20	-	20	μA	
<b>AC CHARACTERISTICS</b>						
Insertion Loss (±1V)	+25°C	-	0.055	0.063	dB	
	Full	-	0.07	0.08	dB	
Channel-to-Channel Insertion Loss Match	Full	-	+0.004	+0.006	dB	

# Specifications HA4404, HA4404A

## Electrical Specifications $V_{DD} = 15V$ , $R_L = 10k\Omega$ , $V_{OS} = 0.8V$ Unless Otherwise Specified (Continued)

PARAMETER		(NOTE 3) TEMPERATURE	HA4404C, HA4404AC			UNITS
			MIN	TYP	MAX	
-3dB Bandwidth	$R_S = 50\Omega$ , $C_L = 11pF$	+25°C		330	-	MHz
	$R_S = 24\Omega$ , $C_L = 19pF$	+25°C	-	290	-	MHz
	$R_S = 15\Omega$ , $C_L = 34pF$	+25°C	-	210	-	MHz
	$R_S = 11\Omega$ , $C_L = 49pF$	+25°C	-	170	-	MHz
70 dB Flat Bandwidth	$R_S = 50\Omega$ , $C_L = 11pF$	+25°C	-	165	-	MHz
	$R_S = 24\Omega$ , $C_L = 19pF$	+25°C	-	130	-	MHz
	$R_S = 15\Omega$ , $C_L = 34pF$	+25°C	-	137	-	MHz
	$R_S = 11\Omega$ , $C_L = 49pF$	+25°C	-	100	-	MHz
Input Resistance		Full	200	400	-	k $\Omega$
Input Capacitance		Full	-	1.5	-	pF
Enabled Output Resistance		Full	-	15	-	$\Omega$
Disabled Output Capacitance ( $V_{DS} = 2.0V$ )	HA4404	Full	-	6.5	-	pF
	HA4404A	Full	-	2.5	-	pF
Differential Gain (4.43MHz, Note 1)		+25°C	-	0.01	0.02	%
Differential Phase (4.43MHz, Note 1)		+25°C	-	0.01	0.02	Degrees
Off Isolation ( $1V_{P-P}$ , 100MHz, $V_{DS} = 2.0V$ , $R_L = 10k\Omega$ )		Full	-	70	-	dB
Crosstalk Rejection ( $1V_{P-P}$ , 30MHz)		Full	-	80	-	dB
Slew Rate ( $1.5V_{P-P}$ , -SR/-SR)	$R_S = 50\Omega$ , $C_L = 11pF$	+25°C	-	1280/1260	-	V/ $\mu$ s
	$R_S = 24\Omega$ , $C_L = 19pF$	+25°C	-	1190/1170	-	V/ $\mu$ s
	$R_S = 15\Omega$ , $C_L = 34pF$	+25°C	-	960/930	-	V/ $\mu$ s
	$R_S = 11\Omega$ , $C_L = 49pF$	+25°C	-	810/790	-	V/ $\mu$ s
Total Harmonic Distortion (10MHz, $R_L = 1k\Omega$ , Note 1)		Full	-	0.01	0.1	%
Disabled Output Resistance ( $V_{DS} = 2.0V$ )		Full	-	12	-	M $\Omega$

### NOTES:

1. This parameter is not tested. The limits are guaranteed based on lab characterization, and reflect lot-to-lot variation.
2. If an input signal is applied before the supplies are powered up, the input current must be limited to these maximum values.
3. Units are 100% tested at +25°C, sample tested at 70°C, guaranteed, but not tested at 0°C.

### AC Test Circuit

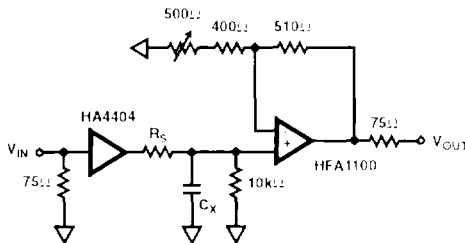

### NOTE:

1.  $C_L = C_X + \text{Test Fixture Capacitance}$

### PC Board Layout

The frequency response of this circuit depends greatly on the care taken in designing the PC board. **The use of low inductance components such as chip resistors and chip capacitors is strongly recommended, while a solid ground plane is a must!**

Attention should be given to decoupling the power supplies. A large value (10 $\mu$ F) tantalum in parallel with a small value (0.1 $\mu$ F) chip capacitor works well in most cases.

Keep input and output traces as short as possible, because trace inductance and capacitance can easily become the performance limiting items.

**Application Information**

**General**

The HA4404 is a 4 x 1 crosspoint switch that is ideal for the matrix element of high performance switchers and routers. This crosspoint's low input capacitance and high input resistance provide excellent video terminations when used with an external 75Ω resistor. Nevertheless, if several HA4404 inputs are connected together, the use of an input buffer should be considered (see Figure 1). This crosspoint contains no feedback or gain setting resistors, so the output is a true high impedance load when the IC is disabled ( $\overline{CS} = 1$ ).

**Ground Connections**

All GND pins are connected to a common point on the die, so any one of them will suffice as the functional GND connection. For the best isolation and crosstalk rejection, however, all GND pins must connect to the GND plane.

**Frequency Response**

Most applications utilizing the HA4404 require a series output resistor,  $R_S$ , to tune the response for the specific load capacitance,  $C_L$ , driven. Bandwidth and slew rate degrade as  $C_L$  increases (as shown in the Electrical Specification table), so give careful consideration to component placement to minimize trace length. In big matrix configurations where  $C_L$  is large, better frequency response is obtained by cascading two levels of crosspoints in the case of multiplexed outputs (see Figure 2), or distributing the load between two drivers if  $C_L$  is due to bussing and subsequent stage input capacitance.

**Control Signals**

$\overline{CS}$  - This is a TTL/CMOS compatible, active low Chip Select input. When driven high,  $\overline{CS}$  forces the output to a true high impedance state and reduces the power dissipation by a factor of 25. The  $\overline{CS}$  input has no on-chip pull-down resistor, so it must be connected to a logic low (recommend GND) if the enable function isn't utilized.

A0, A1 - These are binary coded, TTL/CMOS compatible address inputs that select which one of the four inputs connect to the crosspoint output.

T0-T3 - The Tally outputs are open collector PNP transistors connected to  $V+$ . When  $\overline{CS} = 0$ , the PNP transistor associated with the selected input is enabled and current is delivered to the load. When the crosspoint is disabled, or the channel is unselected, the Tally output(s) present a very high impedance to the external circuitry. Several Tally outputs may be wire OR'd together to generate complex control signals, as shown in the application circuits below. The Tally load may be terminated to GND or to  $V-$  as long as the continuous output current doesn't exceed 3mA (6mA at 50% duty cycle, etc.).

**Switcher/Router Applications**

Figure 1 illustrates one possible implementation of a wide-band, low power, 4 x 4 switcher/router utilizing the HA4404 for the switch matrix. A 4 x 4 switcher/router allows any of the four outputs to be driven by any one of the four inputs (e.g. each of the four inputs may connect to a different output, or an input may connect to multiple outputs). This application utilizes the HA4600 (video buffer with output disable)

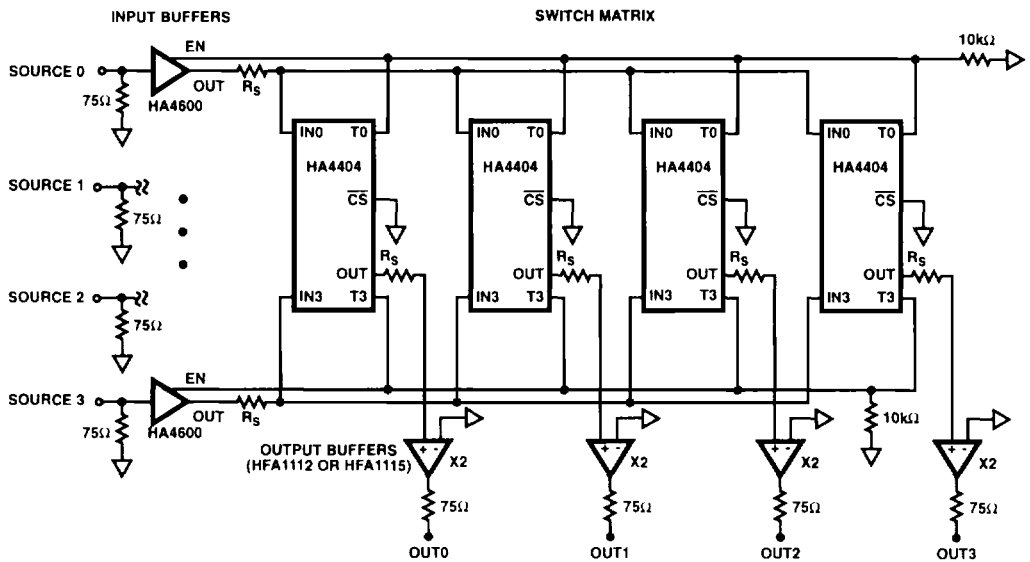

FIGURE 1. 4 X 4 SWITCHER/ROUTER APPLICATION

# HA4404, HA4404A

for the input buffer, the HA4404 as the switch matrix, and the HFA1112 (programmable gain buffer) as the gain of two output driver. Figure 2 details a 16 x 1 switcher (basically a 16:1 mux) which uses the HA4201 (1 x 1 crosspoint) and the HA4404 in a cascaded stage configuration to minimize capacitive loading at each output node, thus increasing system bandwidth.

## Power Up Considerations

No signals should be applied to the analog or digital inputs before the power supplies are activated. Latch-up may occur if the inputs are driven at the time of power up. To prevent latch-up, the input currents during power up must not exceed the values listed in the Absolute Maximum Ratings.

## Harris' Crosspoint Family

Harris offers a variety of 4 x 1 and 1 x 1 crosspoint switches. In addition to the HA4404, the 4 x 1 family includes the HA4314 and HA4344. The HA4314 is a basic 14 lead device without Tally outputs. The HA4344 is a 16 lead crosspoint with synchronized control lines (A0, A1,  $\overline{CS}$ ). With synchronization, the control information for the next channel switch can be loaded into the crosspoint without affecting the current state. On a subsequent clock edge the stored control state effects the desired channel switch.

The 1 x 1 family is comprised of the HA4201 and HA4600. They are essentially similar devices, but the HA4201 includes a Tally output. The 1 x 1's are useful as high performance video input buffers, or in a switch matrix requiring very high off isolation.

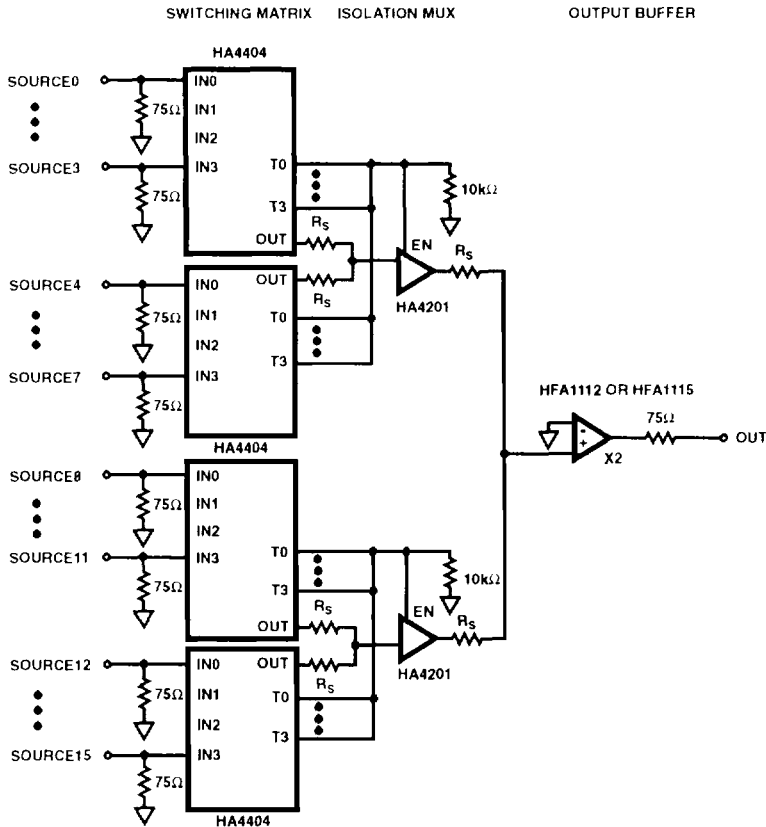

FIGURE 2. 16 X 1 SWITCHER APPLICATION

# HA4404, HA4404A

## Die Characteristics

### DIE DIMENSIONS:

65 x 118 x 19 ±1mil  
1640µm x 3000µm x 483µm ±25.4µm

### METALLIZATION:

Type: Metal 1: AlCu (1%)TiW      Type: Metal 2: AlCu (1%)  
Thickness: Metal 1: 6kÅ ±0.8kÅ      Thickness: Metal 2: 16kÅ ±1.1kÅ

### GLASSIVATION:

Type: Nitride  
Thickness: 4kÅ ±0.5kÅ

TRANSISTOR COUNT: 200

SUBSTRATE POTENTIAL (Powered Up): V-

## Metallization Mask Layout

HA4404, HA4404A

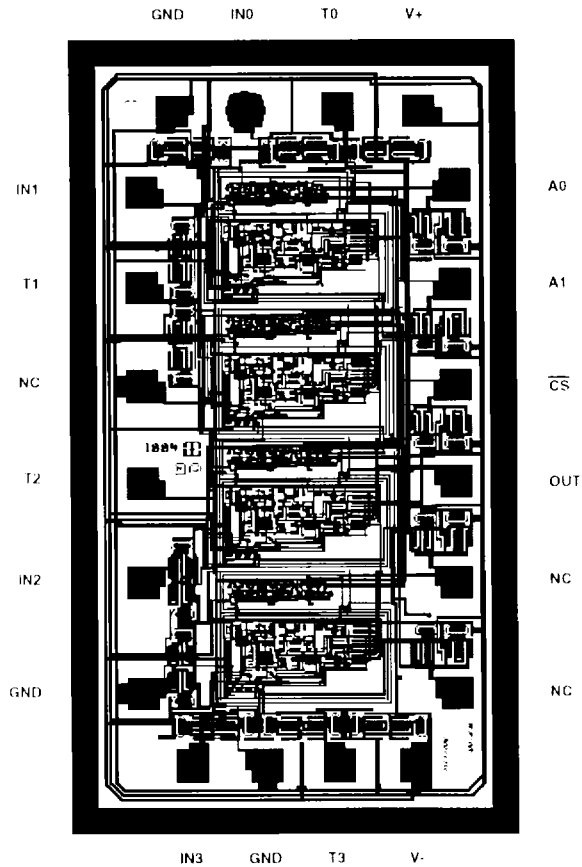

Typical Performance Curves  $V_{SUPPLY} = \pm 5V$ ,  $T_A = +25^\circ C$ ,  $R_L = 10k\Omega$ , Unless Otherwise Specified

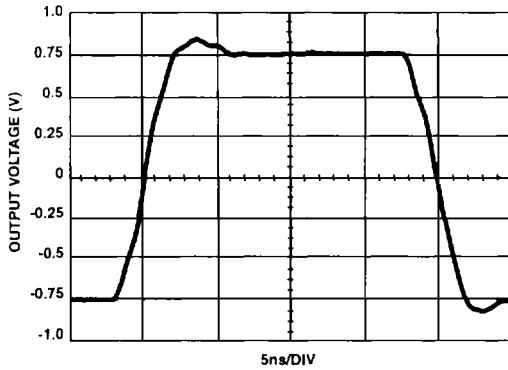

FIGURE 3. LARGE SIGNAL PULSE RESPONSE

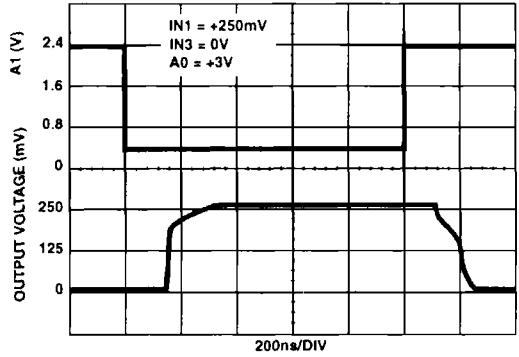

FIGURE 4. CHANNEL-TO-CHANNEL SWITCHING RESPONSE

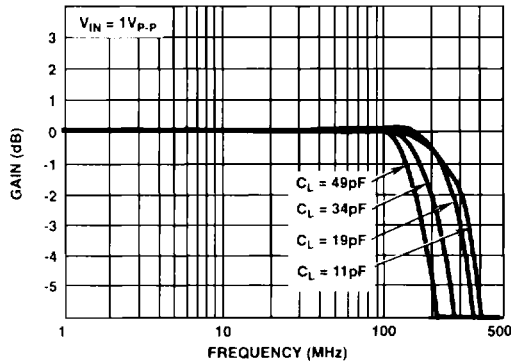

FIGURE 5. FREQUENCY RESPONSE

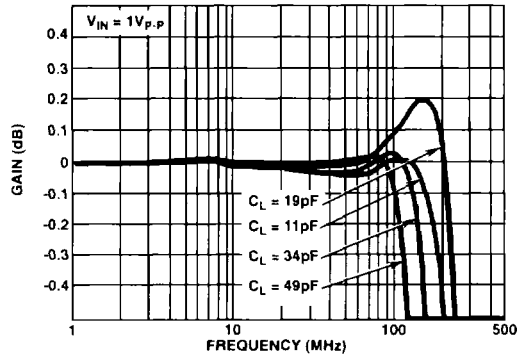

FIGURE 6. GAIN FLATNESS

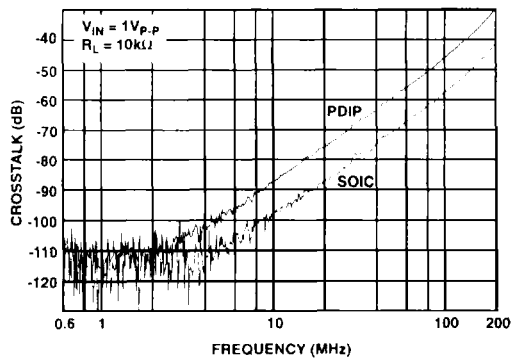

FIGURE 7. ALL HOSTILE CROSSTALK REJECTION

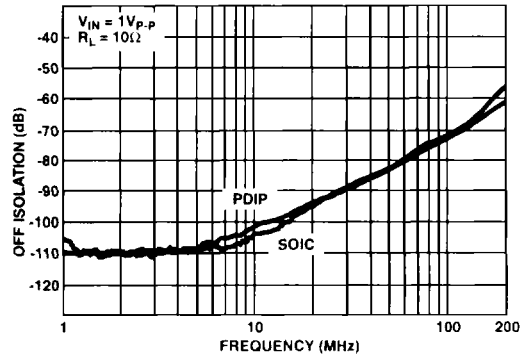

FIGURE 8. ALL HOSTILE OFF ISOLATION

Typical Performance Curves  $V_{SUPPLY} = \pm 5V$ ,  $T_A = +25^\circ C$ ,  $R_L = 10k\Omega$ , Unless Otherwise Specified (Continued)

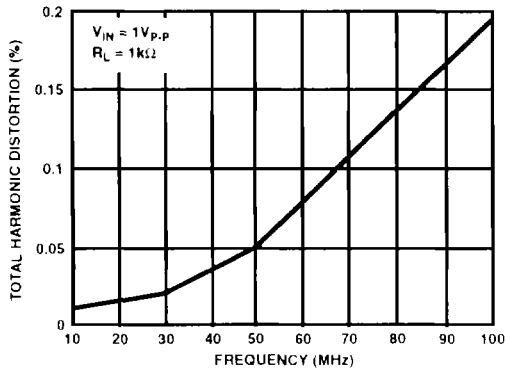

FIGURE 9. TOTAL HARMONIC DISTORTION vs FREQUENCY

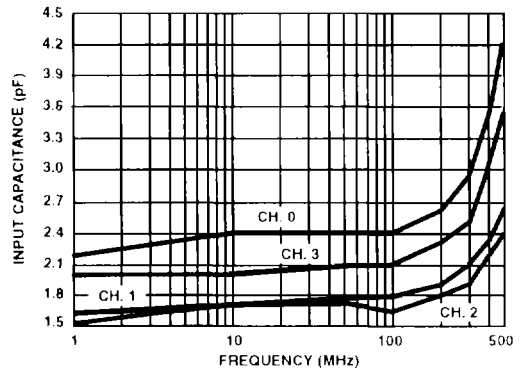

FIGURE 10. INPUT CAPACITANCE vs FREQUENCY