

CC030-Series Power Modules; dc-dc Converters: 18 Vdc to 36 Vdc Inputs, 30 W



The CC030-Series Power Modules use advanced, surface-mount technology and deliver high-quality, compact, dc-dc conversion at an economical price.

Options

- Choice of remote on/off logic configuration
- Case ground pin
- Short pins: 2.79 mm \pm 0.25 mm (0.110 in. \pm 0.010 in.)

Description

The CC030-Series Power Modules are dc-dc converters that operate over an input voltage range of 18 Vdc to 36 Vdc and provide precisely regulated outputs. The outputs are isolated from the inputs, allowing versatile polarity configurations and grounding connections. The modules have maximum power ratings of 30 W at a typical full-load efficiency of 81%.

The power modules feature remote on/off, output sense (both negative and positive leads), and output voltage adjustment from 90% to 110% of the nominal output voltage. For diskdrive applications, the CC030B Power Module provides a motor-start surge current of 3 A. The modules are PC board-mountable and encapsulated in metal cases. The modules are rated to full load at 100 °C case temperature.

* *UL* is a registered trademark of Underwriters Laboratories, Inc.

† *CSA* is a registered trademark of Canadian Standards Association.

‡ *VDE* is a trademark of Verband Deutscher Elektrotechniker e.V.

Features

- Small size: 61.0 mm x 71.1 mm x 12.7 mm (2.40 in. x 2.80 in. x 0.50 in.)
- Low output noise
- Constant frequency
- Industry-standard pinout
- Metal case
- 2:1 input voltage range
- High efficiency: 81% typical
- Positive remote on/off logic
- Remote sense
- Adjustable output voltage: 90% to 110% of $V_{O, nom}$
- *UL** 1950 Recognized, *CSA*† C22.2 No. 950-95 Certified, *VDE*‡ 0805 (EN60950, IEC950) Licensed
- Within FCC Class A Radiated Limits

Applications

- Distributed power architectures
- Communication equipment
- Computer equipment

Absolute Maximum Ratings

Stresses in excess of the absolute maximum ratings can cause permanent damage to the device. These are absolute stress ratings only. Functional operation of the device is not implied at these or any other conditions in excess of those given in the operations sections of the data sheet. Exposure to absolute maximum ratings for extended periods can adversely affect device reliability.

Parameter	Symbol	Min	Max	Unit
Input Voltage (continuous)	V_I	—	50	Vdc
Operating Case Temperature (See Thermal Considerations section.)	T_C	-40	100	°C
Storage Temperature	T_{stg}	-40	110	°C
I/O Isolation Voltage: Continuous	—	—	500	Vdc
Transient (1 min)	—	—	800	V

Electrical Specifications

Unless otherwise indicated, specifications apply over all operating input voltage, resistive load, and temperature conditions.

Table 1. Input Specifications

Parameter	Symbol	Min	Typ	Max	Unit
Operating Input Voltage	V_I	18	24	36	Vdc
Maximum Input Current ($V_I = 0$ V to 75 V; $I_O = I_{O, max}$; see Figure 1.)	$I_{I, max}$	—	—	3.0	A
Inrush Transient	i^2t	—	—	0.2	A ² s
Input Reflected-Ripple Current, Peak-to-Peak (0.5 Hz to 20 MHz, 12 source impedance; see Figure 14 and Design Considerations.)	I_r	—	30	—	mAp-p
Input Ripple Rejection (120 Hz)	—	—	60	—	dB

Fusing Considerations

CAUTION: This power module is not internally fused. An input line fuse must always be used.

This encapsulated power module can be used in a wide variety of applications, ranging from simple stand-alone operation to an integrated part of a sophisticated power architecture. To preserve maximum flexibility, internal fusing is not included; however, to achieve maximum safety and system protection, always use an input line fuse. The safety agencies require a normal-blow fuse with a maximum rating of 5 A in series with the input (see Safety Considerations section). Based on the information provided in this data sheet on inrush energy and maximum dc input current, the same type of fuse with a lower rating can be used. Refer to the fuse manufacturer's data for further information.

Electrical Specifications (continued)

Table 2. Output Specifications

Parameter	Device	Symbol	Min	Typ	Max	Unit
Output Voltage Set Point ($V_I = 24\text{ V}$; $I_O = I_{O, \text{max}}$; $T_C = 25\text{ }^\circ\text{C}$)	CC030A	$V_{O, \text{set}}$	4.90	5.0	5.10	Vdc
	CC030B	$V_{O, \text{set}}$	11.76	12.0	12.24	Vdc
	CC030C	$V_{O, \text{set}}$	14.70	15.0	15.30	Vdc
Output Voltage (Over all operating input voltage, resistive load, and temperature conditions until end of life; see Figure 15.)	CC030A	V_O	4.80	—	5.20	Vdc
	CC030B	V_O	11.52	—	12.48	Vdc
	CC030C	V_O	14.40	—	15.60	Vdc
Output Regulation: Line ($V_I = 18\text{ V}$ to 36 V) Load ($I_O = I_{O, \text{min}}$ to $I_{O, \text{max}}$) Temperature ($T_C = -40\text{ }^\circ\text{C}$ to $+100\text{ }^\circ\text{C}$)	All	—	—	0.01	0.1	% V_O
	All	—	—	0.05	0.1	% V_O
	All	—	—	0.5	1.5	% V_O
Output Ripple and Noise Voltage: RMS Peak-to-peak (5 Hz to 20 MHz)	CC030A	—	—	—	20	mVrms
	CC030B, C	—	—	—	25	mVrms
	CC030A	—	—	—	150	mVp-p
	CC030B, C	—	—	—	200	mVp-p
External Load Capacitance	All	—	0	—	4700	μF
Output Current (At $I_O < I_{O, \text{min}}$, the modules may exceed output ripple specifications.)	CC030A	I_O	0.6	—	6.0	A
	CC030B	I_O	0.3	—	2.5	A
	CC030B	$I_{O, \text{trans}}$	—	—	3.0	A
	CC030C	I_O	0.2	—	2.0	A
Output Current-limit Inception ($V_O = 90\%$ of $V_{O, \text{nom}}$)	CC030A	I_O	—	6.9	—	A
	CC030B	I_O	—	3.6	—	A
	CC030C	I_O	—	2.5	—	A
Output Short-circuit Current ($V_O = 250\text{ mV}$)	CC030A	—	—	8.0	—	A
	CC030B	—	—	4.0	—	A
	CC030C	—	—	3.0	—	A
Efficiency ($V_I = 24\text{ V}$; $I_O = I_{O, \text{max}}$; $T_C = 25\text{ }^\circ\text{C}$; see Figures 8—10 and 15.)	CC030A	η	78	81	—	%
	CC030B, C	η	80	81	—	%
Switching Frequency	All	—	—	250	—	kHz
Dynamic Response ($\dot{I}_O/\dot{I}_T = 1\text{ A}/10\text{ }\mu\text{s}$, $V_I = 24\text{ V}$, $T_C = 25\text{ }^\circ\text{C}$): Load Change from $I_O = 50\%$ to 75% of $I_{O, \text{max}}$ (See Figure 11.): Peak Deviation Settling Time ($V_O < 10\%$ peak deviation) Load Change from $I_O = 50\%$ to 25% of $I_{O, \text{max}}$ (See Figure 12.): Peak Deviation Settling Time ($V_O < 10\%$ of peak deviation)	All	—	—	2	—	% $V_{O, \text{set}}$
	All	—	—	0.5	—	ms
	All	—	—	2	—	% $V_{O, \text{set}}$
	All	—	—	0.5	—	ms

Electrical Specifications (continued)

Table 3. Isolation Specifications

Parameter	Min	Typ	Max	Unit
Isolation Capacitance	—	0.02	—	μF
Isolation Resistance	10	—	—	M ³ / ₄

General Specifications

Parameter	Min	Typ	Max	Unit
Calculated MTBF (I _o = 80% of I _{o, max} ; T _c = 40 °C)	3,900,000			hours
Weight	—	—	113 (4.0)	g (oz.)

Feature Specifications

Unless otherwise indicated, specifications apply over all operating input voltage, resistive load, and temperature conditions. See Feature Descriptions and Design Considerations for further information.

Parameter	Device	Symbol	Min	Typ	Max	Unit
Remote On/Off (V _i = 18 V to 36 V; open collector or equivalent compatible; signal referenced to V _i (-) terminal. See Figure 16 and Feature Descriptions.): Logic Low—Module Off Logic High—Module On Module Specifications: On/Off Current—Logic Low On/Off Voltage: Logic Low Logic High (I _{on/off} = 0) Open-collector Switch Specifications: Leakage Current During Logic High (V _{on/off} = 10 V) Output Low Voltage During Logic Low (I _{on/off} = 1 mA) Turn-on Time (@ 80% of I _{o, max} ; T _A = 25 °C; V _o within ±1% of steady state) Output Voltage Overshoot (See Figure 13.)	All	I _{on/off}	—	—	1.0	mA
	All	V _{on/off}	-0.7	—	1.2	V
	All	V _{on/off}	—	—	6	V
	All	I _{on/off}	—	—	50	μA
	All	V _{on/off}	—	—	1.2	V
	All	—	—	—	5	ms
	All	—	—	0	5	%
Output Voltage Sense Range	All	—	—	—	0.5	V
Output Voltage Set Point Adjustment Range (See Feature Descriptions.)	All	V _{trim}	90	—	110	%V _{o, nom}
Output Overvoltage Protection (clamp)	CC030A	V _{o, clamp}	5.6	—	7.0	V
	CC030B	V _{o, clamp}	13.0	—	16.0	V
	CC030C	V _{o, clamp}	17.0	—	20.0	V

Characteristic Curves

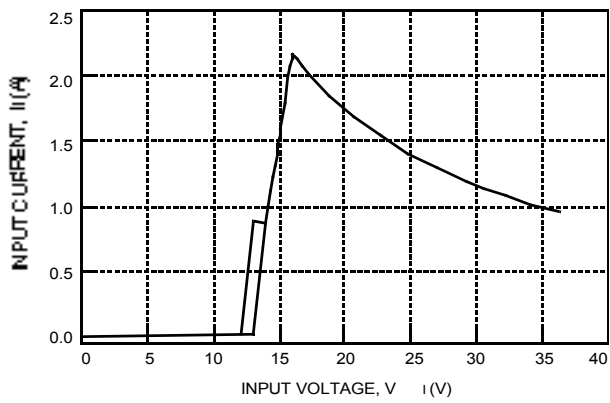

8-724(C)

Figure 1. CC030-Series Typical Input Characteristic

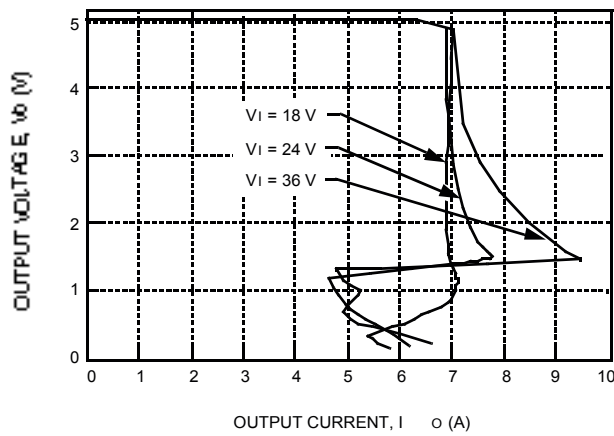

8-721(C)

Figure 2. CC030A Typical Output Characteristics

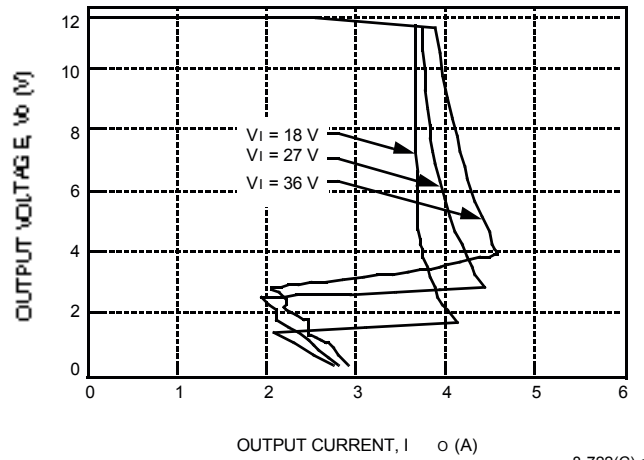

8-722(C).a

Figure 3. CC030B Typical Output Characteristics

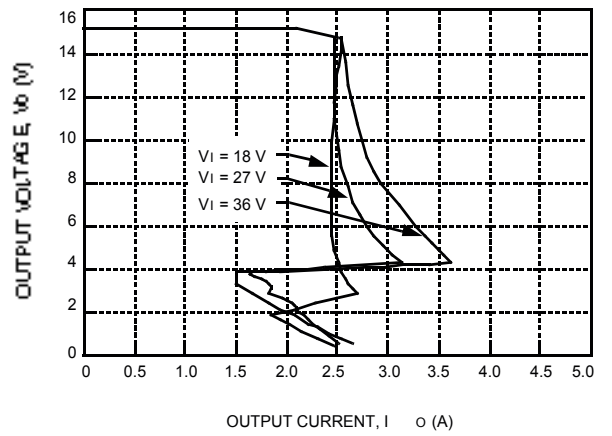

8-723(C).a

Figure 4. CC030C Typical Output Characteristics

Characteristic Curves (continued)

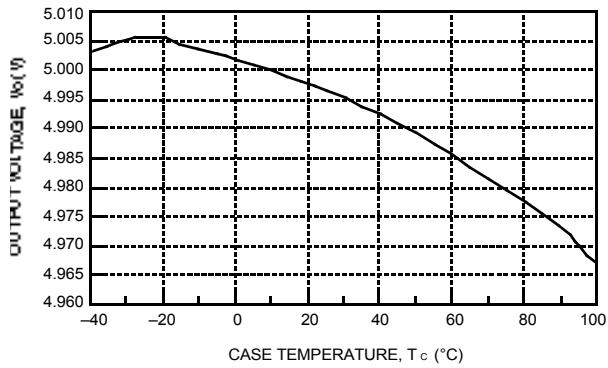

8-852(C)

Figure 5. CC030A Typical Output Voltage Variation over Ambient Temperature Range

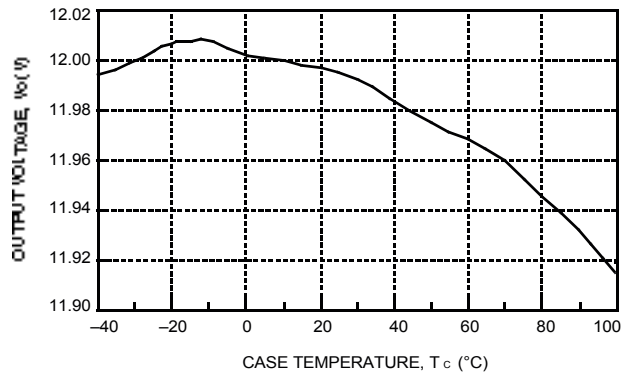

8-853(C)

Figure 6. CC030B Typical Output Voltage Variation over Ambient Temperature Range

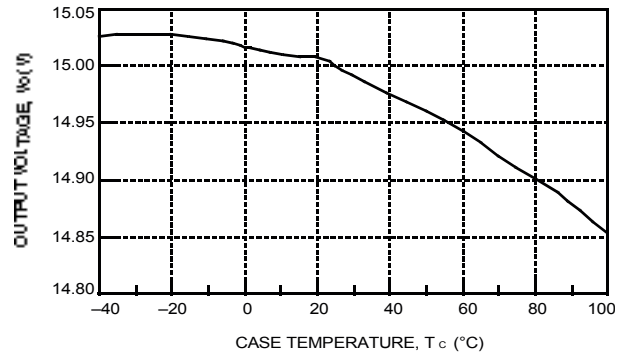

8-854(C)

Figure 7. CC030C Typical Output Voltage Variation over Ambient Temperature Range

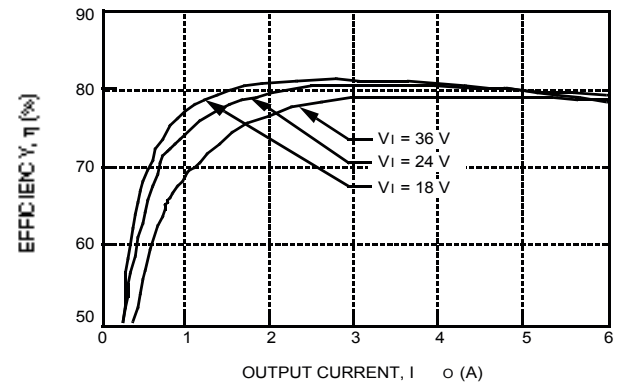

8-727(C).a

Figure 8. CC030A Typical Converter Efficiency vs. Output Current

Characteristic Curves (continued)

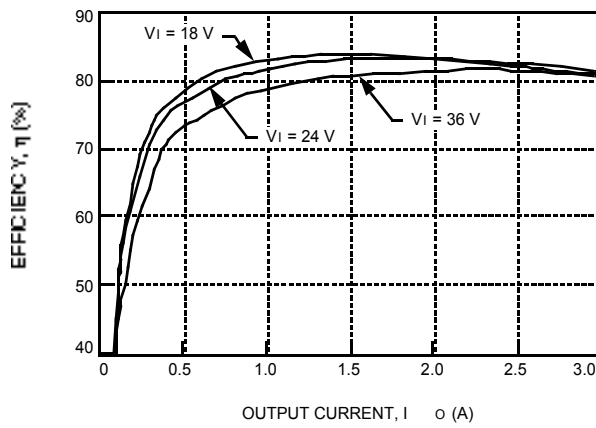

Figure 9. CC030B Typical Converter Efficiency vs. Output Current

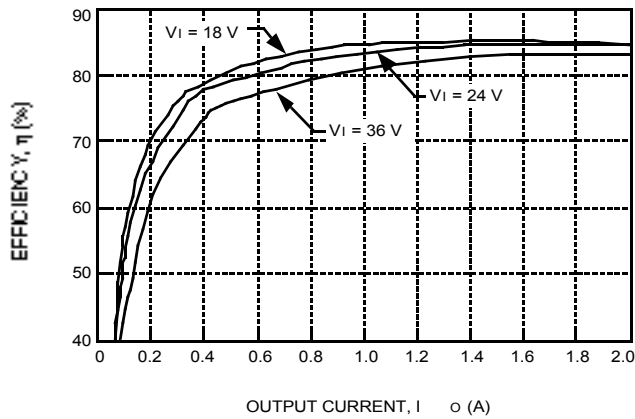

Figure 10. CC030C Typical Converter Efficiency vs. Output Current

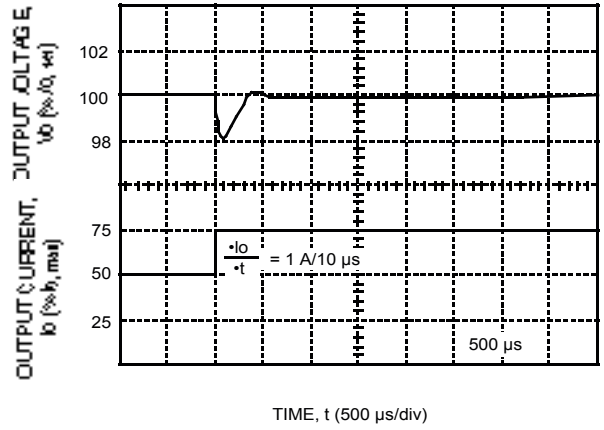

Figure 11. Typical Output Voltage for a Step Load Change from 50% to 75%

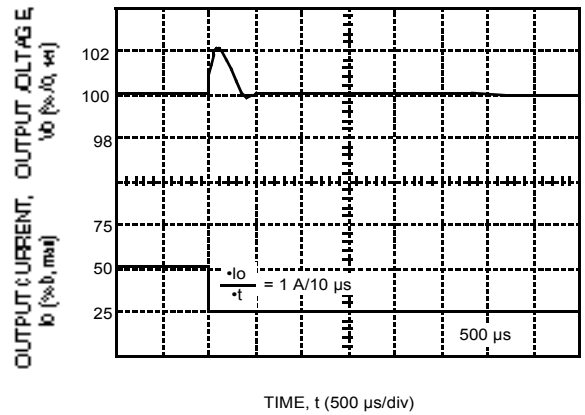
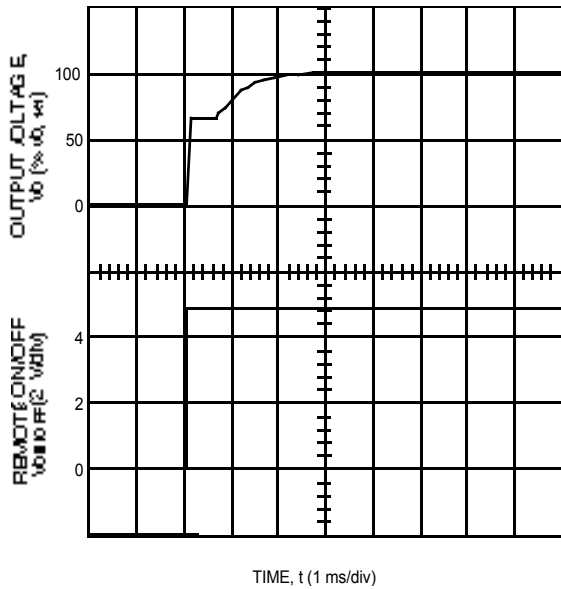

Figure 12. Typical Output Voltage for a Step Load Change from 50% to 25%

Characteristic Curves (continued)



8-2825(C)

Figure 13. Typical Output Voltage Start-Up when Signal Applied to Remote On/Off

Test Configurations

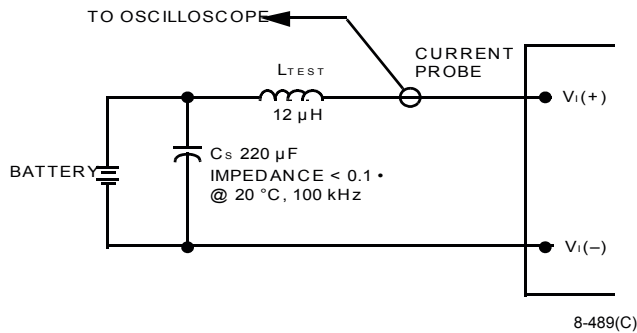

8-489(C)

Note: Input reflected-ripple current is measured with a simulated source impedance of 12 μ H. Capacitor C_s offsets possible battery impedance. Current is measured at the input of the module.

Figure 14. Input Reflected-Ripple Test Setup

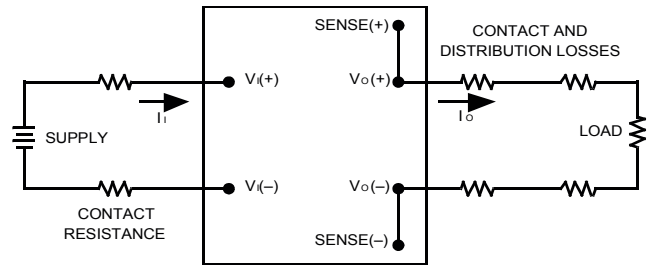

8-749(C)

Note: All measurements are taken at the module terminals. When socketing, place Kelvin connections at module terminals to avoid measurement errors due to socket contact resistance.

$$\eta = \left(\frac{[V_o(+)-V_o(-)]I_o}{[V_i(+)-V_i(-)]I_i} \right) \times 100 \quad \%$$

Figure 15. Output Voltage and Efficiency Measurement Test Setup

Design Considerations

Grounding Considerations

For modules without the isolated case pin option, the case is internally connected to the $V_i(-)$ pin. For modules with the isolated case pin option, device code suffix "7," the case is not connected internally allowing the user flexibility in grounding.

Design Considerations (continued)

Input Source Impedance

The power module should be connected to a low ac-impedance input source. Source inductance greater than 12 μH can affect the stability of the power module. A 33 μF electrolytic capacitor (ESR < 0.7 $\frac{3}{4}$ at 100 kHz) mounted close to the power module helps ensure stability of the unit. For other highly inductive source impedances, consult the factory for further application guidelines. (See Figure 14.)

Safety Considerations

For safety-agency approval of the system in which the power module is used, the power module must be installed in compliance with the spacing and separation requirements of the end-use safety agency standard, i.e., UL 1950, CSA C22.2 No. 950-95, and VDE 0805 (EN60950, IEC950).

For the converter output to be considered meeting the requirements of safety extra-low voltage (SELV), the input must meet SELV requirements.

The power module has extra-low voltage (ELV) outputs when all inputs are ELV.

The input to these units is to be provided with a maximum 5 A normal-blow fuse in the ungrounded lead.

Feature Descriptions

Overcurrent Protection

To provide protection in a fault (output overload) condition, the unit is equipped with internal current-limiting circuitry and can endure current limiting for an unlimited duration. At the point of current-limit inception, the unit shifts from voltage control to current control. If the output voltage is pulled very low during a severe fault, the current-limit circuit can exhibit either foldback or tailout characteristics (output-current decrease or increase). The unit operates normally once the output current is brought back into its specified range.

Remote On/Off

To turn the power module on and off, the user must supply a switch to control the voltage between the on/off terminal and the $V_{\text{I}(-)}$ terminal ($V_{\text{on/off}}$). The switch can be an open collector or equivalent (see Figure 16). A logic low is $V_{\text{on/off}} = -0.7 \text{ V}$ to 1.2 V, during which the module is off. The maximum $I_{\text{on/off}}$ during a logic low is 1 mA. The switch should maintain a logic-low voltage while sinking 1 mA.

During a logic high, the maximum $V_{\text{on/off}}$ generated by the power module is 6 V. The maximum allowable leakage current of the switch at $V_{\text{on/off}} = 6 \text{ V}$ is 50 μA .

The module has internal capacitance to reduce noise at the ON/OFF pin. Additional capacitance is not generally needed and may degrade the start-up characteristics of the module.

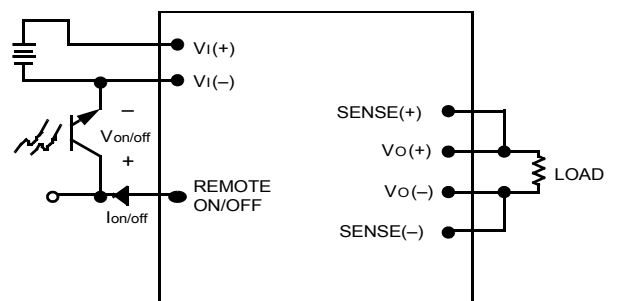

8-720(C).i

Figure 16. Remote On/Off Implementation

Remote Sense

Remote sense minimizes the effects of distribution losses by regulating the voltage at the remote-sense connections. The voltage between the remote-sense pins and the output terminals must not exceed the output voltage sense range given in the Feature Specifications table, for example, for the CC030Bs:

$$[V_{\text{O}(+) - V_{\text{O}(-)}] - [\text{SENSE}(+) - \text{SENSE}(-)] \leq 0.5 \text{ V}$$

The voltage between the $V_{\text{O}(+)}$ and $V_{\text{O}(-)}$ terminals must not exceed 13.2 V. This limit includes any increase in voltage due to remote-sense compensation, set-point adjustment, and trim (see Figure 17).

Feature Descriptions (continued)

Remote Sense (continued)

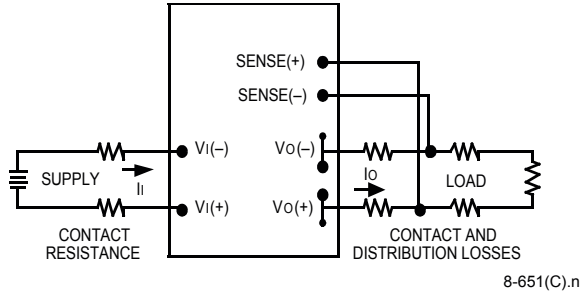

Figure 17. Effective Circuit Configuration for Single-Module Remote-Sense Operation

The CC030-Series Power Modules have a fixed current-limit set point. Therefore, as the output voltage is adjusted down, the available output power is reduced. In addition, the minimum output current is a function of the output voltage. As the output voltage is adjusted down, the minimum required output current can increase.

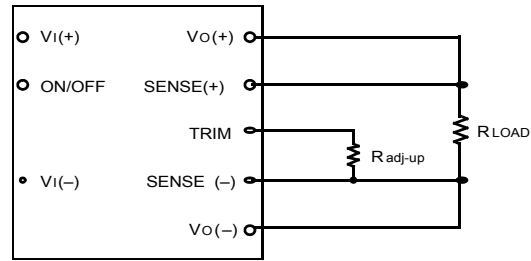

Figure 18. Circuit Configuration to Increase Output Voltage

Output Voltage Adjustment

Output voltage adjustment allows the user to increase or decrease the output voltage set point of a module. This is accomplished by connecting an external resistor between the TRIM pin and either the SENSE(+) or SENSE(-) pins (see Figures 18 and 19). With an external resistor between the TRIM and SENSE(-) pins (R_{adj-up}), the output voltage set point ($V_{O, adj}$) increases.

$$R_{adj-up} = \left(\frac{2.5 \times R_1}{V_{O, adj} - V_{O, nom}} \right) k\Omega$$

The value of the internal resistor R_1 is shown in Table 4.

Table 4. Internal Resistor Values

BMPM Code	R_1
CC030A	16.940
CC030B	15.732
CC030C	16.670

With an external resistor connected between the TRIM and SENSE(+) pins ($R_{adj-down}$), the output voltage set point ($V_{O, adj}$) decreases.

$$R_{adj-down} = \left(\frac{(V_{O, adj} - 2.5) \times R_1}{V_{O, nom} - V_{O, adj}} \right) k\Omega$$

The combination of the output voltage adjustment range and the output voltage sense range given in the Feature Specifications table cannot exceed 110% of the nominal output voltage between the $V_{o(+)}$ and $V_{o(-)}$ terminals.

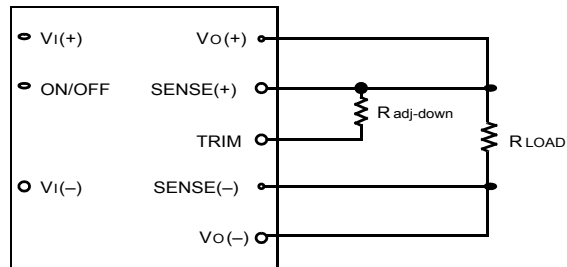

Figure 19. Circuit Configuration to Decrease Output Voltage

Output Overvoltage Protection

The output overvoltage clamp consists of control circuitry, which is independent of the primary regulation loop that monitors the voltage on the output terminals. The control loop of the clamp has a higher voltage set point than the primary loop (see Feature Specifications table). This provides a redundant voltage-control that reduces the risk of output overvoltage.

Thermal Considerations

The CC030-Series Power Modules are designed to operate in a variety of thermal environments. As with any electronic component, sufficient cooling must be provided to help ensure reliable operation. Heat-dissipating components inside the module are thermally coupled to the case to enable heat removal by conduction, convection, and radiation to the surrounding environment.

The thermal data presented is based on measurements taken in a wind tunnel. The test setup shown in Figure 20 was used to collect data for Figures 24 and 25.

The graphs in Figures 21 through 23 provide general guidelines for use. Actual performance can vary depending on the particular application environment. The maximum case temperature of 100 °C must not be exceeded.

Basic Thermal Performance

The CC030-Series Power Modules are constructed with a specially designed, heat spreading enclosures. As a result, full load operation in natural convection at 50 °C can be achieved without the use of an external heat sink.

Higher ambient temperatures can be sustained by increasing the airflow or by adding a heat sink. As stated, this data is based on a maximum case temperature of 100 °C and measured in the test configuration shown in Figure 20.

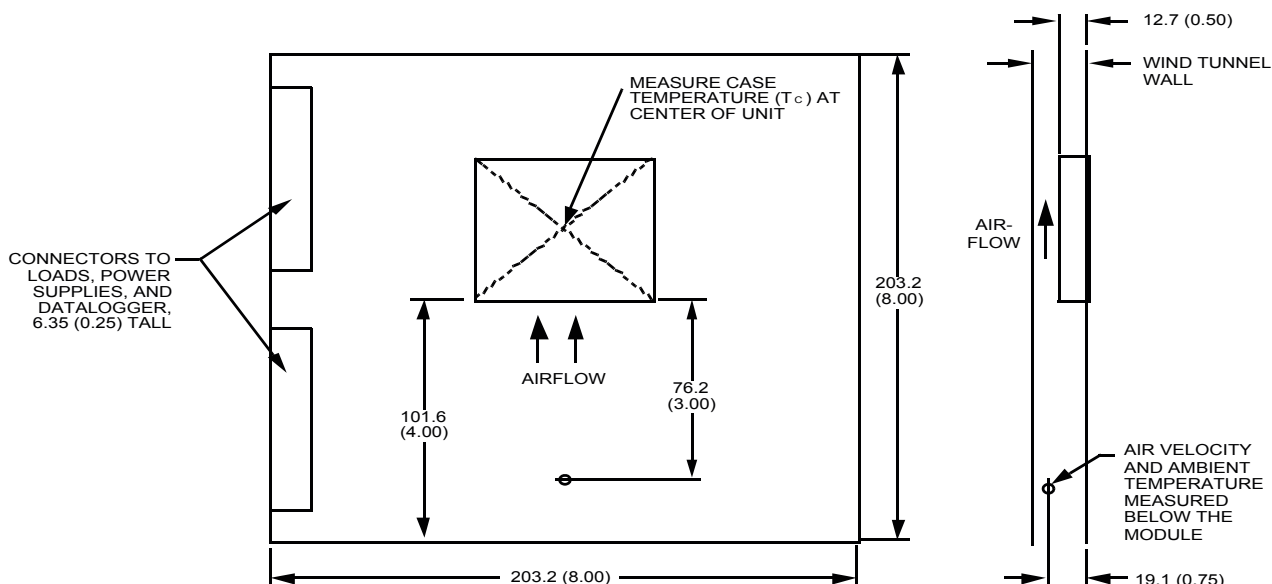

8-1046(C)

Figure 20. Thermal Test Setup

Thermal Considerations (continued)

Forced Convection Cooling

To determine the necessary airflow, determine the power dissipated by the unit for the particular application. Figures 21 through 23 show typical power dissipation for these power modules over a range of output currents. With the known power dissipation and a given local ambient temperature, the appropriate airflow can be chosen from the derating curves in Figure 24. For example, if the unit dissipates 6.2 W, the minimum airflow in a 80 °C environment is 1.0 ms⁻¹ (200 ft./min).

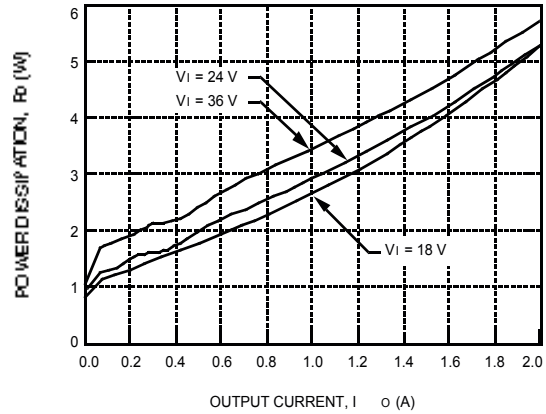

8-1212(C).a

Figure 23. CC030C Power Dissipation vs. Output Current

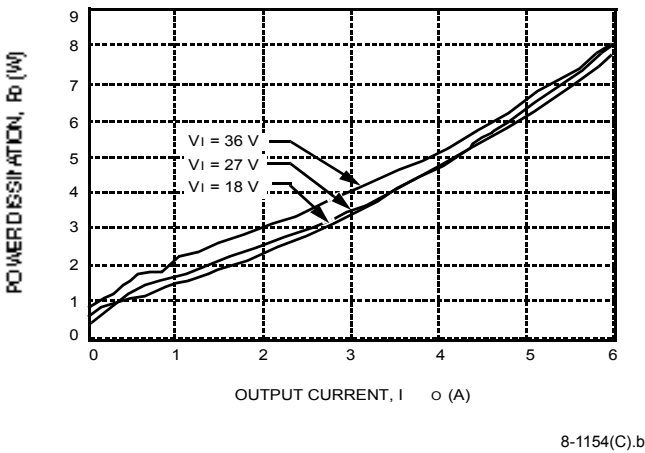

8-1154(C).b

Figure 21. CC030A Power Dissipation vs. Output Current

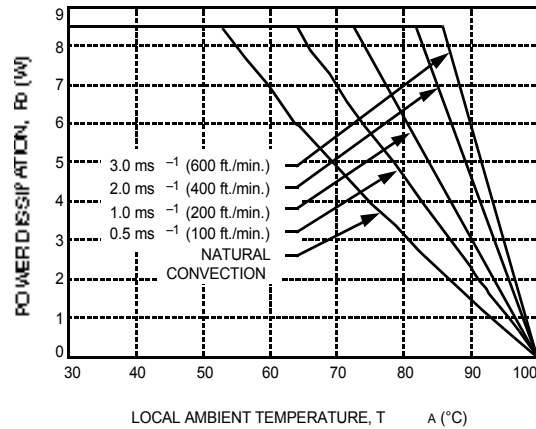

8-1155(C)

Figure 24. Forced Convection Power Derating with No Heat Sink; Either Orientation

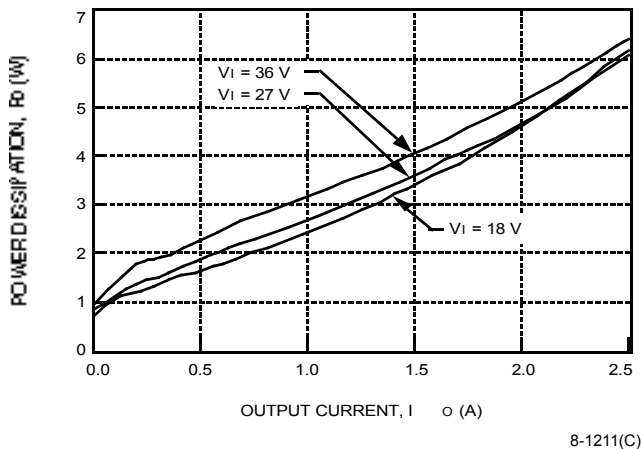

8-1211(C)

Figure 22. CC030B Power Dissipation vs. Output Current

Thermal Considerations (continued)

Heat Sink Selection

Several heat sinks are available for these modules. The case includes through threaded mounting holes allowing attachment of heat sinks or cold plates from either side of the module. The mounting torque must not exceed 0.56 N-m (5 in.-lb).

Figure 25 shows the case-to-ambient thermal resistance, θ ($^{\circ}\text{C}/\text{W}$), for these modules. These curves can be used to predict which heat sink will be needed for a particular environment. For example, if the unit dissipates 7.1 W of heat in an 80 $^{\circ}\text{C}$ environment with an airflow of 0.5 ms^{-1} (100 ft./min.), the minimum heat sink required can be determined as follows:

$$\theta \leq (T_{c, \max} - T_A) / P_D$$

where:

- θ = module's total thermal resistance
- $T_{c, \max}$ = case temperature (See Figure 20.)
- T_A = inlet ambient temperature (See Figure 20.)
- P_D = power dissipation

$$\theta \leq (100 - 80) / 7.1$$

$$\theta \leq 2.8 \text{ } ^{\circ}\text{C}/\text{W}$$

From Figure 25, the 1/2 in. high heat sink or greater is required.

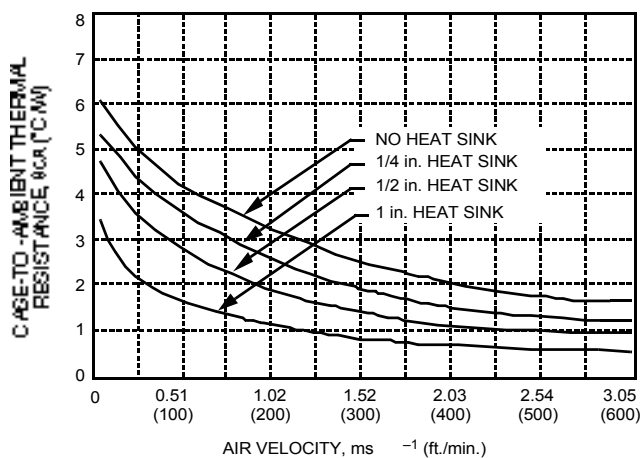

8-1157(C).c

Figure 25. Case-to-Ambient Thermal Resistance vs. Air Velocity Curves; Either Orientation

Although the previous example uses 100 $^{\circ}\text{C}$ as the maximum case temperature, for extremely high-reliability applications, one can use a lower temperature for $T_{c, \max}$.

It is important to point out that the thermal resistances shown in Figure 25 are for heat transfer from the sides and bottom of the module as well as the top side with the attached heat sink; therefore, the case-to-ambient thermal resistances shown will generally be lower than the resistance of the heat sink by itself. The data in Figure 25 was taken with a thermally conductive dry pad between the case and the heat sink to minimize contact resistance (typically 0.1 $^{\circ}\text{C}/\text{W}$ to 0.3 $^{\circ}\text{C}/\text{W}$).

For a more detailed explanation of thermal energy management for this series of power modules as well as more details on available heat sinks, please request the following technical note: Thermal Energy Management CC-, CW-, DC-, and DW-Series 25 W to 30 W Board-Mounted Power Modules (TN97-015EPS).

Layout Considerations

Copper paths must not be routed beneath the power module standoffs.

Outline Diagram

Dimensions are in millimeters and (inches).

Tolerances: $x.x \pm 0.5$ mm (0.02 in.), $x.xx \pm 0.25$ mm (0.010 in.)

Note: For standard modules, $V_I(-)$ is internally connected to the case.

Top View

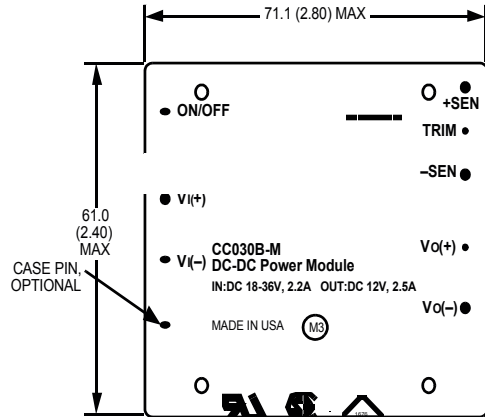

Side View

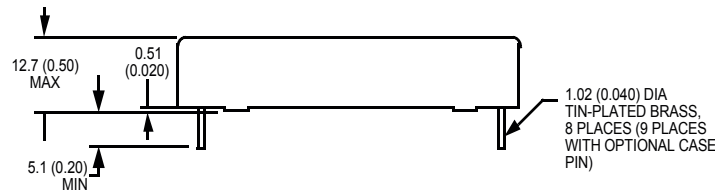

Bottom View

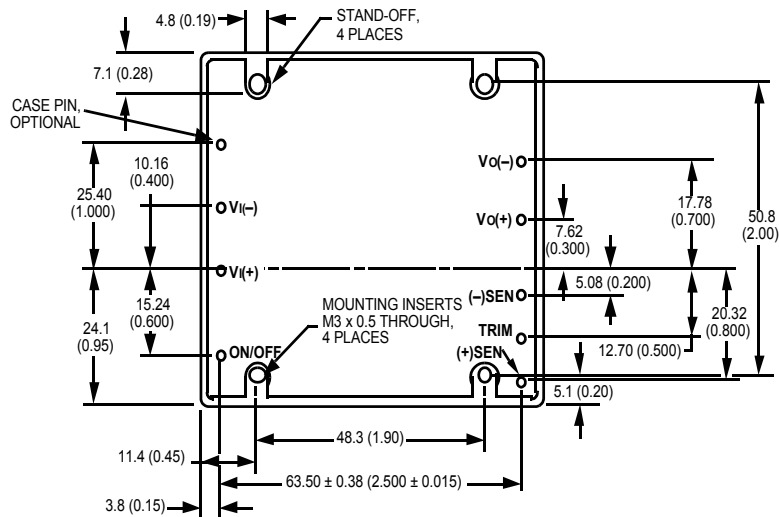

8-1214(C).a

Recommended Hole Pattern

Component-side footprint.

Dimensions are in millimeters and (inches).

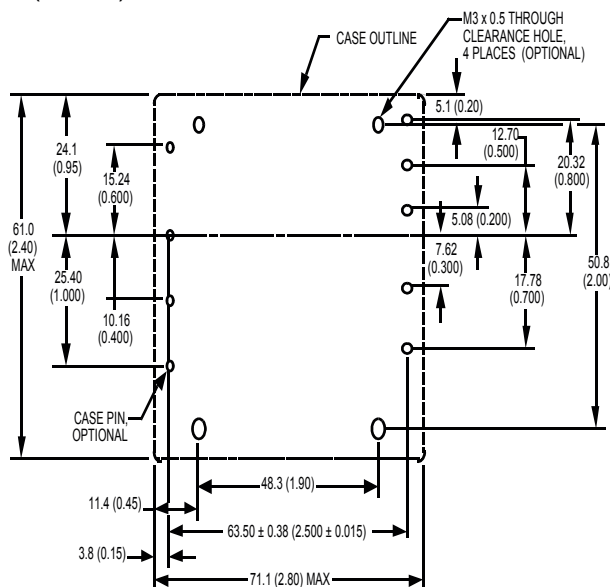

8-1214(C).a

Ordering Information

For assistance with ordering options, contact your Lineage Power Account Manager or Field Application Engineer.

Table 5. Device Codes

Input Voltage	Output Voltage	Output Power	Device Code	Comcode
24 V	5 V	30 W	CC030A-M	107587172
24 V	12 V	30 W	CC030B-M	107587180
24 V	15 V	30 W	CC030C-M	107587198

Table 6. Device Options

Option	Comcode
Short pins: 2.79 mm ± 0.25 mm (0.110 in. ± 0.010 in.)	8
Case ground pin	7
Negative Remote On/Off	1



LINEAGE POWER

World Wide Headquarters

Lineage Power Corporation

3000 Skyline Drive, Mesquite, TX 75149, USA

+1-800-526-7819

(Outside U.S.A.: **+1-972-284-2626**)

www.lineagepower.com

e-mail: techsupport1@lineagepower.com

Asia-Pacific Headquarters

Tel: +65 6416 4283

Europe, Middle-East and Africa Headquarters

Tel: +49 89 6089 286

India Headquarters

Tel: +91 80 28411633

Lineage Power reserves the right to make changes to the product(s) or information contained herein without notice. No liability is assumed as a result of their use or application. No rights under any patent accompany the sale of any such product(s) or information.

© 2008 Lineage Power Corporation, (Mesquite, Texas) All International Rights Reserved.

March 2008

DS98-225EPS (Replaces DS98-224EPS)