

0.5mm Pitch  
SERIES

# 6244

0.5mmピッチ NON-ZIF ストレート SMT 片面接点  
0.5mmPitch LIF Vertical SMT Single-sided contact

標準タイプ  
Standard type

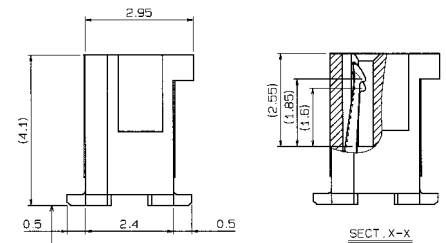
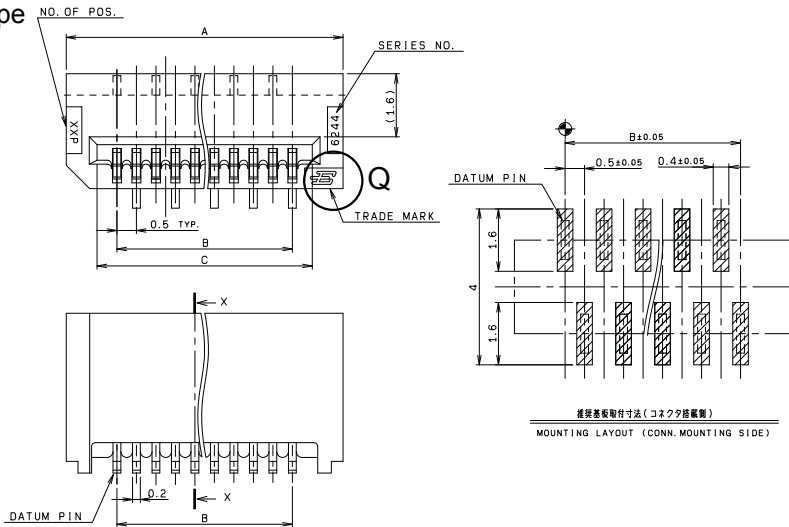

Q部詳細  
DETAIL "Q"



逆千鳥タイプ  
Reverse type

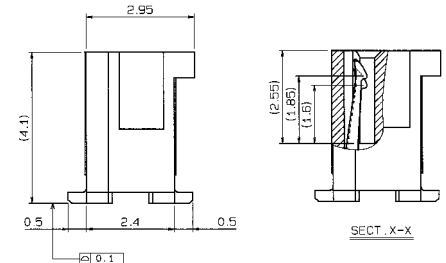
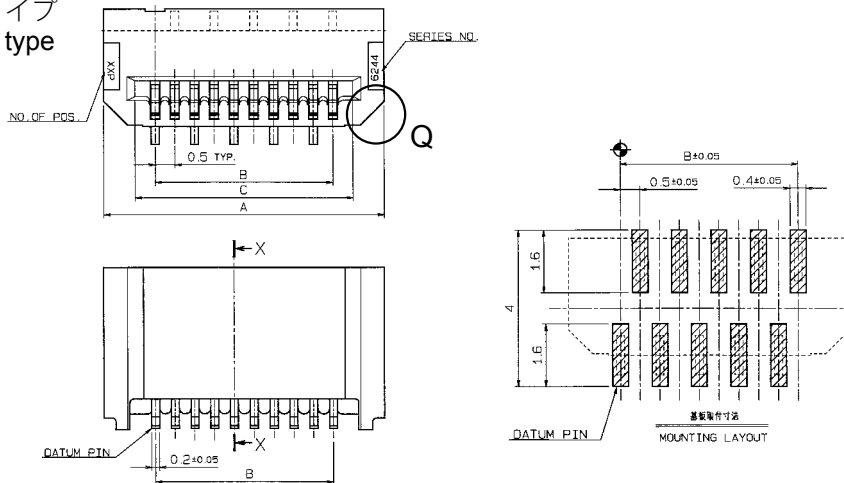

	FPC		FFC	
	1	2	1	2
M	0.5±0.12	0.5±0.1	0.5±0.1	0.5±0.08
P	0.5±0.02	0.5±0.05	0.5±0.03	0.5±0.05
B	B±0.03	B±0.05	B±0.03	B±0.05
W	W±0.07	W±0.07	W±0.07	W±0.07
WD	0.35 <sup>+0.04</sup> <sub>-0.03</sub>	0.35±0.05	0.3 <sup>+0.05</sup> <sub>-0.02</sub>	0.3 <sup>+0.05</sup> <sub>-0.02</sub>

適用FPC, FFC寸法  
APPLICABLE FPC, FFC

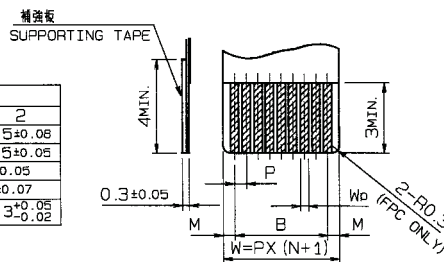

極数 NO OF POS.	A	B	C
6	5.1	2.5	3.6
7	5.6	3.0	4.1
8	6.1	3.5	4.6
9	6.6	4.0	5.1
10	7.1	4.5	5.6
11	7.6	5.0	6.1
12	8.1	5.5	6.6
13	8.6	6.0	7.1
14	9.1	6.5	7.6
15	9.6	7.0	8.1
16	10.1	7.5	8.6
17	10.6	8.0	9.1
18	11.1	8.5	9.6
19	11.6	9.0	10.1
20	12.1	9.5	10.6
21	12.6	10.0	11.1
22	13.1	10.5	11.6
23	13.6	11.0	12.1
24	14.1	11.5	12.6
25	14.6	12.0	13.1
26	15.1	12.5	13.6
27	15.6	13.0	14.1
28	16.1	13.5	14.6
29	16.6	14.0	15.1
30	17.1	14.5	15.6

注文コード ORDERING CODE

04 6244 4XX 0XX XXX+

RoHS 対応品

RoHS Compliant Product

800+: スズ銅めっき Sn-Cu Plated  
846+: 金めっき Au Plated

0: 標準タイプ Standard type

1: 逆千鳥タイプ Reverse type

0: Q部 片側C面タイプ "Q" One side chamfer type

1: Q部 両側C面タイプ "Q" Both side chamfer type

極数 NUMBER OF POSITIONS

生産対応可能極数については、営業部に  
ご確認願います。

Feel free to contact our sales department  
for available numbers of positions.

0.5mm Pitch  
SERIES

# 6244

エンボス梱包品  
Tape and Reel Package

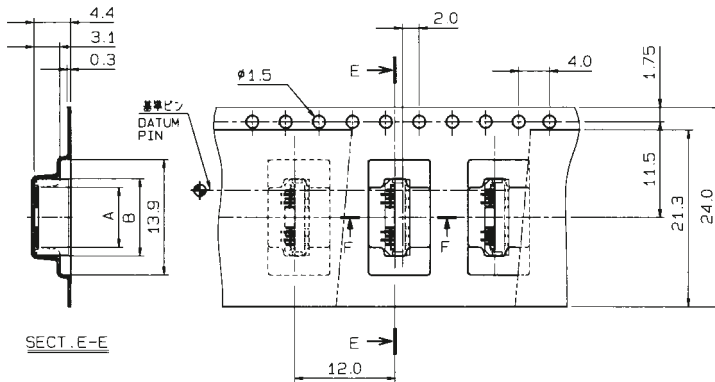

極数 NO. OF POS	A	B
6	3.2	5.3
7	3.7	5.8
8	4.2	6.3
9	4.7	6.8
10	5.2	7.3
11	5.7	7.8
12	6.2	8.3
13	6.7	8.8
14	7.2	9.3
15	7.7	9.8
16	8.2	10.3
17	8.7	10.8
18	9.2	11.3
19	9.7	11.8

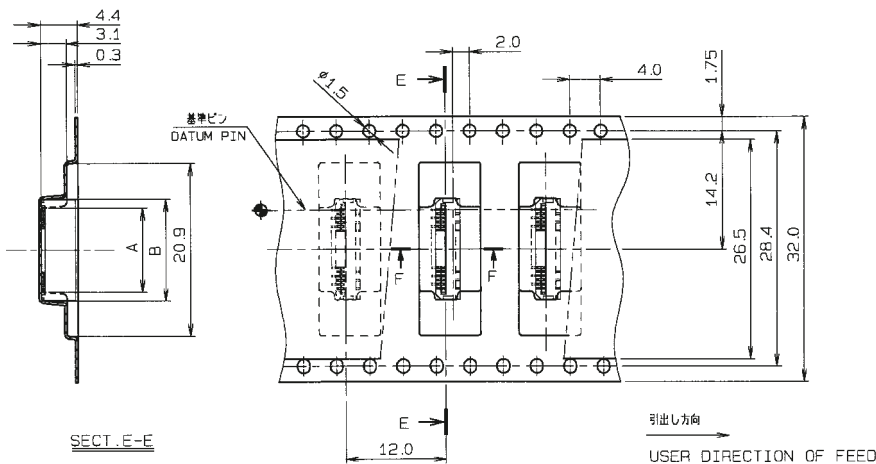

極数 NO. OF POS	A	B
20	10.2	12.3
21	10.7	12.8
22	11.2	13.3
23	11.7	13.8
24	12.2	14.3
25	12.7	14.8
26	13.2	15.3
27	13.7	15.8
28	14.2	16.3
29	14.7	16.8
30	15.2	17.3

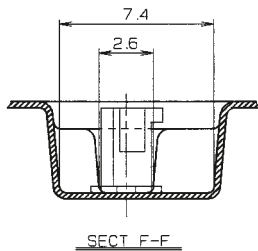

注文コード ORDERING CODE

04 6244 4XX 0XX XXX+

RoHS 対応品

RoHS Compliant Product

800+ : スズ銅めっき Sn-Cu Plated  
846+ : 金めっき Au Plated

0 : 標準タイプ Standard type  
1 : 逆千鳥タイプ Reverse type

0 : Q部 片側C面タイプ "Q" One side chamfer type  
1 : Q部 両面C面タイプ "Q" Both side chamfer type

極数 NUMBER OF POSITIONS

生産対応可能極数については、営業部にご確認願います。

Feel free to contact our sales department for available numbers of positions.

梱包数量 1500個/リール  
PACKING QUANTITY 1500/Reel