

Description: 698-960/1710-3800MHz Stick Antenna with RA SMA connector

Series: Stick Antenna

PART NUMBER: W1096X



Features:

- 4G/5G Stick Antenna
- Performance across the LTE frequency bands
- 698-960/1710-2690/3400-3800 MHz
- Up to 2 dBi Gain
- Right Angle SMA or RP SMA Male connector
- IP65

Applications:

- 4G / 5G Radios
- Router, Hub or Access point
- Small Base Station
- Femto Cell
- SOHO

All dimensions are in mm / inches

Issue: 2033

In the effort to improve our products, we reserve the right to make changes judged to be necessary.

CONFIDENTIAL AND PROPRIETARY INFORMATION

This document contains confidential and proprietary information of Pulse Electronics, Inc. (Pulse) and is protected by copyright, trade secret and other state and federal laws. Its receipt or possession does not convey any rights to reproduce, disclose its contents, or to manufacture, use or sell anything it may describe. Reproduction, disclosure or use without specific written authorization of Pulse is strictly forbidden.

For more information:

Pulse Worldwide Headquarters
15255 Innovation Drive #100
San Diego, CA 92128
USA
Tel: 1-858-674-8100

Pulse/Larsen Antennas
18110 SE 34th St Bldg 2 Suite 250
Vancouver, WA 98683
USA
Tel: 1-360-944-7551

Europe Headquarters
Pulse GmbH & Do, KG
Zeppelinstrasse 15
Herrenberg, Germany
Tel: 49 7032 7806 0

Pulse (Suzhou) Wireless Products Co, Inc.
99 Huo Ju Road(#29 Bldg,4th Phase
Suzhou New District
Jiangsu Province, Suzhou 215009 PR China
Tel: 86 512 6807 9998



Description: 698-960/1710-3800MHz Stick Antenna with RA SMA connector

Series: Stick Antenna

PART NUMBER: W1096X

This document covers all product variants of the following product family

Antennas	Connector
W1096	RA RP SMA Male
W1096RM	RA SMA Male

Description: 698-960/1710-3800MHz Stick Antenna with RA SMA connector

Series: Stick Antenna

PART NUMBER: W1096X

ELECTRICAL SPECIFICATIONS

Antenna Type	Monopole antenna
Frequency	698-960/1710-2690/3400-3800 MHz
Nominal Impedance	50 Ω
VSWR(Max)	3.5:1 / 2:1 / 4:1
Radiation Pattern	Omni
Gain 698-960MHz	>-3 dBi
Gain 1710-2690MHz	>1.5 dBi
Gain 3400-3800MHz	>-0.5 dBi
Efficiency 698-960MHz	>30 %
Efficiency 1710-2690MHz	>60 %
Efficiency 3400-3800MHz	>45 %
Polarization	Linear
Power Withstanding	3 W

MECHANICAL SPECIFICATIONS

Overall Length	112±3mm
Weight	13g
Antenna Color / Material	Black
Connector type	W1096: Right Angle RP SMA Male, Silver Ni plating W1096RM: Right Angle SMA Male, Silver Ni plating

ENVIRONMENTAL SPECIFICATIONS

Operating Temperature	-40 °C to +80 °C
Storage Temperature	-40 °C to +80 °C
Ingress Protection	IP65
RoHS Compliant	Yes

Description: 698-960/1710-3800MHz Stick Antenna with RA SMA connector

Series: Stick Antenna

PART NUMBER: W1096X

MECHANICAL DRAWING

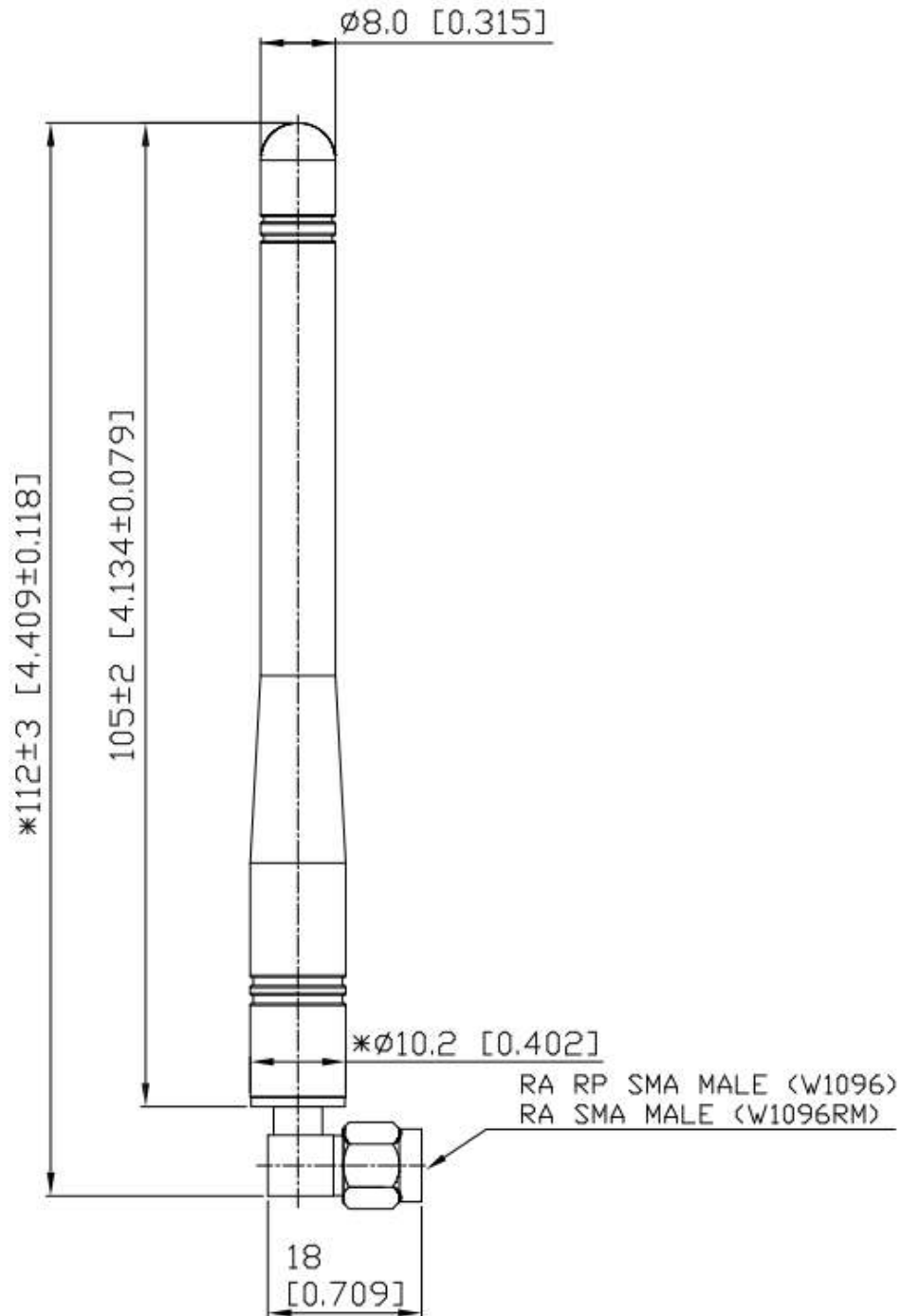

Issue: 2033

In the effort to improve our products, we reserve the right to make changes judged to be necessary.

CONFIDENTIAL AND PROPRIETARY INFORMATION

This document contains confidential and proprietary information of Pulse Electronics, Inc. (Pulse) and is protected by copyright, trade secret and other state and federal laws. Its receipt or possession does not convey any rights to reproduce, disclose its contents, or to manufacture, use or sell anything it may describe. Reproduction, disclosure or use without specific written authorization of Pulse is strictly forbidden.

Description: 698-960/1710-3800MHz Stick Antenna with RA SMA connector

Series: Stick Antenna

PART NUMBER: W1096X

TEST SETUP

ground plane

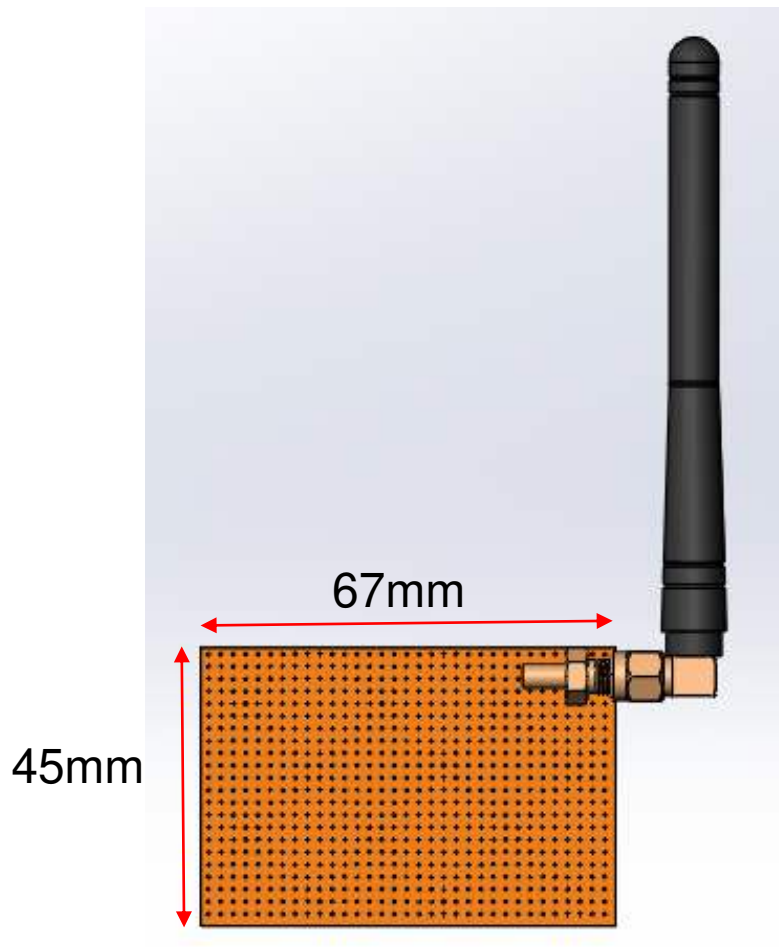

Issue: 2033

In the effort to improve our products, we reserve the right to make changes judged to be necessary.

CONFIDENTIAL AND PROPRIETARY INFORMATION

This document contains confidential and proprietary information of Pulse Electronics, Inc. (Pulse) and is protected by copyright, trade secret and other state and federal laws. Its receipt or possession does not convey any rights to reproduce, disclose its contents, or to manufacture, use or sell anything it may describe. Reproduction, disclosure or use without specific written authorization of Pulse is strictly forbidden.

Description: 698-960/1710-3800MHz Stick Antenna with RA SMA connector

Series: Stick Antenna

PART NUMBER: W1096X

TEST SETUP

VSWR:

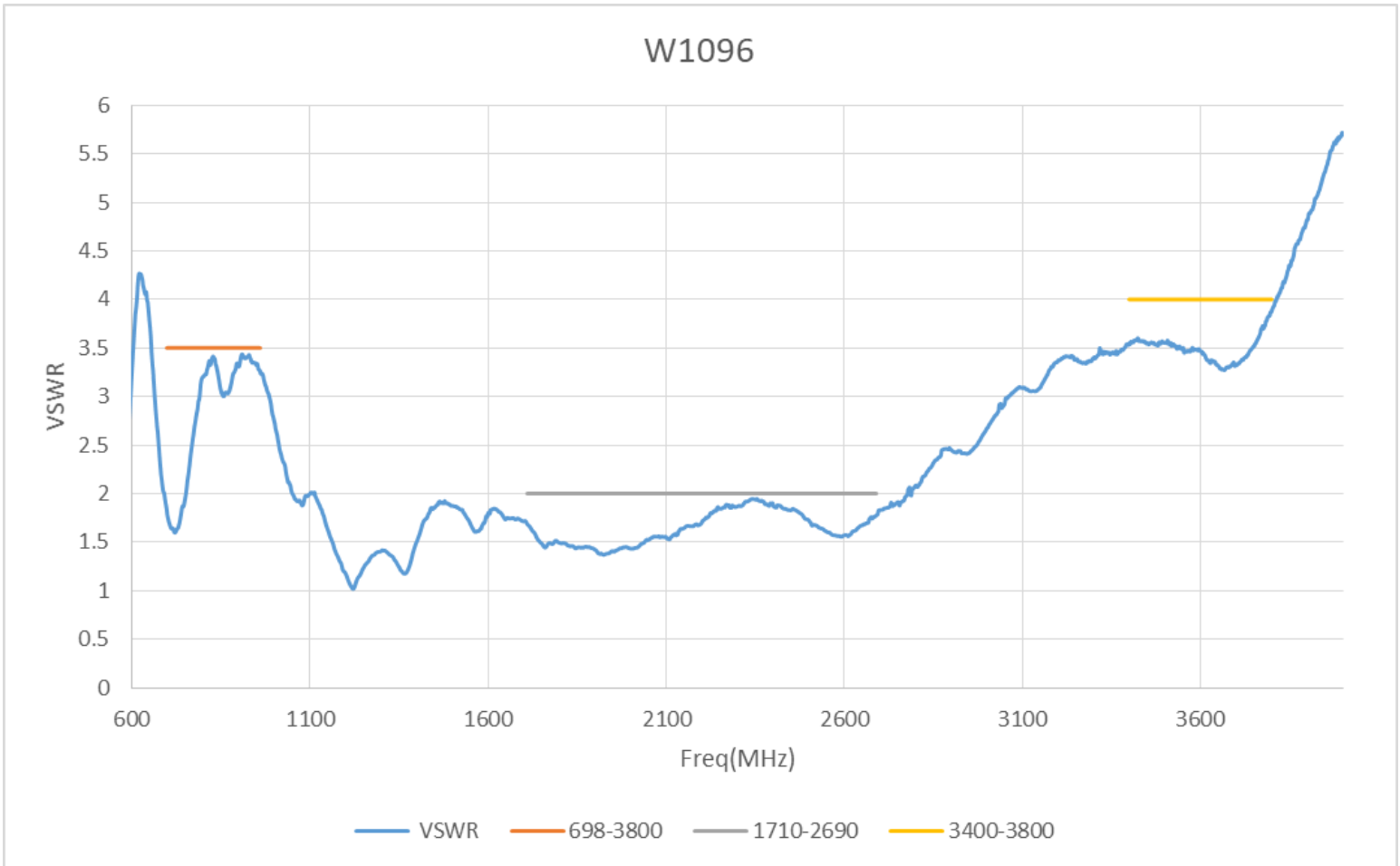

Issue: 2033

In the effort to improve our products, we reserve the right to make changes judged to be necessary.

CONFIDENTIAL AND PROPRIETARY INFORMATION

This document contains confidential and proprietary information of Pulse Electronics, Inc. (Pulse) and is protected by copyright, trade secret and other state and federal laws. Its receipt or possession does not convey any rights to reproduce, disclose its contents, or to manufacture, use or sell anything it may describe. Reproduction, disclosure or use without specific written authorization of Pulse is strictly forbidden.

Description: 698-960/1710-3800MHz Stick Antenna with RA SMA connector

Series: Stick Antenna

PART NUMBER: W1096X

Total radiated Efficiency

Efficiency curve:

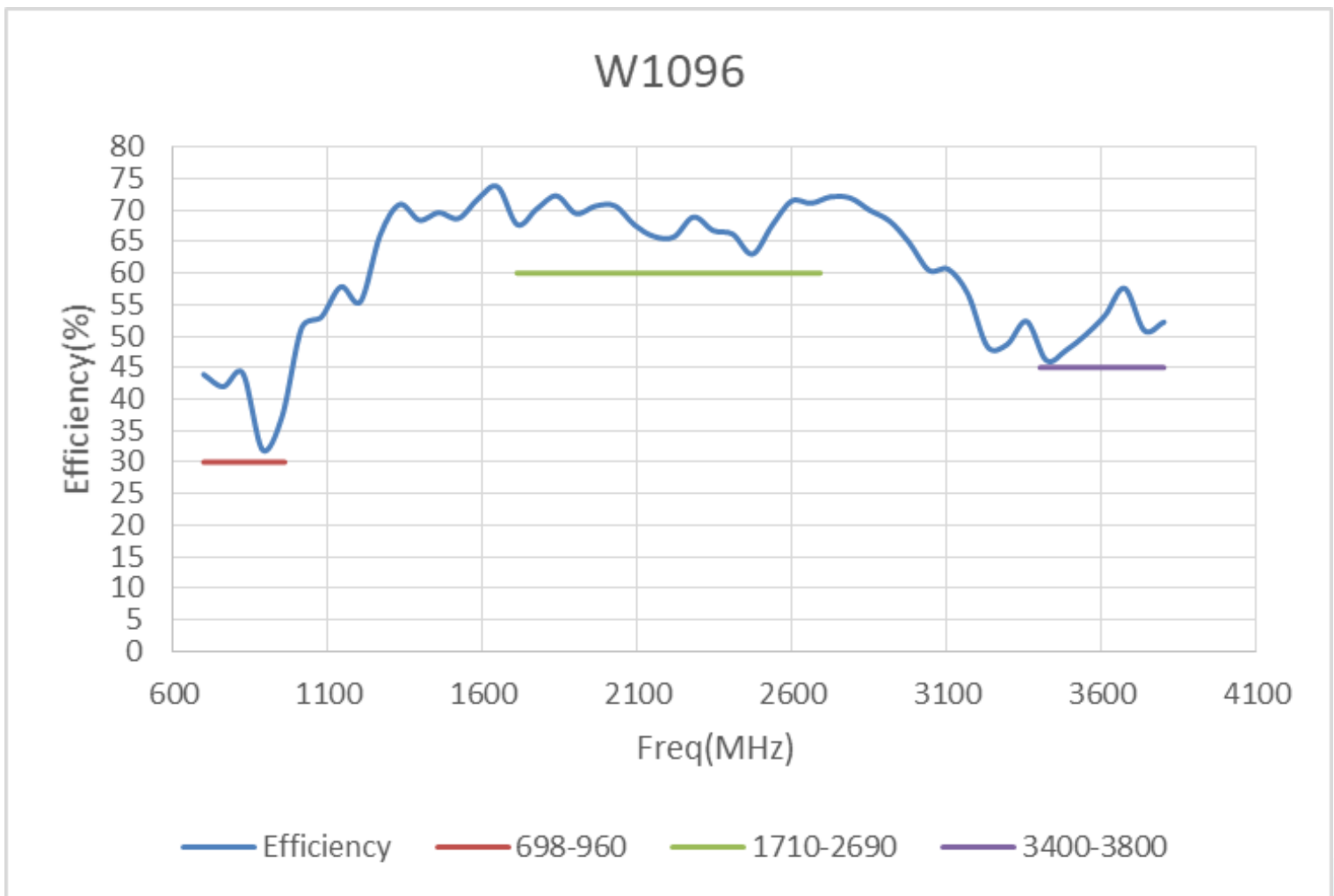

Description: 698-960/1710-3800MHz Stick Antenna with RA SMA connector

Series: Stick Antenna

PART NUMBER: W1096X

Maximum peak Gain

Peak gain curve:

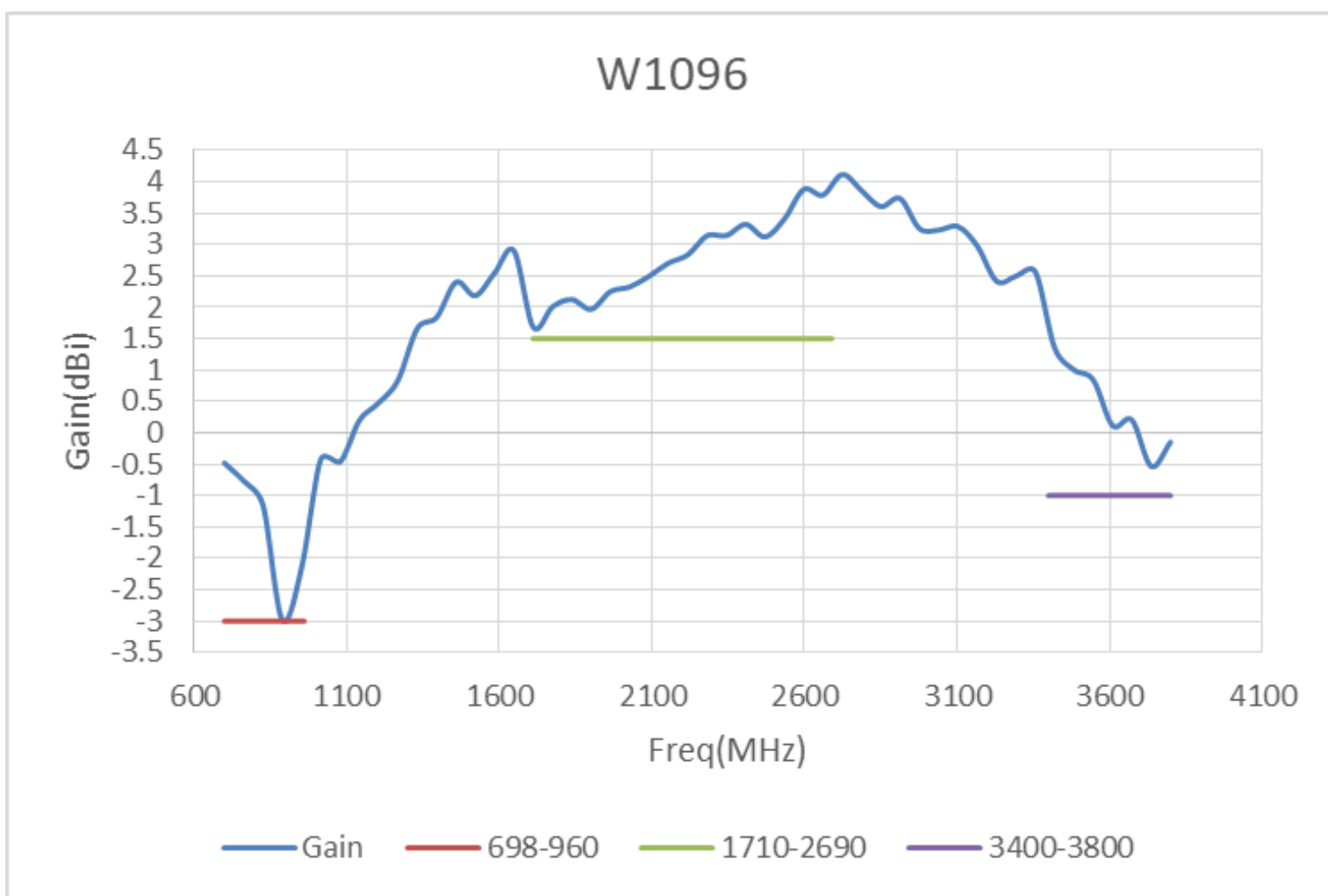

Description: 698-960/1710-3800MHz Stick Antenna with RA SMA connector

Series: Stick Antenna

PART NUMBER: W1096X

CHARTS

Curves at 698, 829 and 960MHz :

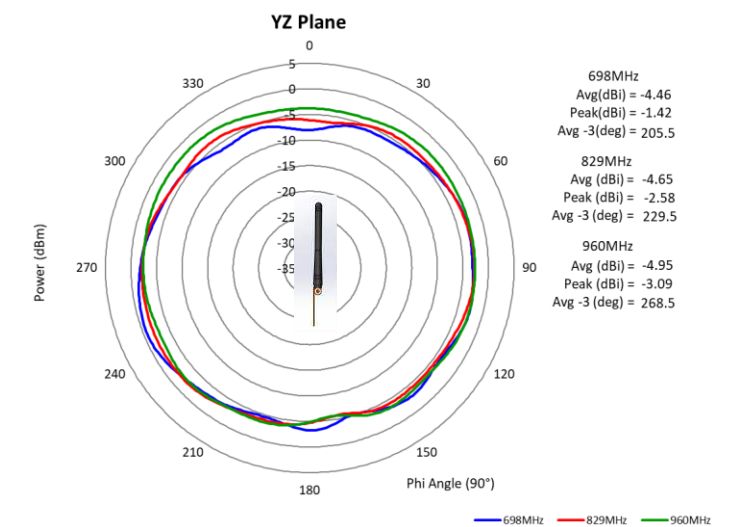
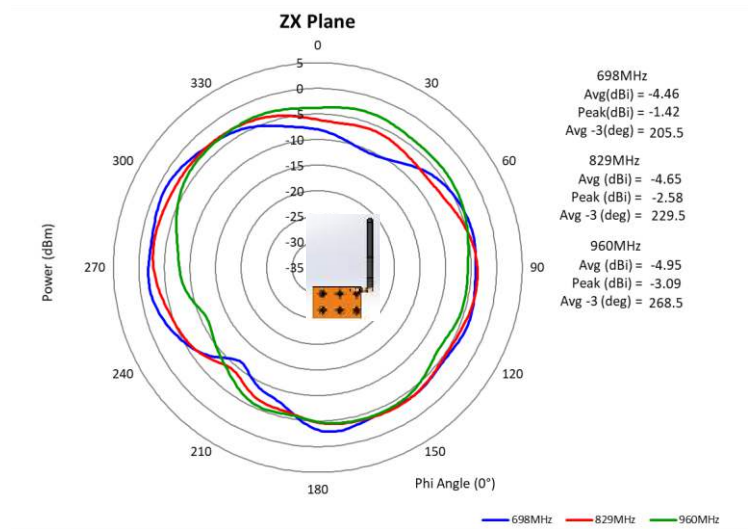
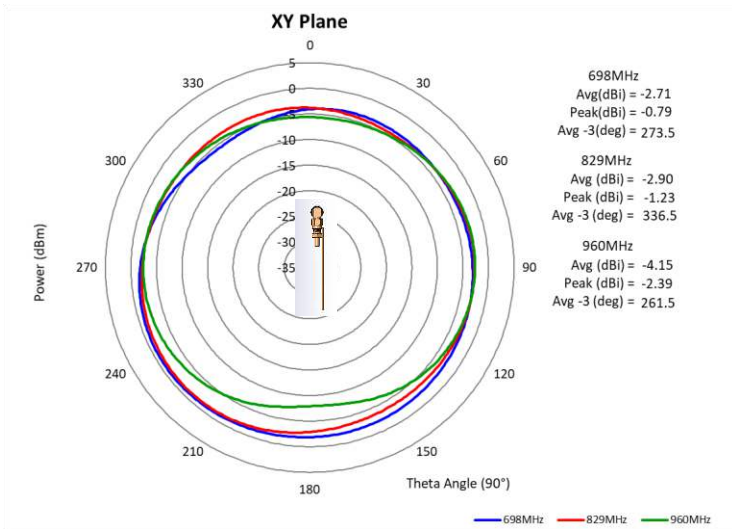

Issue: 2033

In the effort to improve our products, we reserve the right to make changes judged to be necessary.

CONFIDENTIAL AND PROPRIETARY INFORMATION

This document contains confidential and proprietary information of Pulse Electronics, Inc. (Pulse) and is protected by copyright, trade secret and other state and federal laws. Its receipt or possession does not convey any rights to reproduce, disclose its contents, or to manufacture, use or sell anything it may describe. Reproduction, disclosure or use without specific written authorization of Pulse is strictly forbidden.

Description: 698-960/1710-3800MHz Stick Antenna with RA SMA connector

Series: Stick Antenna

PART NUMBER: W1096X

CHARTS

Curves at 1710, 2200 and 2690MHz:

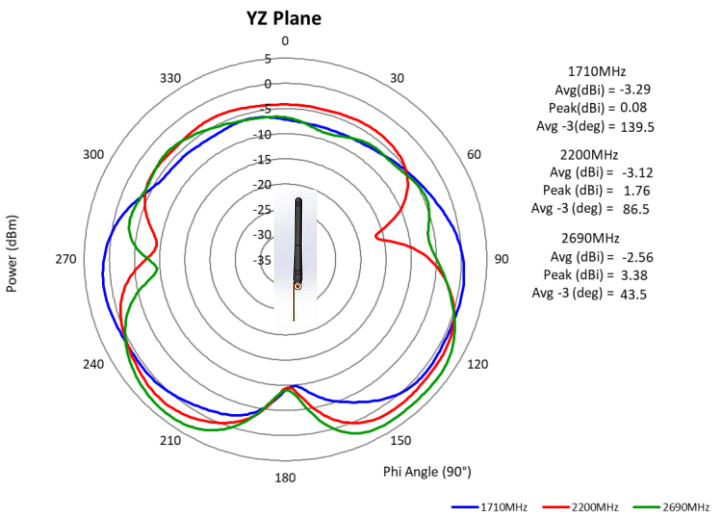
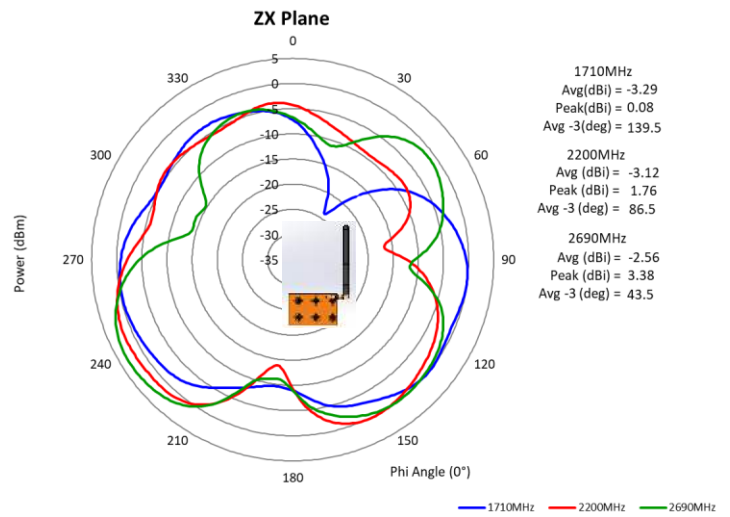
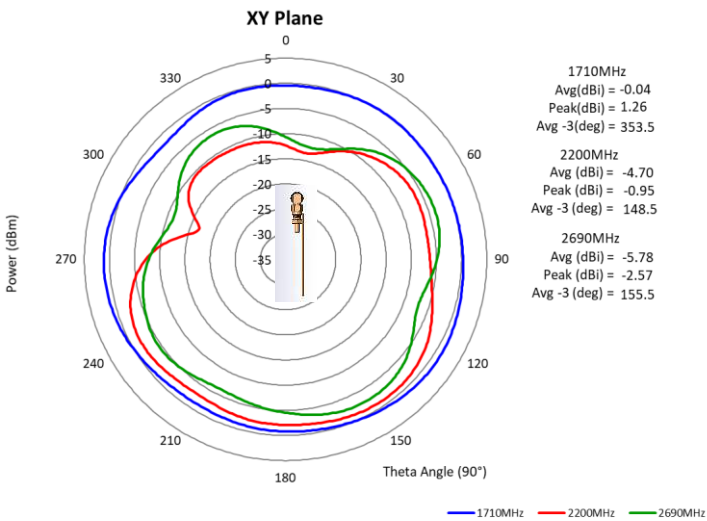

Issue: 2033

In the effort to improve our products, we reserve the right to make changes judged to be necessary.

CONFIDENTIAL AND PROPRIETARY INFORMATION

This document contains confidential and proprietary information of Pulse Electronics, Inc. (Pulse) and is protected by copyright, trade secret and other state and federal laws. Its receipt or possession does not convey any rights to reproduce, disclose its contents, or to manufacture, use or sell anything it may describe. Reproduction, disclosure or use without specific written authorization of Pulse is strictly forbidden.

Description: 698-960/1710-3800MHz Stick Antenna with RA SMA connector

Series: Stick Antenna

PART NUMBER: W1096X

CHARTS

Curves at 3400,3600 and 3800MHz :

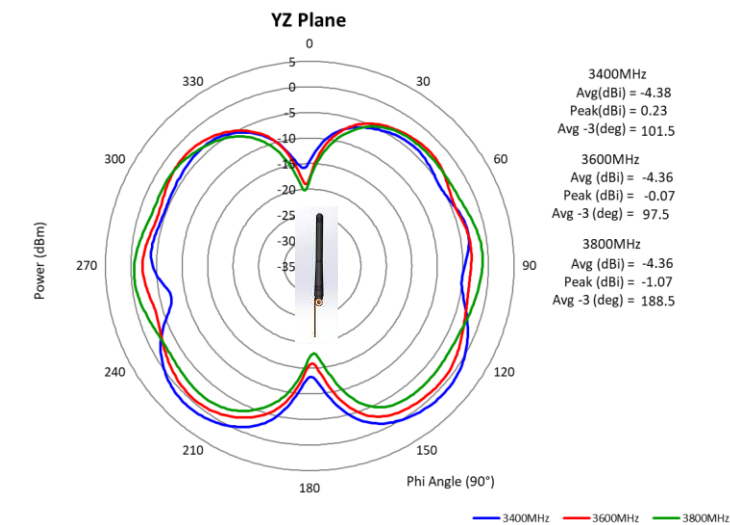
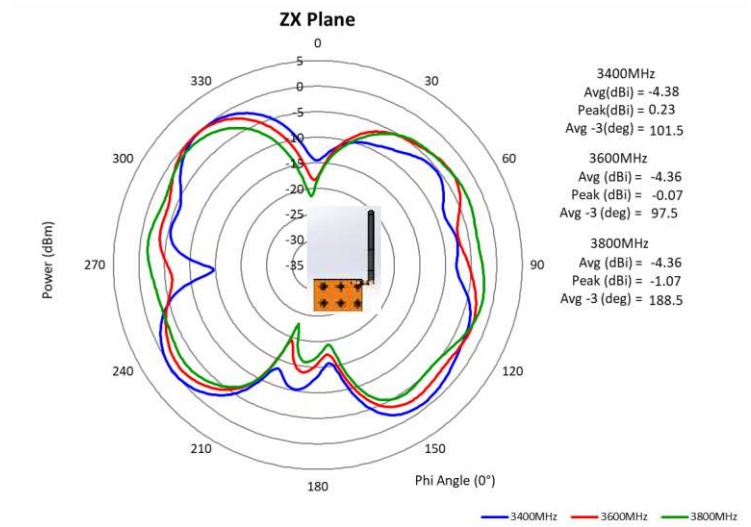
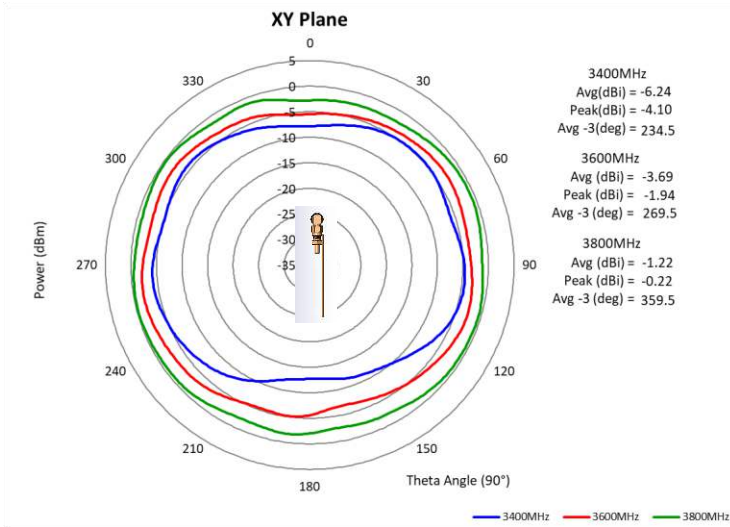

Issue: 2033

In the effort to improve our products, we reserve the right to make changes judged to be necessary.

CONFIDENTIAL AND PROPRIETARY INFORMATION

This document contains confidential and proprietary information of Pulse Electronics, Inc. (Pulse) and is protected by copyright, trade secret and other state and federal laws. Its receipt or possession does not convey any rights to reproduce, disclose its contents, or to manufacture, use or sell anything it may describe. Reproduction, disclosure or use without specific written authorization of Pulse is strictly forbidden.

Description: 698-960/1710-3800MHz Stick Antenna with RA SMA connector

Series: Stick Antenna

PART NUMBER: W1096X

PACKAGING



20pcs ants each small bag

Item	QTY
Each small bag	20pcs
Each big bag	400pcs(20pcs small bags)
Each box	2000pcs